

LIGHTING  
2022 · 2023



CATALISTINO N° 10



CENTURY®  
CENTURY®  
**CENTURY®**  
CENTURY®  
CENTURY®

Illuminiamo le tue idee.



CENTURY

Dedicato al nostro Direttore

Renzo Barbisan



PANNELLI  
**24 - 57**

INCASSO  
**58 - 83**

PLAFONIERE  
**84 - 99**

SISTEMI LINEARI  
**100 - 145**

SOSPENSIONI INDUSTRIALI  
**146 - 151**

PROIETTORI  
**152 - 163**

ARREDO URBANO  
**164 - 169**

OUTDOOR  
**170 - 221**

DECORATIVO  
**222 - 279**

WORK  
**280 - 287**

SORGENTI  
**288 - 343**

GO SMART  
**344 - 355**

BLISTER  
**356 - 375**

ESPOSITORI  
**376 - 379**



- 4** PHOTO INDEX
- 10** NEW
- 16** CENTURY

Century Italia è fornitore a livello internazionale di soluzioni illuminotecniche. Progettando e innovando continuamente, ci impegniamo a portare il meglio in ogni casa, famiglia e organizzazione per un mondo sempre più efficiente e sostenibile.

Century Italia is international supplier of lighting solutions. By continually designing and innovating, we are committed to bringing the best to every home, family and organization for an increasingly efficient and sustainable world.

INDICE FOTOGRAFICO  
INDICE FOTOGRAFICO  
**INDICE FOTOGRAFICO**  
INDICE FOTOGRAFICO  
INDICE FOTOGRAFICO

PHOTO INDEX  
PHOTO INDEX  
**PHOTO INDEX**  
PHOTO INDEX  
PHOTO INDEX

## Indice fotografico - Photo Index

### PANNELLI

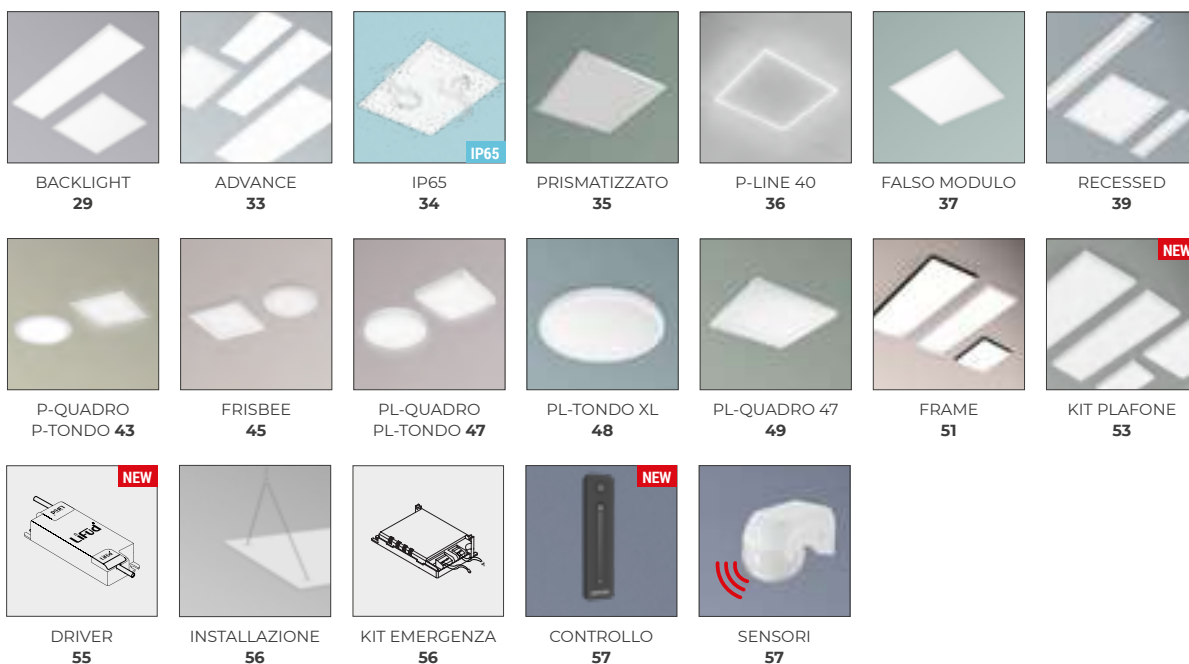

### INCASSO



### SUPPORTI INCASSO

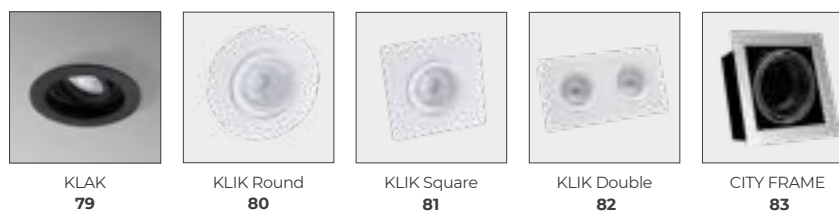

### PLAFONIERE

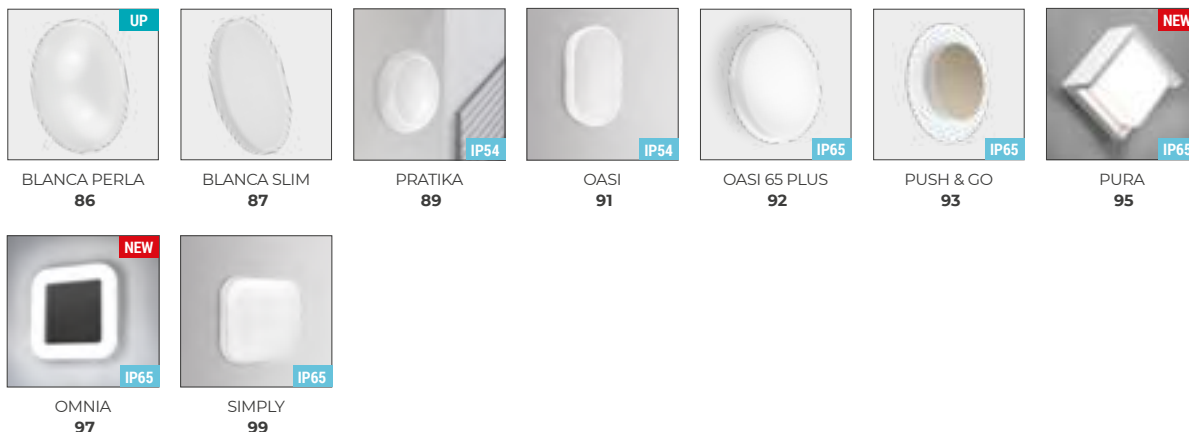

## Indice fotografico - Photo Index

### SIST. LINEARI STRIP LED

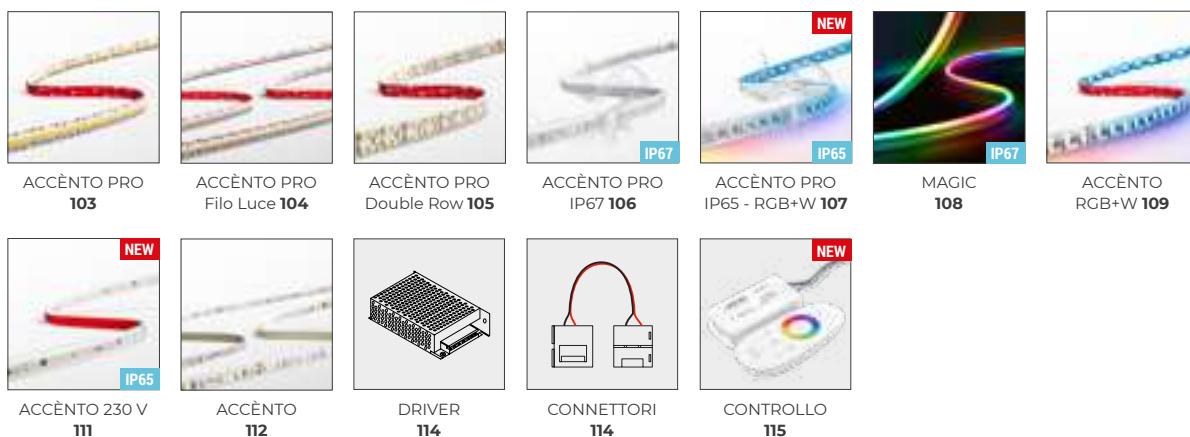

### SIST. LINEARI PROFILI

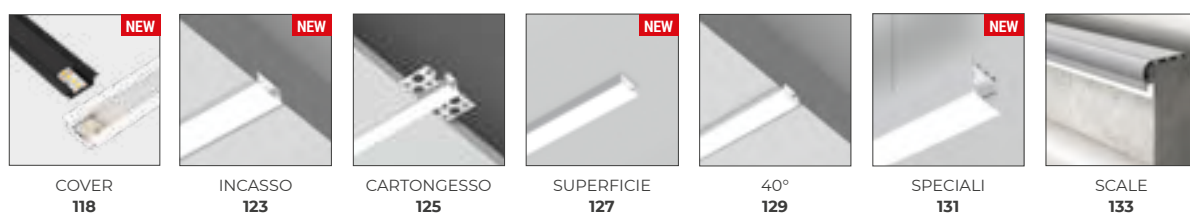

### SIST. LINEARI PLAFONIERE

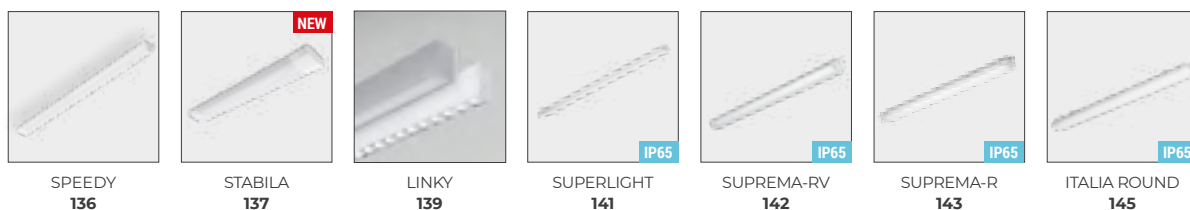

### SOSPENSIONI INDUSTRIALI



### PROIETTORI



### ARREDO URBANO



### OUTDOOR GARDEN

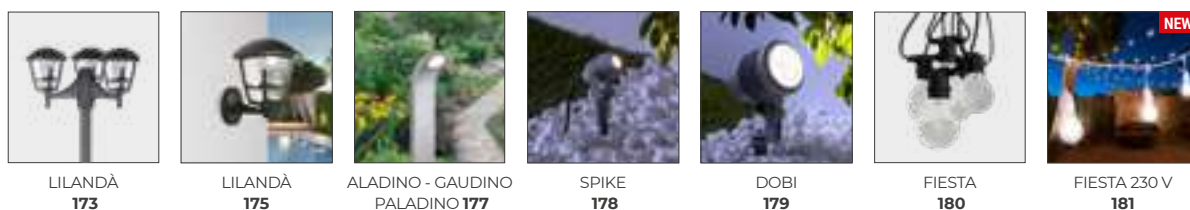

## Indice fotografico - Photo Index

### OUTDOOR CALPESTABILI



PAVI  
185



LINEA PAVI  
186



PAVI GIUO  
187



PAVI  
189

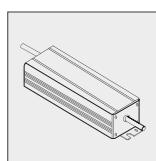

DRIVER  
191

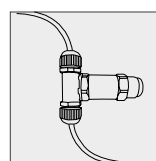

CONNETTORI  
191

### OUTDOOR SOLARI



ARCADIA  
195



GENIUS  
197



SIRIO SOLAR  
198

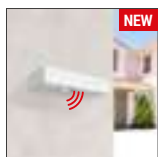

DOMINO  
199



DVERSO 5 W  
200



DVERSO 10 W  
201



LEVANTE  
203

### OUTDOOR DECORATIVO

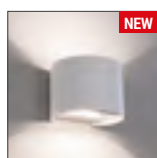

UP & DOWN +  
207



UP & DOWN  
208



FORMA  
209

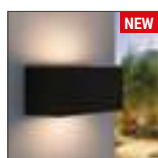

REVERSO  
211

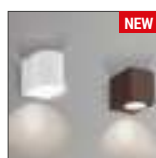

AXO  
213



AXO  
215

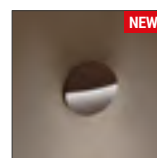

PASEO  
217



CORTÈS  
218

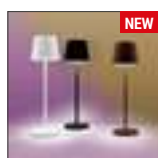

LUME PLUS  
221

### INDOOR DECORATIVO

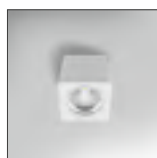

QUBE  
225



RONDÒ  
225



QUBE - RONDÒ  
STYLO 227



ENFASI STYLO  
229



ENFASI SQUARE  
231



ENFASI ROUND  
233



ESSENZA QUBE  
235



ESSENZA RONDÒ  
237



ESSENZA  
ORIENTABILE 239



FANTASY  
240



FUSION 150  
241



COLORFULL  
243

### GESSI



JESSY Square  
247



JESSY Round  
251

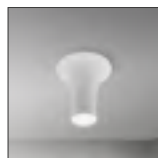

KONI70  
252

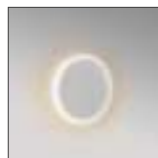

ECLISSI  
253

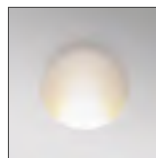

JESSY BOLLE  
255



MIRO200  
255



DALI310  
255



SOFFIO  
257

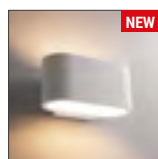

JESSY APPLIQUE  
259

## Indice fotografico - Photo Index

### EMERGENZA



SICURA LED  
263



PRATIKA  
264



ITALIA ROUND  
264



CORTÈS  
264



COMODA  
265

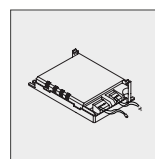

KIT EMERGENZA  
265

### DECORATIVO TRACK LIGHT



BINARY  
269



CONNETTORI  
270



REGIA SHOP GU10  
272



REGIA SHOP 180  
273



REGIA SHOP  
Dimm. 275



REGIA SHOP  
LINEARE 276



REGIA BINARIO  
277



REGIA MINI  
279

### WORK



JOLLY  
283



FOCUS  
284



REWORK  
285

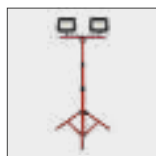

REWORK Treppiedi  
285



FREE WORK  
287

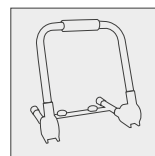

SUPPORTI  
287

### SORGENTI FILAMENTO



INCANTO CLEAR  
Goccia 292



INCANTO SATEN  
Goccia 293



INCANTO CLEAR  
Globo 294



INCANTO SATEN  
Globo 295



INCANTO CLEAR  
296



INCANTO SATEN  
297



INCANTO  
Dimmerabile 298



INCANTO  
Tubolare 300



INCANTO SATEN  
Saphir 301



INCANTO SILVER  
303



INCANTO EPOCA  
304



INCANTO EPOCA  
305



INCANTO EPOCA XL  
305

### SORGENTI CLASSICHE



HARMONY 95  
Globo Dimm. 307



HARMONY 80  
308



HARMONY 80  
Globo Dimm. 309



ONDA  
310



ARIA PLUS  
311



ARIA PLUS Dimm.  
311

### SORGENTI SPOT



LEXAR  
313



DICRO SHOP 95  
314



DICRO SHOP 90  
314



SPOT MULTILED  
315



SPOT MAXILED  
315



## Indice fotografico - Photo Index

### SORGENTI SPECIALI



PIXY G4  
318



PIXY G9  
319



PIXY Dimm.  
320



TRE-D  
321



ARIA PLUS 12-24 V  
322



SENSOR  
323

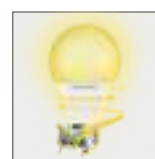

KILLER 50  
325



LAMPADA FRIGO  
326



LAMPADA VOTIVA  
326



CIRCOLINA  
326



FLAME  
327

### SORGENTI PROFESSIONALI



LOTUS  
329



PLOSE  
331



MAXIMA  
333



MAXIMA Round  
333



SERIE LIGHT  
334



SERIE LIGHT  
335



PAR SHOP  
336



PAR56  
337



PL-COVER  
338



GXLED  
339

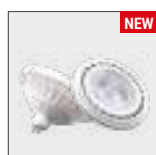

CITY LAMP  
340



SUPER LED  
341



TUBI LED



FULL VISION  
343

### GO SMART



LAMPADA SMART  
349



ACCÈNTO SMART  
350



CONTROLLER RGB+W  
351



BLANCA SMART  
352



SPOTFIVE SMART  
353



INTERRUTTORE  
SMART 354



SMART POWER  
355

### BLISTER



INCANTO CLEAR  
358



INCANTO SATEN  
360



SENSOR  
362



ARIA PLUS  
363



ECOLINE  
364



SPOT MAXILED  
366



ACCÈNTO KIT  
367

### VERSATILI



GIARDINETTO  
371



MINI WORK  
372



FUNNY  
372



PENNY  
372



SALLY  
372



MOUSE  
373



TOMMY  
373



ITALO  
373



NEMO  
373



TERRY  
373



SOLIDEA  
373



COMODA  
374



SEGNALATORI  
375



ACCESSORI - PANNELLI  
**KIT PLAFONE**

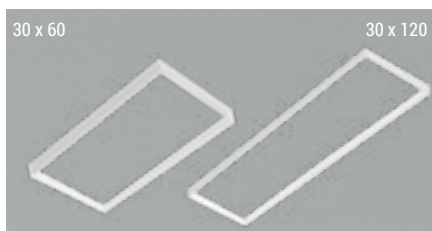

53

**CONTROLLO**



57

INCASSO  
**ZENO**

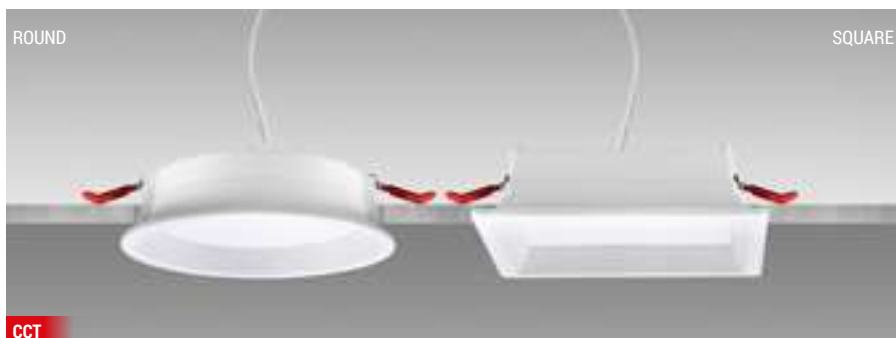

61

INCASSO  
**LINEA-R**



DIMMERABILE

75

PLAFONIERE  
**PURA**



95

**OMNIA**



PIASTRE INTERCAMPBILI

97

SISTEMI LINEARI - STRIP LED  
**ACCÈNTO PRO IP65 - RGB+W**



107

**ACCÈNTO 230 V**



111



SISTEMI LINEARI - PROFILI  
**COVER E FINITURE**



118

**PROFILI**

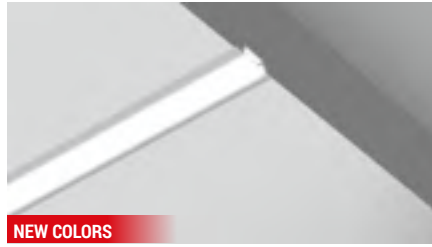

NEW COLORS

123

SOSPENSIONI INDUSTRIALI  
**DISCOVERY MAX**



151

PROIETTORI  
**SIRIO SLIM**



NEW WATT

155

**SIRIO BT**



12-36 V/DC

156

**PORTEO**



CCT

161

OUTDOOR - GARDEN  
**FIESTA 230 V**



15 x E27

181

OUTDOOR - SOLARI  
**GENIUS**



197

**SIRIO SOLAR**



198

**DOMINO**



199



OUTDOOR - DECORATIVO  
**UP & DOWN +**



207

**REVERSO**



211

**AXO**



213

**PASEO**

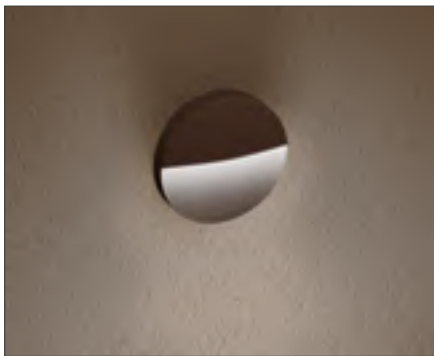

217

**LUME PLUS**



221

GESSI  
**JESSY**



259

DECORATIVO - TRACK LIGHT  
**CONNETTORI**



270

**REGIA MINI**



279

ZZZZ  
EEEE  
VVVV

WORK  
**JOLLY**



283

SORGENTI - FILAMENTO

### INCANTO



NEW WATT

292

### INCANTO



DIMMERABILE

298

### SILVER



SILVER DOME

303

SORGENTI - SPOT

### LEXAR



CERAMIC

313

SORGENTI - SPECIALI

### PIXY



DIMMERABILE

320

### TRE-D



COB

321



SORGENTI - PROFESSIONALI

### PLOSE



E40

331

### CITY LAMP



GU10

340

BLISTER

### INCANTO



NEW WATT

359

VERSATILI

### GIARDINETTO



371

### SEGNALATORI



375

# Il nuovo sistema di informazione tecnica

## Tabelle, simboli e dati tecnici più chiari ed intuitivi

### Come leggere il catalogo / How to read catalogue



Disegno tecnico Technical draw	Potenza Power	Lumen		Angolo luce Beam angle	Caratteristica Main feature	Finitura Finish	Colore luce Light Color	Codice prodotto Product code	Inner / Master	Prezzo / Price
		SOURCE	OUTPUT							
	20 W	1.700 lm	1.600 lm	38° ∠	UGR<19 - CRI 90	Bianco / White ○	3000K	<b>RGT180BI-207030</b>	1/6	€ 58,00
							4000K	<b>RGT180BI-207040</b>		
						Nero / Black ●	3000K	<b>RGT180NE-207030</b>		
							4000K	<b>RGT180NE-207040</b>		
	35 W	3.100 lm	2.800 lm	38° ∠	UGR<19 - CRI 90	Bianco / White ○	3000K	<b>RGT180BI-359030</b>	1/6	€ 79,00
							4000K	<b>RGT180BI-359040</b>		
						Nero / Black ●	3000K	<b>RGT180NE-359030</b>		
							4000K	<b>RGT180NE-359040</b>		

Tabella misure e peso / Size and weight table

Rotazione su asse / Rotation on axis

Inclinazione su asse / Inclination on axis

I lumen sorgente sono misurati appena la luce esce dal diodo di emissione.  
I lumen output sono misurati fuori dalla lampada considerando così le dispersioni causate dalle ottiche, dagli schermi e le riflessioni.

Source lumen are measured as light exits the emitting diode.  
Output lumen are measured outside the lamp thus considering the dispersions caused by optics, screens and reflections.

Il presente documento potrebbe includere inesattezze tecniche o errori tipografici che verranno corretti a esclusiva discrezione della CENTURY non appena rilevati. CENTURY si riserva inoltre il diritto di variare i contenuti del catalogo in qualsiasi momento, senza preavviso. Le misure, se non espressamente specificato, sono da considerarsi in millimetri.

This document may include technical inaccuracies or typographical errors which will be corrected at CENTURY's sole discretion as soon as detected. CENTURY also reserves the right to change the contents of the catalog at any time, without notice. The measurements, if not expressly specified, are to be considered in millimeters.



# The new technical information system Clearer and more intuitive tables, symbols and technical data

## Nuova etichetta energetica / New energy label

Dal 1° settembre 2021 entra in vigore la nuova etichetta energetica riscalata per rendere più chiaro al consumatore quali sono i prodotti più efficienti sul mercato.

La nuova scala di valori (da A a G) è diversa da quella precedente e, a parità di classe energetica, sono richieste prestazioni molto più elevate.

Non esistono più, ad esempio, le classi A+ e A++ e i relativi prodotti sono stati riclassificati in classi più basse, mentre la nuova classe A (210 lm/w) richiede un'efficienza quasi doppia rispetto alla precedente classe A++ (120 lm/w).

Una novità di sicuro interesse è l'aggiunta di un QR Code che consentirà agli utenti di accedere alle informazioni della sorgente luminosa registrate sul database EPREL (European Product Registry for Energy Labelling) mediante il sito Web di pubblico accesso per comparare e consultare specifiche tecniche del prodotto.

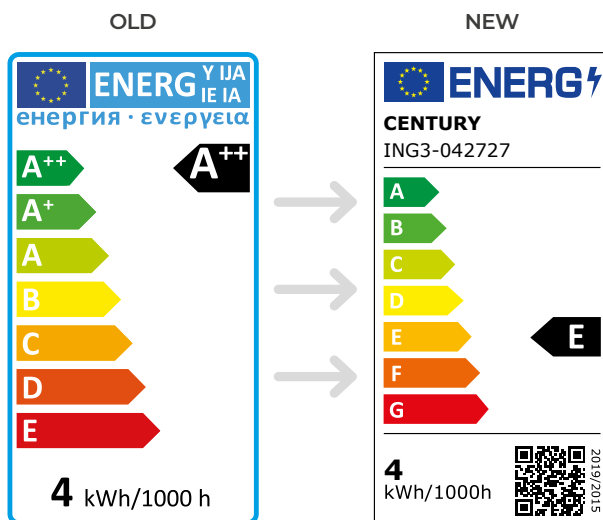

CLASS	lm / W
A++	120
A+	75
A	55
B	22
C	16
D	13
E	<13

CLASS	lm / W
A	210
B	185
C	160
D	135
E	110
F	85
G	<85

From 1<sup>st</sup> September 2021 the new rescaled energy label comes into force to make the product efficiency concept into consumer mind clearer.

The new scale of values (from A to G) is different from the previous ones and with the same energy class, much higher performance is required.

For example, classes A+ and A++ no longer exist and the related products have been reclassified into lower classes, while the new class A (210 lm/w) requires almost double efficiency compared to the previous class A++ (120 lm/w).

An innovation of great interest is the addition of a QR Code that will allow users to access light source information registered on the EPREL database (European Product Registry for Energy Labelling) through a new public access website to compare and refer technical specifications of the product.

## Nuova etichetta ambientale / New environment label

Essere sostenibili è una virtù naturale, proteggere l'ambiente è un impegno concreto che da sempre prendiamo a cuore.

Per ridurre i consumi puntiamo su prodotti innovativi, dalla forte connotazione green, frutto di oculate strategie aziendali. Il nostro obiettivo è il raggiungimento della piena autosufficienza energetica attraverso l'utilizzo di fonti rinnovabili e tecnologie all'avanguardia.

Rispettare l'ambiente significa poter guardare al presente e al futuro con altri occhi.

Per questo abbiamo introdotto, su tutti i nostri packaging, un'etichetta che fornisce informazioni sia sulla composizione degli imballaggi, sia sul loro corretto smaltimento da parte del consumatore.



Being sustainable is a natural virtue, protecting the environment is a concrete commitment that we have always taken to heart.

To reduce consumption, we focus innovative products, with a strong green connotation, the result of accurate company strategies. Our goal is to achieve full energy self-sufficiency through the use of renewable sources and cutting-edge technologies.

Respecting the environment means being able to look at the present and the future with different eyes.

For this reason we have introduced, on all our packaging, a label that provides information both on the composition of the packaging and on its correct disposal by the consumer.





VENTURE  
CENTURY



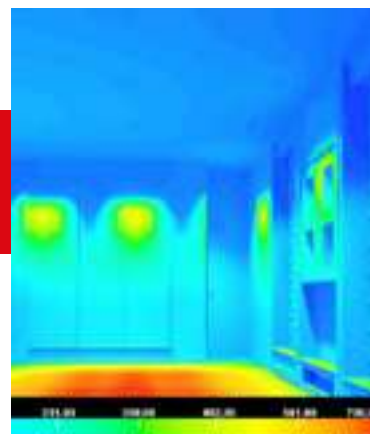

La solidità e la riconoscibilità del brand CENTURY® derivano dalla costante qualità dei prodotti, dalla capacità di innovare e dal saper guardare al domani con spirito sostenibile. Un'equipe di professionisti costantemente alla ricerca dell'eccellenza, sempre pronti ad esplorare nuovi luminosi orizzonti.

The solidity and recognizability of the CENTURY® brand derive from the constant quality of the products, the ability to innovate and the ability to look to tomorrow with a sustainable spirit. A team of professionals constantly in search of excellence, always ready to explore new bright horizons.



CHI SIAMO  
 CHI SIAMO  
**CHI SIAMO**  
 CHI SIAMO  
 CHI SIAMO



Dal 1995 progettiamo e realizziamo soluzioni illuminotecniche che esprimono funzionalità, performance e design. Illuminare per noi vuol dire progettare prodotti all'avanguardia, in grado di coniugare ottime prestazioni e consistente risparmio energetico.

Since 1995 we have been designing and manufacturing lighting solutions that express functionality, performance and design. For us, lighting means designing cutting-edge products, capable of combining excellent performance and substantial energy savings.





ABOUT US  
ABOUT US  
**ABOUT US**  
ABOUT US  
ABOUT US



Solo attraverso un'illuminazione di qualità possiamo guardare il mondo con occhi diversi. Creiamo le migliori soluzioni LED in grado di valorizzare l'ambiente e le sue bellezze.



I valori in cui crediamo sono il nostro marchio di fabbrica: rappresentano le fondamenta sulle quali continuare a costruire un futuro pieno di luce. **IMPEGNO, INNOVAZIONE, SOSTENIBILITÀ, INTEGRITÀ**

The values we believe in are our trademark: they represent the foundations on which to continue building a future full of light. **COMMITMENT, INNOVATION SUSTAINABILITY, INTEGRITY**

Only through quality lighting can we see the world with different eyes. We create the best LED solutions capable of enhancing the environment and its beauties.



**CENTURY®**

Da oltre **25 anni** il tuo partner per l'illuminazione.  
Your lighting partner for over **25 years**.



    
century-italia.com



## CATALISTINO N° 10

LIGHTING 2022·2023

**LED**



**N° 1**  
Primo Catalogo LED  
2011 184 pag.

**N° 2**  
2012 150 pag.

**N° 3**  
2013 152 pag.

**N° 4**  
2014 176 pag.

**N° 5**  
2015 214 pag.

*Through the years*

**There is a light  
that never goes out.**

Let's retrace the LED era together,  
from the first catalog to the current tenth edition.

Attraverso gli anni

**C'è una luce  
che non si spegne mai.**

Ripercorriamo insieme l'era del LED,  
dal primo catalogo all'attuale decima edizione.



**N° 6**  
2017 272 pag.

**N° 7**  
2019 344 pag.

**N° 8**  
2020 384 pag.

**N° 9**  
2021 392 pag.

**N° 10**  
2022 392 pag.









PANNELLI  
PANNELLI  
**PANNELLI**  
PANNELLI  
PANNELLI

LED PANEL  
LED PANEL  
**LED PANEL**  
LED PANEL  
LED PANEL

# TECNOLOGIA

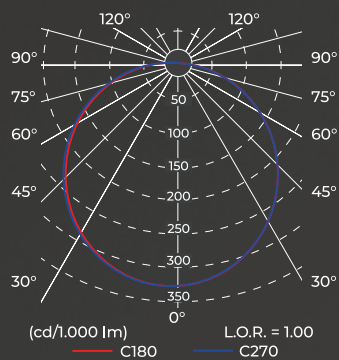
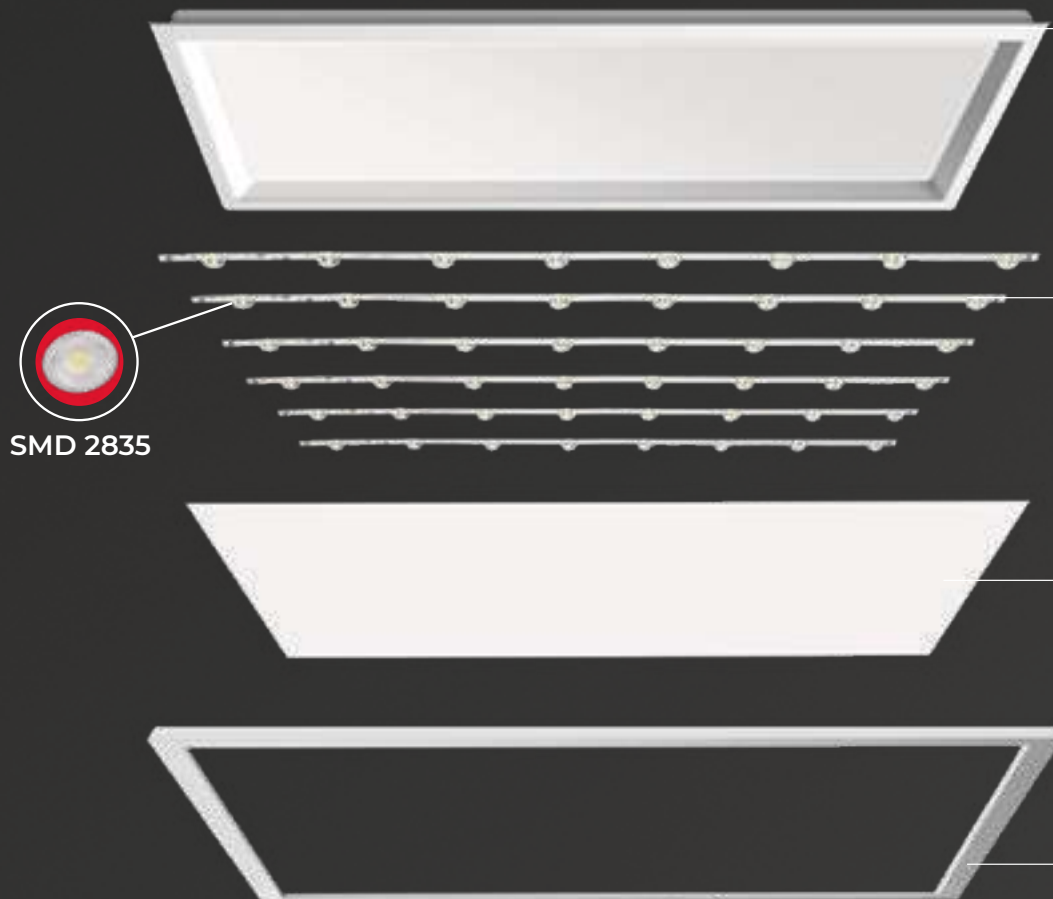

Eccellente distribuzione della luce, abbagliamento ridotto e perfetta copertura delle superfici.  
Excellent light distribution, reduced glare and perfect surface coverage.



# BACKLIGHT

## Cover superiore

Diffusione omogenea della luce ed elevata dissipazione

## Upper cover

Homogeneous light diffusion and high dissipation

## Chip LED con ottiche Wide-View

Montati su alluminio 1,3 mm

## LED chip with Wide-View optics

Mounted on 1,3 mm aluminum

## Diffusore UGR<19 in PMMA

Antiabbaglio, non ingiallisce

## UGR <19 diffuser in PMMA

Anti-glare, antiyellowing

## Design Ultraslim

Cornice in alluminio 6 mm

## Ultraslim design

6 mm aluminum frame

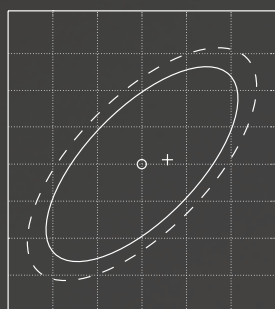

SDCM 1.7

Coerenza cromatica e omogeneità del colore.  
Chromatic coherence and color uniformity.

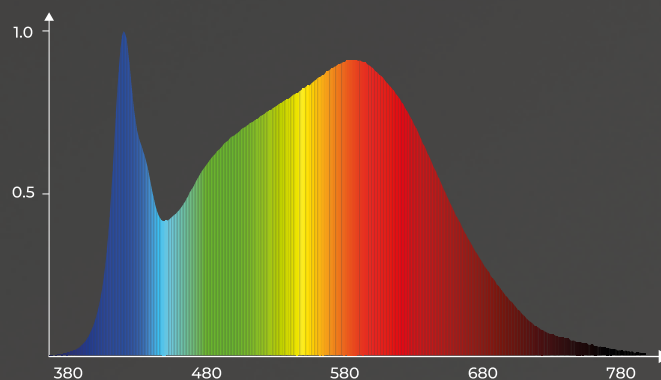

Assenza di raggi UV e IR.  
UV and IR rays free.



PANNELLI - P-QUADRO

# BACKLIGHT



MOD. PQAB90

### 30 X 120

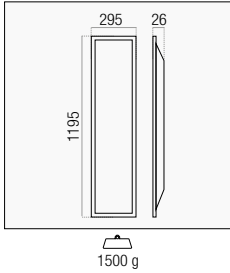

#### OUTPUT

42 W	3.600 lm	120° $\triangleleft$	220-240 V/AC 50/60 Hz	UGR < 19	4000K	<b>PQAB-421240</b>	1/4	€ 55,00
------	----------	----------------------	-----------------------	----------	-------	--------------------	-----	---------

### 60 X 60

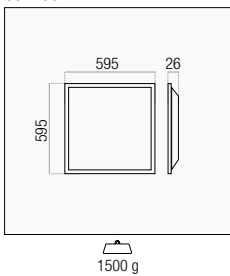

#### OUTPUT

42 W	3.600 lm	120° $\triangleleft$	220-240 V/AC 50/60 Hz	UGR < 19	4000K	<b>PQAB-426040</b>	1/4	€ 48,00
	4.100 lm	120° $\triangleleft$	220-240 V/AC 50/60 Hz	CRI > 90 - UGR < 19	4000K	<b>PQAB90-426040</b>	1/4	€ 53,00
	3.900 lm	120° $\triangleleft$	38-42 V/DC - 1000 mA C.C.*	UGR < 19 - No Driver - Diff. Prismatizzato	4000K	<b>PQABUN-426060</b>	1/4	€ 42,00

\*Constant current

6 mm

Cornice ultraslim, solo 6 mm di spessore  
Ultra slim frame, only 6 mm thickness

Pannelli da incasso a controsoffitto con tecnologia Backlight: l'impianto LED è installato sul retro del diffusore garantendo una migliore omogeneità luminosa.

Recessed ceiling panels with Backlight technology: the LED system is installed on the back of the diffuser ensuring better light uniformity.

Antingiamento - Anti-yellowing



DRIVER DIMMERABILE OPZIONALE /  
OPTIONAL DIMMABLE DRIVER

42 W	<b>DRIMPQ42</b>	1/50	€ 40,00
	<b>DRIMPQ40</b>	1/50	€ 50,00
40 W	<b>DRIMPQ42D</b>	1/100	€ 54,00

# TECHNOLOGY

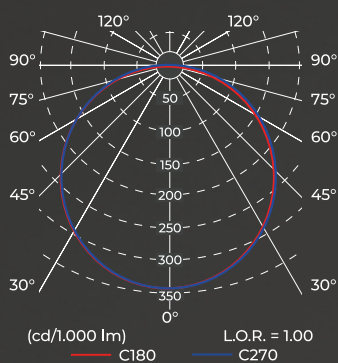

Eccellente distribuzione della luce, abbagliamento ridotto e perfetta copertura delle superfici.  
Excellent light distribution, reduced glare and perfect surface coverage.

# ADVANCE

**Cover superiore in alluminio**  
Aluminum upper cover

**Schiuma Antiurto 2 mm**  
2 mm shockproof foam

**Riflettore**  
Reflector

**Pannello di trasmissione luminosa**  
Light transmission plate

**Diffusore UGR<19 in PMMA Antingiallimento**  
PMMA UGR <19 anti-yellowing diffuser

**Chip LED SMD**

**Cornice Ultraslim**  
Ultraslim frame

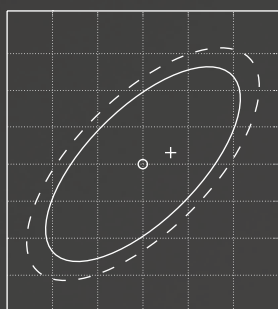

**SDCM 1.6**

Coerenza cromatica e omogeneità del colore.  
Chromatic coherence and color uniformity.

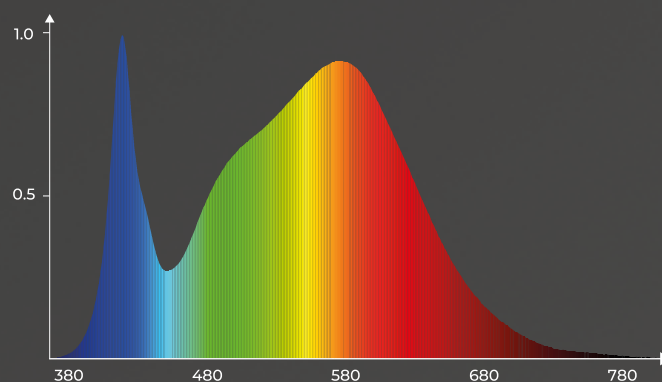

Assenza di raggi UV e IR.  
UV and IR rays free.



**NEW**

PANNELLI - P-QUADRO

# ADVANCE



PANNELLI

### 30 X 60

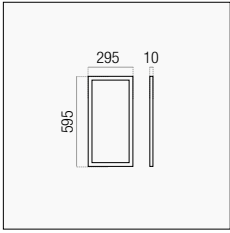

1150 g

		SOURCE		OUTPUT					
24 W	2.830 lm	1.840 lm	120° ∠	220-240 V/AC 50/60 Hz	UGR < 19	3000K	<b>PQA-243030</b>	1/6	€ 41,00
	3.000 lm	1.950 lm	120° ∠	220-240 V/AC 50/60 Hz	UGR < 19	4000K	<b>PQA-243040</b>		

### 30 X 120

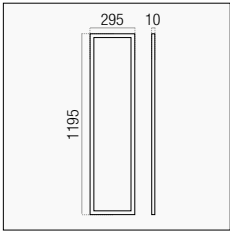

1980 g

		SOURCE		OUTPUT							
42 W	4.300 lm	3.900 lm	120° ∠	220-240 V/AC 50/60 Hz	UGR<19	3000K	<b>PQA-421230</b>	1/6	€ 65,00		
						4000K	<b>PQA-421240</b>				
					CRI>90 - UGR<19	3000K	<b>PQA90-421230</b>	1/6	€ 72,00		
						4000K	<b>PQA90-421240</b>				
					38-42 V/DC - 1000 mA C.C.*	UGR<19 - No driver		4000K	<b>PQAN-421240</b>	1/6	€ 50,00
						CRI>90 - UGR<19 - No driver		4000K	<b>PQAN90-421240</b>	1/6	€ 59,00

\*Constant current

### 60 X 60

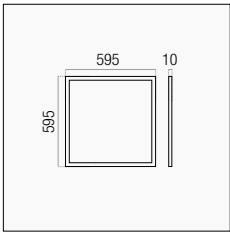

2200 g

		SOURCE		OUTPUT							
42 W	4.300 lm	3.900 lm	120° ∠	220-240 V/AC 50/60 Hz	UGR<19	3000K	<b>PQA-426030</b>	1/6	€ 55,00		
						4000K	<b>PQA-426040</b>				
					Industrial Pack - UGR<19		4000K	<b>PQAM-426040 NEW</b>	6	€ 53,00	
					UGR<19		6000K	<b>PQA-426060</b>	1/6	€ 55,00	
					CRI>90 - UGR<19	3000K	<b>PQA90-426030</b>	1/6	€ 61,00		
						4000K	<b>PQA90-426040</b>				
					38-42 V/DC - 950 mA C.C.*	UGR<19 - No driver		4000K	<b>PQAN-426040</b>	1/6	€ 43,00
						CRI>90 - UGR<19 - No driver		4000K	<b>PQAN90-426040</b>	1/6	€ 48,00

\*Constant current

### 60 X 120

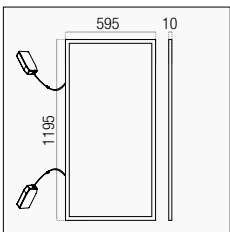

4380 g

		SOURCE		OUTPUT					
64 W	8.710 lm	7.900 lm	120° ∠	220-240 V/AC 50/60 Hz	UGR<19 - 2 Driver incl.	4000K	<b>PQA-646040</b>	1/6	€ 192,00

#### PQAM-426040 - Industrial pack 6 pz

Imballato con FOAM di protezione (solo master box)  
Packed with protective FOAM (only master box)



Pannelli dal design elegante e ultra sottili. Disponibili in diverse temperature di colore, con alimentatore incluso o opzionale. Assenza di raggi UV e IR, antisfarfallio.

Ultra thin panels with elegant design. Available in different color temperatures, included or optional power supply. UV and IR rays, flicker-free.



Antingiallimento - Anti-yellowing

Recessed Front

#### RICAMBIO DRIVER / SPARE DRIVER

24 W	<b>RDPQA24</b>	1/100	€ 17,00
42 W	<b>RDPQA42</b>	1/100	€ 30,00
64 W	<b>RDPQA64</b>	1/50	€ 23,00

#### DRIVER DIMMERABILE OPZIONALE / OPTIONAL DIMMABLE DRIVER

42 W	<b>DRIMPQ42</b>	1/50	€ 40,00
	<b>DRIMPQ40</b>	1/50	€ 50,00
40 W	<b>DRIMPQ42D</b>	1/100	€ 54,00



**CENTURY**

# IP65

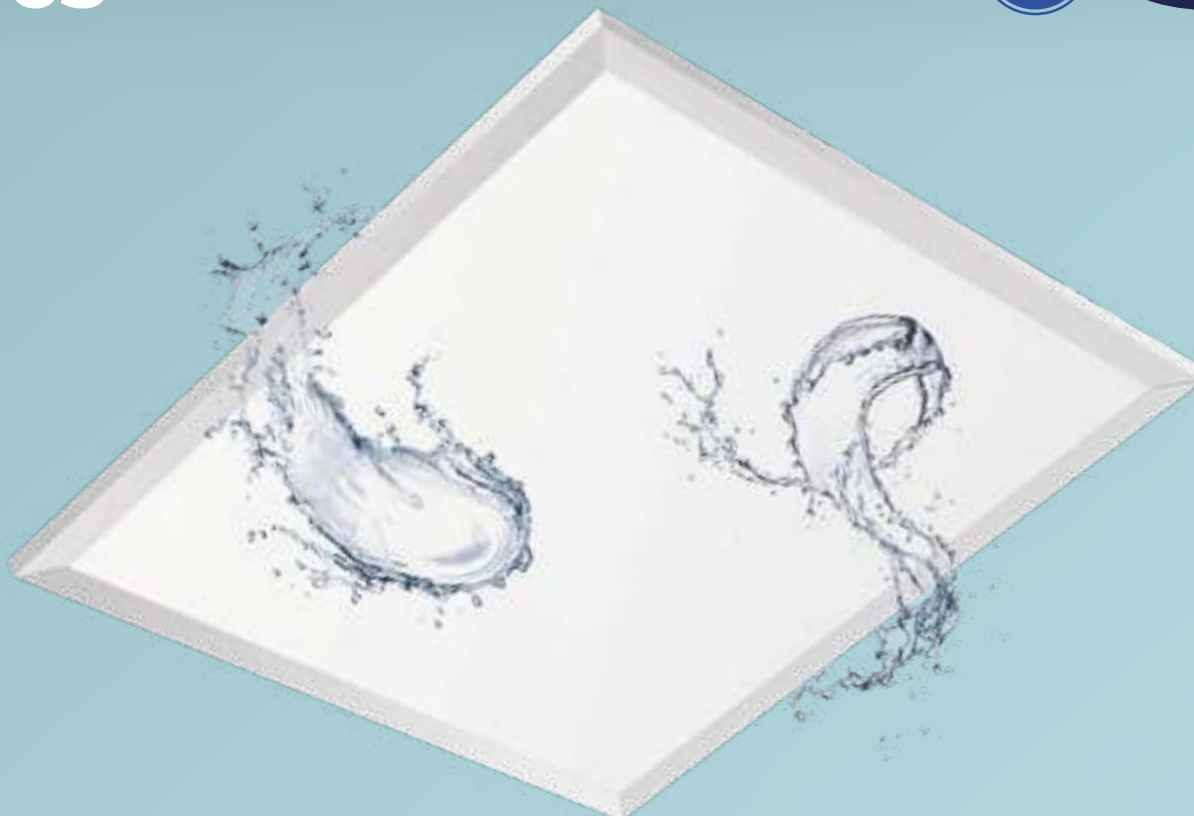

Ideale per ambienti medici, umidi o molto polverosi  
Suitable for hospitals and humid/dusty environments

60 X 60

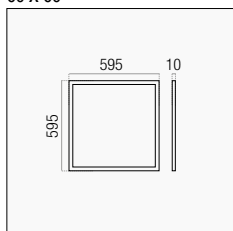

2750 g

OUTPUT

40 W	4.370 lm	120° ∠	220-240 V/AC 50/60 Hz	IP65 - Flicker Free	4000K	<b>PQA65-406040</b>	1/6	€ 156,00
------	----------	--------	-----------------------	---------------------	-------	---------------------	-----	----------

Pannello IP65 completamente protetto da polveri e liquidi. Driver e connettori IP65 inclusi. Struttura in alluminio robusto dall'elevata resistenza.

IP65 panel fully protected from dust and liquids. IP65 drivers and connectors included. Sturdy aluminum structure with high resistance.

Antingiamento - Anti-yellowing



Protezione totale da polvere e acqua  
Total protection from dust and water



PANNELLI - P-QUADRO 42U ADVANCE

# PRISMATIZZATO



Schermo prismatico antiabbagliamento  
Anti-glare prismatic diffuser

60 X 60

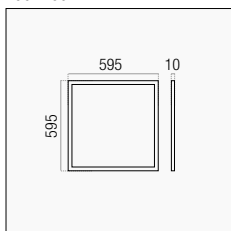

3000 g

OUTPUT

42 W	3.950 lm	120° ∠	220-240 V/AC 50/60 Hz	Diff. Prismatico - UGR<19	4000K	<b>PQ42U-426040</b>	1/6	€ 74,00
------	----------	--------	-----------------------	---------------------------	-------	---------------------	-----	---------

Diffusore prismatico UGR<19  
UGR < 19 prismatic diffuser

Installabile direttamente in controsoffitti a pannelli di cartongesso o a sospensione. Driver LIFUD incluso antisfarfallio.

Plasterboard or suspended ceilings installation. Flicker-free LIFUD driver included.

Antingiamento - Anti-yellowing



DRIVER DIMMERABILE OPZIONALE /  
OPTIONAL DIMMABLE DRIVER

42 W	<b>DRIMPQ42</b>	1/50	€ 40,00
	<b>DRIMPQ40</b>	1/50	€ 50,00
40 W	<b>DRIMPQ42D</b>	1/100	€ 54,00

# P-LINE 40

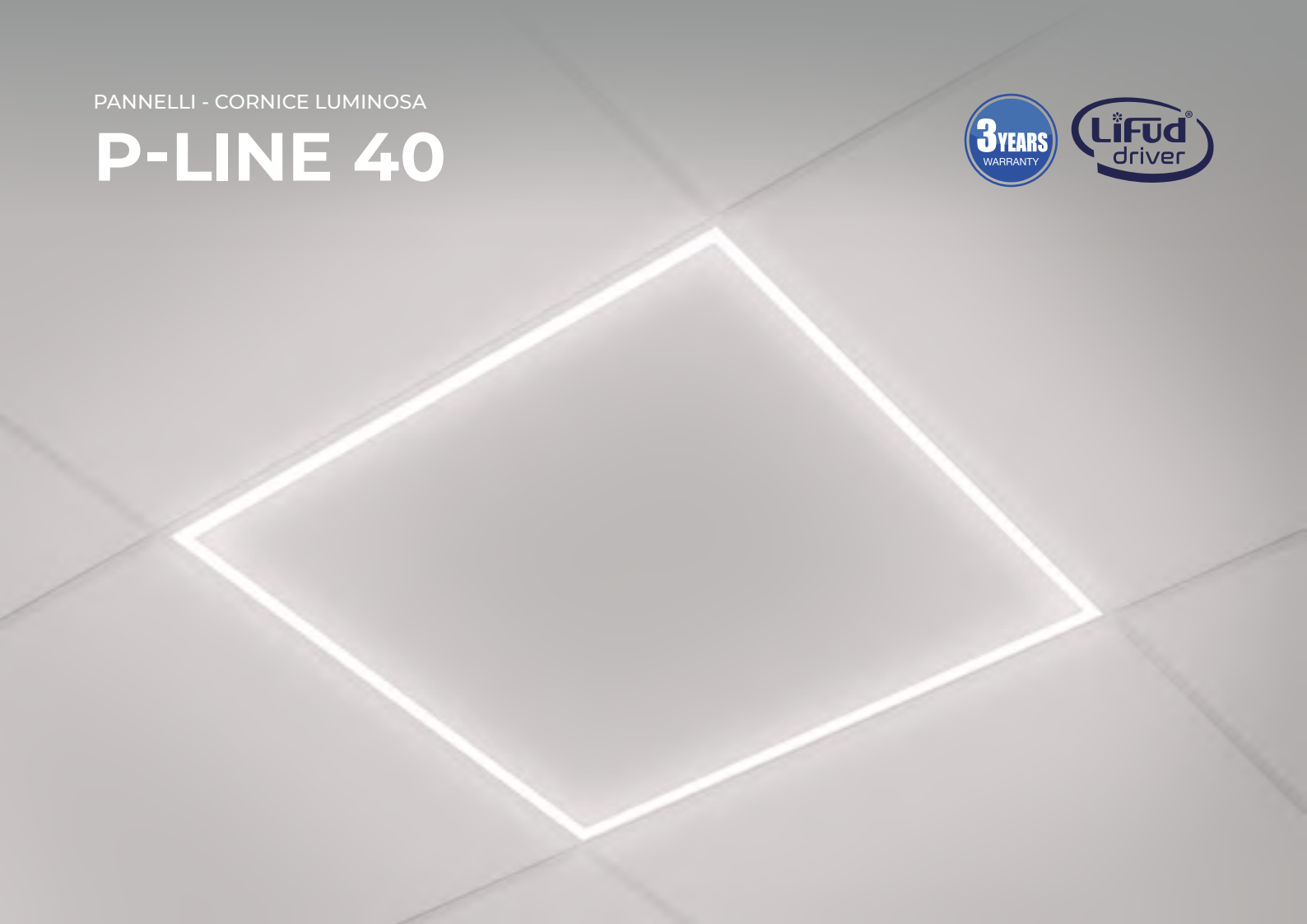

60 X 60

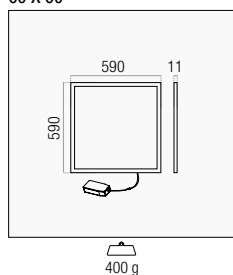

SOURCE		OUTPUT							
36 W	4,500 lm	3,500 lm	120° ∠	220-240 V/AC 50/60 Hz	Filo luce - Driver LIFUD	4000K	<b>PL-406040</b>	1/10	€ 53,00

Cavo da 1,5 metri incluso  
1.5 meter cable included



Fissaggio a incasso o a sospensione con accessori  
Recessed or suspended fixing with accessories

<b>KIT-PLINE</b>	1/100	€ 8,00
------------------	-------	--------

Cornice luminosa filoluce con 10 mm di spessore. Fissaggio a incasso e a sospensione tramite kit opzionale. Driver LIFUD incluso.

Light frame with 10 mm thickness. Recessed and suspended fixing with optional kit. LIFUD driver included.



DRIVER DIMMERABILE OPZIONALE /  
OPTIONAL DIMMABLE DRIVER

42 W	<b>DRIMPQ42</b>	1/50	€ 40,00
	<b>DRIMPQ40</b>	1/50	€ 50,00
40 W	<b>DRIMPQ42D</b>	1/100	€ 54,00

PANNELLI

# FALSO MODULO



Idoneo per lucernai  
Suitable for skylights

60 X 60

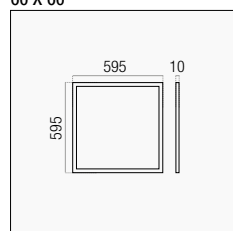

640 g

PQAFM-6060

1/6

€ 20,00

Sistema d'illuminazione passivo che cattura la luce ambientale/solare sovrastante. Diffonde in maniera ottimale la luce naturale e permette di risparmiare sui costi energetici.

Passive lighting system throughout ambient / solar light above. It natural light diffuser for energy saving cost.

IP20

**Pannello Skyline / Skyline panel**

Pannello ideale per lucernai.  
Diffonde la luce naturale.

Suitable for skylights.  
Natural light diffusion.



# RECESSED



## 62 X 62

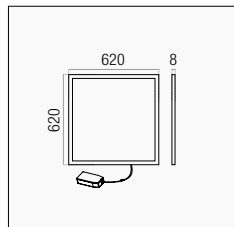

600 x 600 mm 1-20 mm 1750 g

### OUTPUT

40 W	3.700 lm	120° ∠	230 V/AC 50/60 Hz	Driver incluso - Cornice sottile	3000K	<b>PQR-406230</b>	1/6	€ 61,00
					4000K	<b>PQR-406240</b>		

## 60 X 10

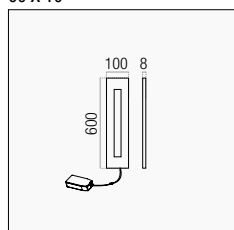

80 x 580 mm 1-20 mm 350 g

### OUTPUT

18 W	700 lm	120° ∠	230 V/AC 50/60 Hz	Driver incluso - Cornice sottile	3000K	<b>PRL-186030</b>	1/10	€ 36,00
					4000K	<b>PRL-186040</b>		

## 120 X 10

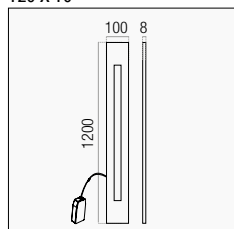

80 x 1180 mm 1-20 mm 743 g

### OUTPUT

36 W	1.476 lm	120° ∠	230 V/AC 50/60 Hz	Driver incluso - Cornice sottile	3000K	<b>PRL-361230</b>	1/10	€ 53,00
					4000K	<b>PRL-361240</b>		

Specifico per installazioni a filo controsoffitto  
Specific for false ceiling installations

Cornice invisibile, solo 1 mm di spessore  
Invisible frame, only 1 mm thick

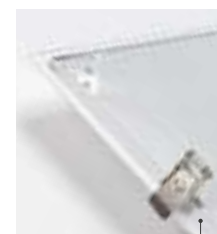

Clip per installazione a scomparsa incluse  
Clips for concealed installation included

Pannello LED con design innovativo e effetto a scomparsa, per applicazioni in cartongesso. Cornice ultrasottile di solo 1 mm di spessore. Alimentatore esterno in dotazione, privo di raggi UV e IR.

LED panel with innovative design and concealed effect, for plasterboard applications. Ultra-thin frame only 1mm thick. External power supply included. UV and IR rays free.

Antingiamento - Anti-yellowing



DRIVER DIMMERABILE OPZIONALE /  
OPTIONAL DIMMABLE DRIVER

42 W	<b>DRIMPQ42</b>	1/50	€ 40,00
	<b>DRIMPQ40</b>	1/50	€ 50,00
40 W	<b>DRIMPQ42D</b>	1/100	€ 54,00

# TECHNOLOGY

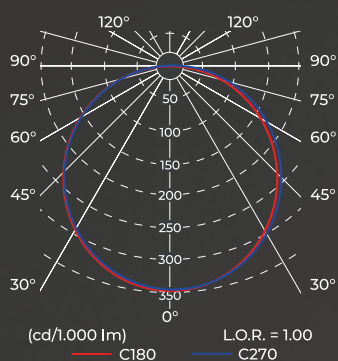

Eccellente distribuzione della luce, abbagliamento ridotto e perfetta copertura delle superfici.  
Excellent light distribution, reduced glare and perfect surface coverage.



# P-TONDO / P-QUADRO

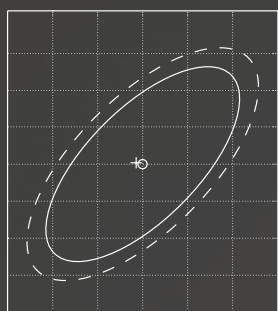
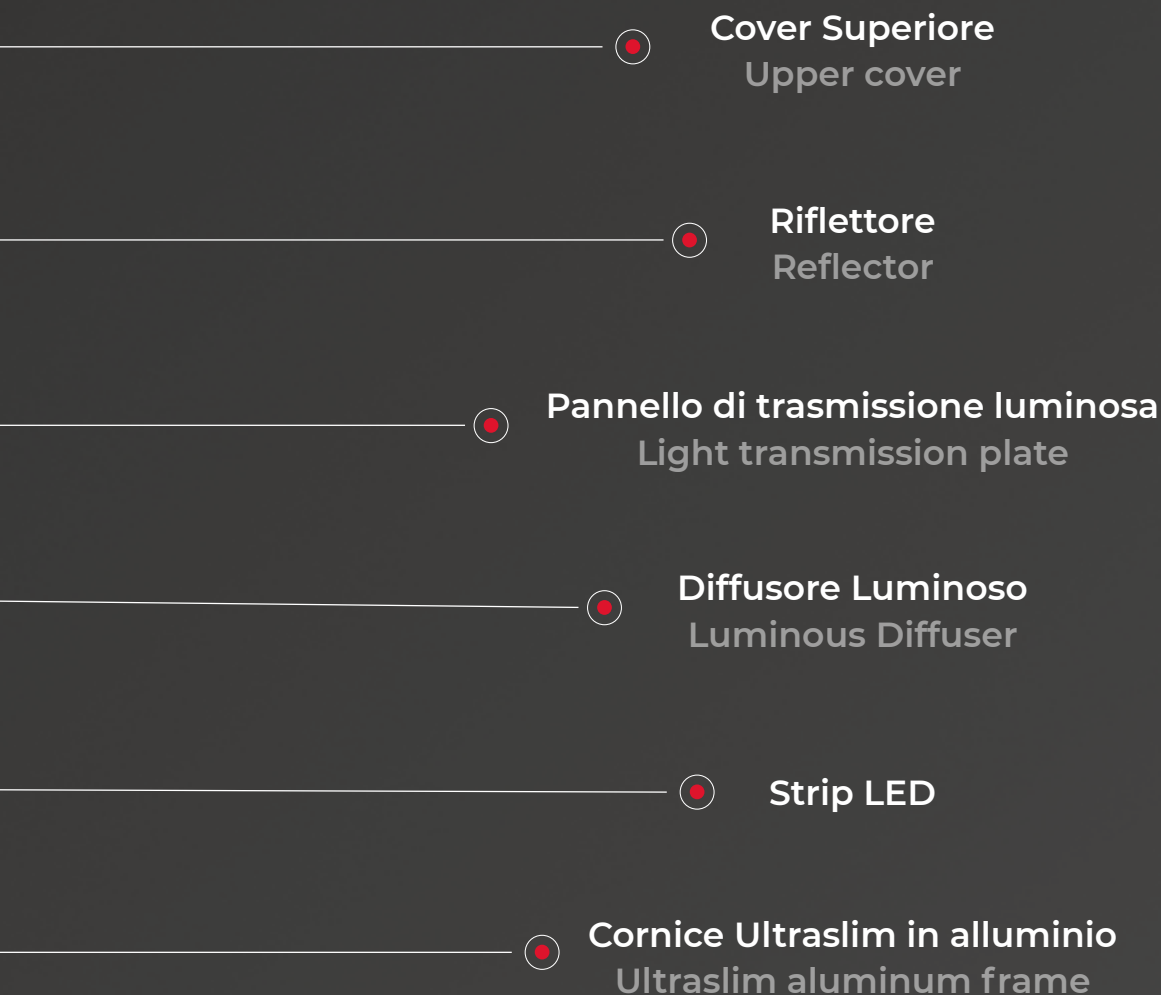

**SDCM 0.5**

Coerenza cromatica e omogeneità del colore.  
Chromatic coherence and color homogeneity.

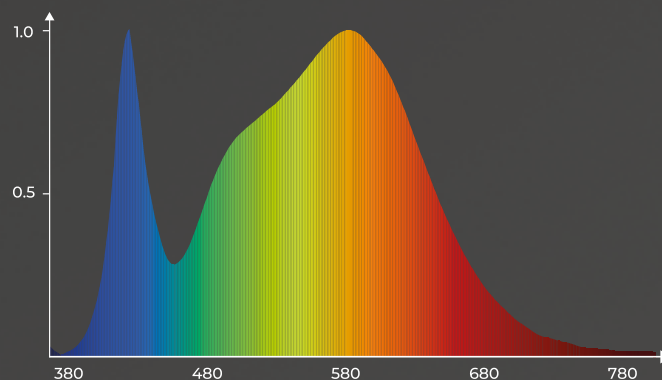

Assenza di raggi UV e IR.  
Absence of UV and IR rays.



PANNELLI - INCASSO

# P-TONDO / P-QUADRO

## P-TONDO

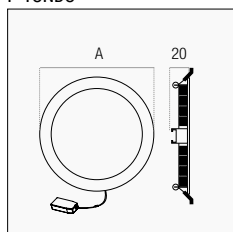

1-12 mm

	A mm	mm	g
3 W	Ø85	Ø70	138
6 W	Ø117	Ø105	188
9 W	Ø147	Ø130	181
12 W	Ø170	Ø155	236
18 W	Ø225	Ø205	373
24 W	Ø300	Ø280	532

	SOURCE		OUTPUT						
3 W	260 lm	180 lm	120° ∠	220-240 V/AC 50/60 Hz	Driver Incluso	3000K	<b>PT-038530</b>	6/24	€ 9,00
						4000K	<b>PT-038540</b>		
6 W	550 lm	400 lm	120° ∠	220-240 V/AC 50/60 Hz	Driver Incluso	3000K	<b>PT-061230</b>	6/24	€ 12,00
						4000K	<b>PT-061240</b>		
9 W	780 lm	600 lm	120° ∠	220-240 V/AC 50/60 Hz	Driver Incluso	3000K	<b>PT-091430</b>	6/24	€ 15,00
						4000K	<b>PT-091440</b>		
12 W	1.100 lm	960 lm	120° ∠	220-240 V/AC 50/60 Hz	Driver Incluso	3000K	<b>PT-121730</b>	6/24	€ 17,00
						4000K	<b>PT-121740</b>		
18 W	1.800 lm	1.440 lm	120° ∠	220-240 V/AC 50/60 Hz	Driver Incluso	3000K	<b>PT-182230</b>	6/24	€ 21,00
						4000K	<b>PT-182240</b>		
24 W	2.350 lm	1.920 lm	120° ∠	220-240 V/AC 50/60 Hz	Driver Incluso	3000K	<b>PT-243030</b>	6/12	€ 30,00
						4000K	<b>PT-243040</b>		

## P-QUADRO

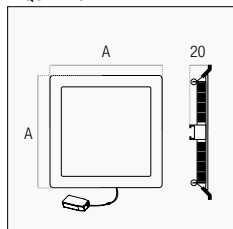

1-12 mm

	A mm	mm	g
3 W	85	65x65	112
6 W	120	100x100	157
9 W	145	130x130	244
12 W	172	155x155	280
18 W	225	205x205	455
24 W	300	280x280	550

	SOURCE		OUTPUT						
3 W	260 lm	180 lm	120° ∠	220-240 V/AC 50/60 Hz	Driver Incluso	3000K	<b>PQ-038530</b>	6/24	€ 11,00
						4000K	<b>PQ-038540</b>		
6 W	550 lm	400 lm	120° ∠	220-240 V/AC 50/60 Hz	Driver Incluso	3000K	<b>PQ-061230</b>	6/24	€ 13,00
						4000K	<b>PQ-061240</b>		
9 W	780 lm	600 lm	120° ∠	220-240 V/AC 50/60 Hz	Driver Incluso	3000K	<b>PQ-091430</b>	6/24	€ 16,00
						4000K	<b>PQ-091440</b>		
12 W	1.100 lm	960 lm	120° ∠	220-240 V/AC 50/60 Hz	Driver Incluso	3000K	<b>PQ-121730</b>	6/24	€ 18,00
						4000K	<b>PQ-121740</b>		
18 W	1.800 lm	1.440 lm	120° ∠	220-240 V/AC 50/60 Hz	Driver Incluso	3000K	<b>PQ-182230</b>	6/24	€ 23,00
						4000K	<b>PQ-182240</b>		
24 W	2.350 lm	1.920 lm	120° ∠	220-240 V/AC 50/60 Hz	Driver Incluso	3000K	<b>PQ-243030</b>	6/12	€ 32,00
						4000K	<b>PQ-243040</b>		

Ottica antiabbaglio, alimentatore esterno in dotazione, assenza di raggi UV e IR.  
Design elegante ultrasottile.

Anti-glare optics, external power supply included, UV and IR rays free.  
Ultra-thin elegant design.



### RICAMBIO DRIVER / SPARE DRIVER

12 W	<b>RDPQ12</b>	1/50	€ 11,00
18 W	<b>RDPQ18</b>	1/100	€ 11,00
24 W	<b>RDPQ24</b>	1/100	€ 13,00

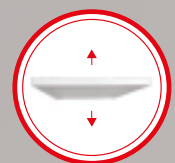

SUPER SLIM

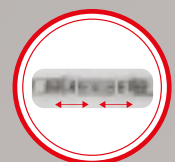

MOLLE REGOLABILI  
ADJUSTABLE SPRINGS



FISSAGGIO A PLAFONE  
CEILING FIXING

PANNELLI - INCASSO / PLAFONE

## FRISBEE

## FRISBEE QUADRO

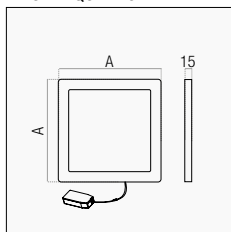

1-12 mm

	A mm	mm	g
12 W	180	65 – 155	335
18 W	230	65 – 205	504

## OUTPUT

12 W	960 lm	120° ∠	220-240 V/AC 50/60 Hz	Driver Incluso	3000K	<b>FRBS-121830</b>	1/20	€ 32,00
					4000K	<b>FRBS-121840</b>		
18 W	1.440 lm	120° ∠	100-240 V/AC 50/60 Hz	Driver Incluso	3000K	<b>FRBS-182330</b>	1/20	€ 37,00
					4000K	<b>FRBS-182340</b>		

Doppia modalità di installazione: plafone o incasso  
 Double installation method: ceiling or recessed

## FRISBEE TONDO

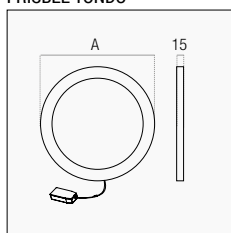

1-12 mm

	A mm	mm	g
12 W	Ø180	Ø65 – Ø155	216
18 W	Ø230	Ø65 – Ø205	346

## OUTPUT

12 W	960 lm	120° ∠	220-240 V/AC 50/60 Hz	Driver Incluso	3000K	<b>FRB-121830</b>	1/20	€ 32,00
					4000K	<b>FRB-121840</b>		
18 W	1.440 lm	120° ∠	220-240 V/AC 50/60 Hz	Driver Incluso	3000K	<b>FRB-182330</b>	1/20	€ 37,00
					4000K	<b>FRB-182340</b>		

Doppia modalità di installazione: plafone o incasso  
 Double installation method: ceiling or recessed

## 1. Incasso / Recessed

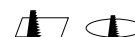

Da 65 fino a 155 (12 W) o 205 (18 W) mm  
 From 65 up to 155 (12 W) or 205 (18 W) mm



Fissaggio a incasso in tramite molle regolabili  
 Recessed mounting with adjustable springs

## 2. Plafone / Ceiling



facile installazione  
 ruotare per sbloccare la staffa

Facile installazione a plafone tramite staffa  
 Easy ceiling installation with bracket

Duplice soluzione di fissaggio a incasso e plafone, design elegante e compatto, solo 15 mm di spessore. (Driver integrato antisfarfallio)

Dual recessed and ceiling mounting solution, elegant and compact design, only 15 mm thickness. (Flicker-free driver included)



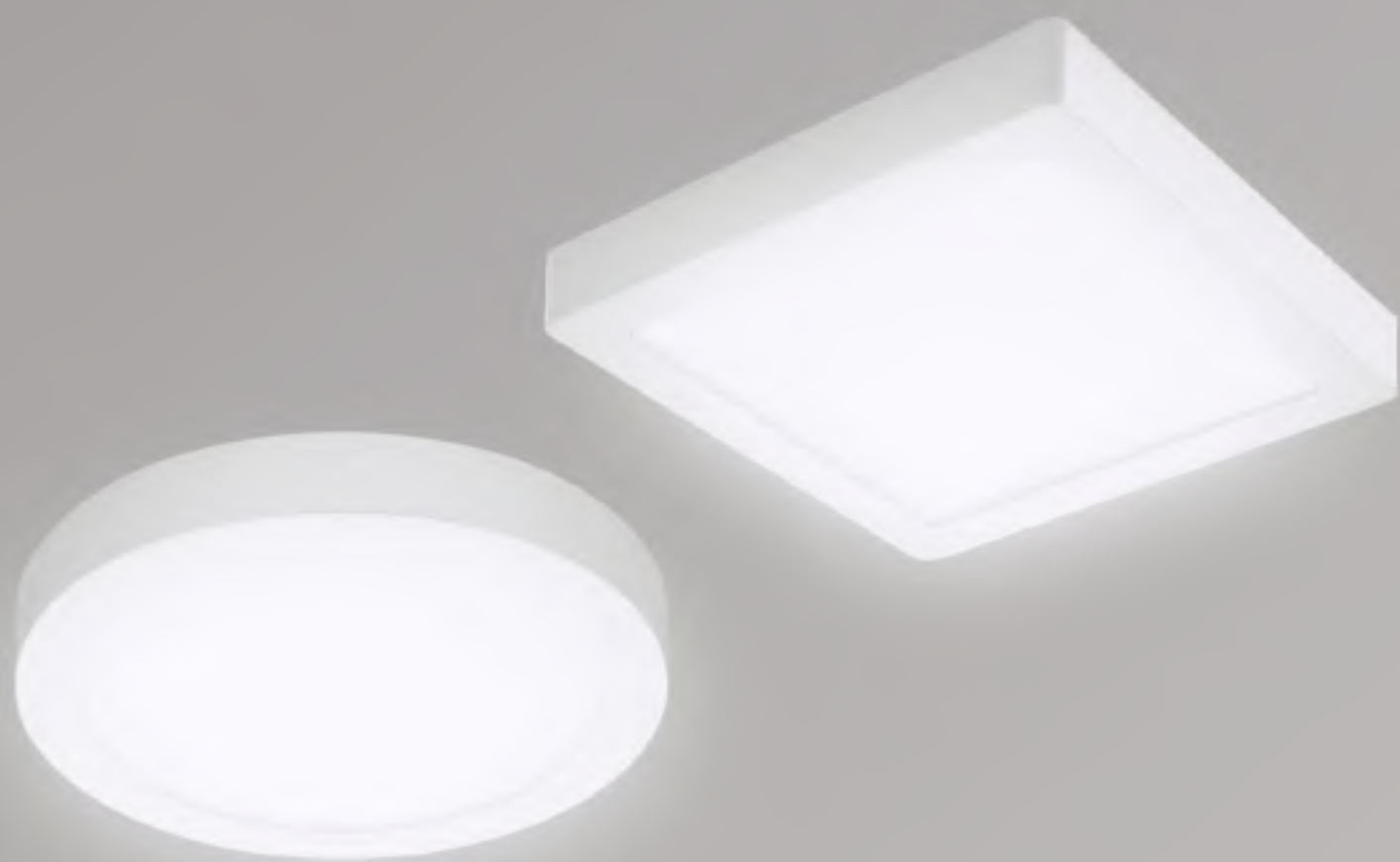









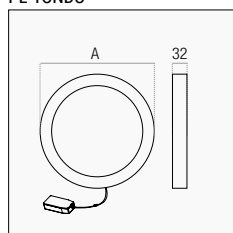



PANNELLI - PLAFONE

# PL-TONDO / PL-QUADRO

## PL-TONDO









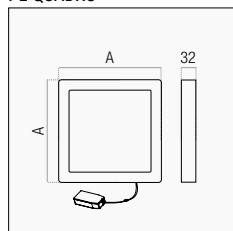

	A mm	 g
18 W	Ø220	408
24 W	Ø300	850

		SOURCE		OUTPUT					
18 W	1.800 lm	1.440 lm	120° 	220-240 V/AC 50/60 Hz	Driver Incluso - Alluminio	3000K 	<b>PTP-182230</b>	6/24 	€ 30,00
						4000K 	<b>PTP-182240</b>		
24 W	2.350 lm	1.920 lm	120° 	220-240 V/AC 50/60 Hz	Driver Incluso - Alluminio	3000K 	<b>PTP-243030</b>	6/12 	€ 35,00
						4000K 	<b>PTP-243040</b>		

## PL-QUADRO



	A mm	 g
18 W	225	519
24 W	300	827



		SOURCE		OUTPUT					
18 W	1.800 lm	1.440 lm	120° 	220-240 V/AC 50/60 Hz	Driver Incluso - Alluminio	3000K 	<b>PQP-182230</b>	6/24 	€ 30,00
						4000K 	<b>PQP-182240</b>		
24 W	2.350 lm	1.920 lm	120° 	220-240 V/AC 50/60 Hz	Driver Incluso - Alluminio	3000K 	<b>PQP-243030</b>	6/12 	€ 35,00
						4000K 	<b>PQP-243040</b>		

Corpo in alluminio bianco, design compatto ed elegante. Alimentatore incluso.

White aluminum body, compact and elegant design. Power supply included.



### RICAMBIO DRIVER / SPARE DRIVER

18 W	<b>RDPQ18</b>	1/100 	€ 11,00
24 W	<b>RDPQ24</b>	1/100 	€ 13,00

# XL



PL-TONDO XL

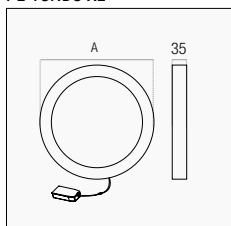

	A mm	 g
36 W	Ø500	2800
48 W	Ø600	3360

OUTPUT

36 W	3.060 lm	120°	100-240 V/AC 50/60 Hz	Driver Incluso	4000K	<b>PTP-365040</b>	1/5	€ 108,00
48 W	4.320 lm	120°	100-240 V/AC 50/60 Hz	Driver Incluso	4000K	<b>PTP-486040</b>	1/5	€ 132,00

Pannelli circolari con montaggio a plafone dal design elegante. Alimentatore incluso.

Circular ceiling-mounted panels with an elegant design. Power supply included.



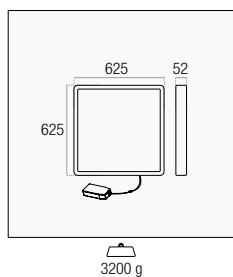

OUTPUT								
47 W	4.000 lm	120° ∠	220-240 V/AC 50/60 Hz	Driver incluso	4000K	<b>PQPLF-476240</b>	1/4	€ 84,00

Pannello installabile a soffitto con alimentatore incluso. Assenza raggi UV e IR, antiabbaglio e antisfarfallio.

Ceiling mountable panel with power supply included. UV and IR rays free, anti-glare and flicker-free.





# FRAME



PANEL 60 x 60

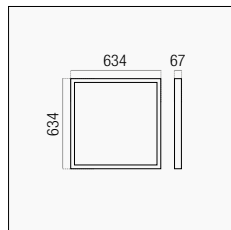

2200 g

IN	OUT			
Bianco / White ○	Nero / Black ●	<b>KIT-PLFSN</b>	1/5	€ 89,00
	Bianco / White ○	<b>KIT-PLFSB</b>		

Compatibile con / Compatible with  
**PQA-426030 / PQA-426040 / PQA-426060 / PQA90-426030**  
**PQA90-426040 / PQAN-426040 / PQ42U-426040**

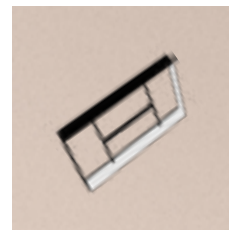

PANEL 30 x 120

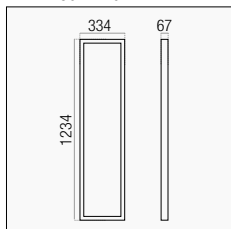

2405 g

IN	OUT			
Bianco / White ○	Nero / Black ●	<b>KIT-PLFS120N</b>	1/5	€ 98,00
	Bianco / White ○	<b>KIT-PLFS120B</b>		

Compatibile con / Compatible with  
**PQA-421230 / PQA-421240**



PANEL 60 x 120

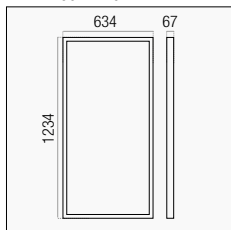

3054 g

IN	OUT			
Bianco / White ○	Nero / Black ●	<b>KIT-PLFS60120N</b>	1/5	€ 166,00
	Bianco / White ○	<b>KIT-PLFS60120B</b>		

Compatibile con / Compatible with  
**PQA-646040**

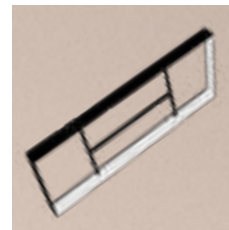

**Il pannello LED diventa una plafoniera di design**  
**The LED panel becomes a stylish ceiling light**

Elegante cornice in alluminio, ideale per trasformare un pannello LED in una plafoniera di design. Pannello LED non incluso.

Elegant aluminum frame, able to transform a LED panel in a stylish ceiling light. LED panel not included.

IP20

Elegante cornice in alluminio con finitura bianca o nera. Elegant aluminum frame with white or black finish.



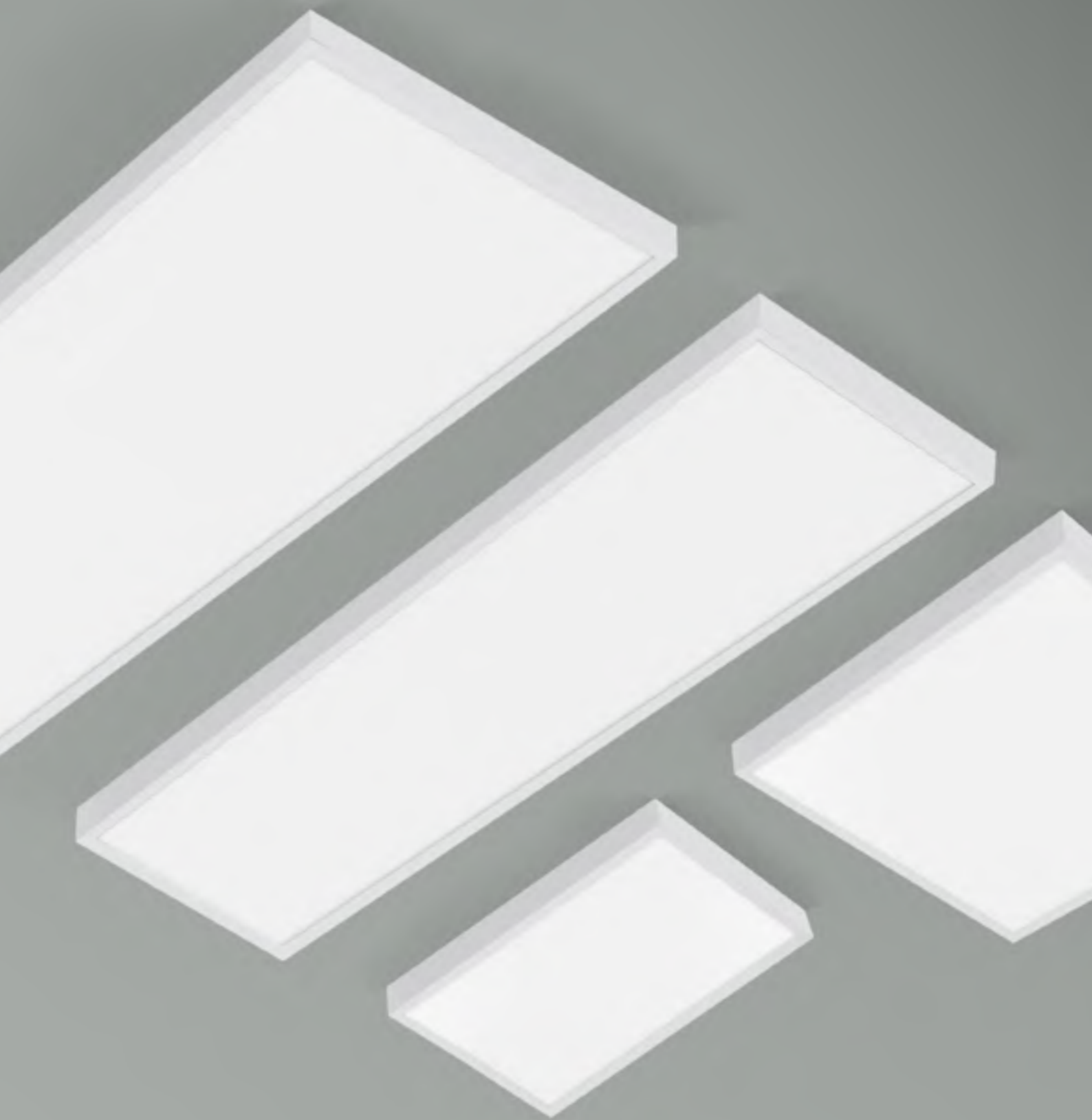



**NEW**

PANNELLI - ACCESSORI

# KIT PLAFONE

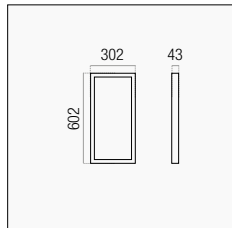
**30 x 60**

375 g

COMPATIBILITY

Bianco / White ○	Advance	<b>KIT-PLF3060 NEW</b>	1/20	€ 19,00
------------------	---------	------------------------	------	---------

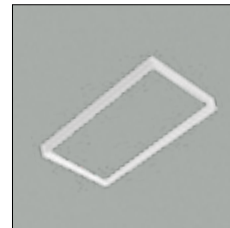
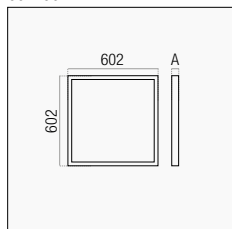
**60 x 60**

A COMPATIBILITY

Bianco / White ○	43	480	Advance	<b>KIT-PLF</b>	1/24	€ 26,00
	70	778	Backlight	<b>KIT-PLFB</b>	1/20	€ 29,00

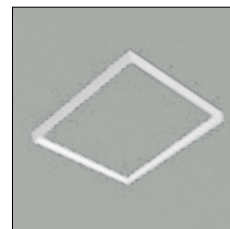
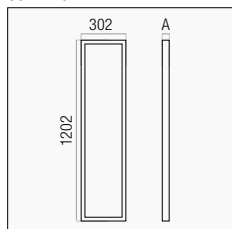
**30 x 120**

A COMPATIBILITY

Bianco / White ○	43	650	Advance	<b>KIT-PLF120</b>	1/24	€ 29,00
	70	1015	Backlight	<b>KIT-PLFB120 NEW</b>	1/20	€ 37,00

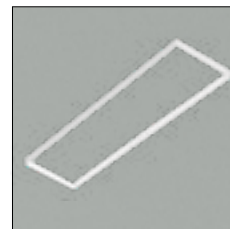
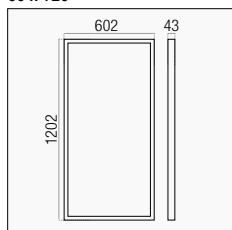
**60 x 120**

COMPATIBILITY

Bianco / White ○	Advance	<b>KIT-PLF12060</b>	1/12	€ 32,00
------------------	---------	---------------------	------	---------

730 g

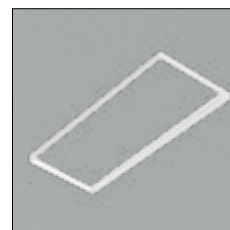
**Montaggio facilitato ad innesto rapido / Easy mounting with quick connection**

Cornice in alluminio con finitura bianca, ideale per trasformare pannelli LED in plafoniere. Pannello LED non incluso.  
Aluminum frame with white finish, able to transform LED panels into ceiling lights. LED panel not included.

# TECHNOLOGY

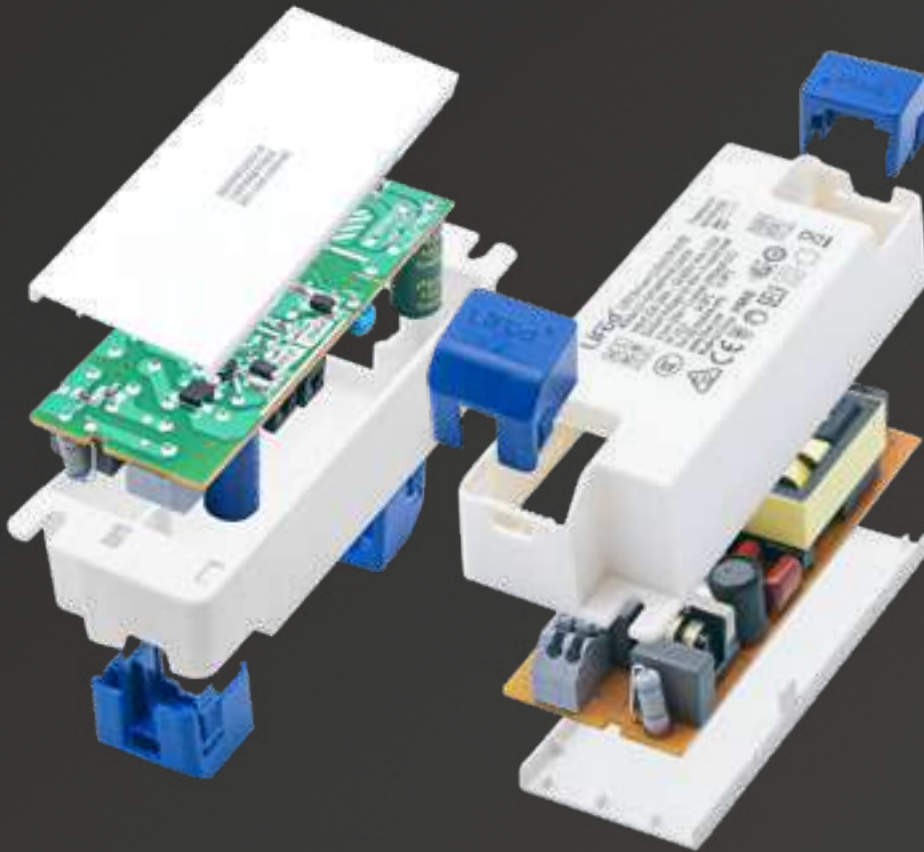

Antisfarfallio  
Flicker Free



Per pannelli ad alta luminosità  
For high brightness panels



Lunga durata  
Long life



Garanzia  
Warranty

Product life curve

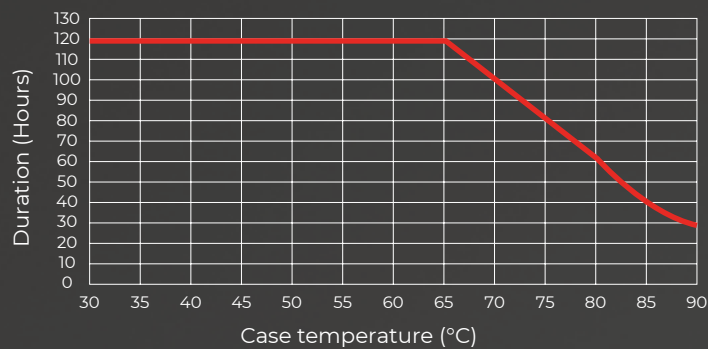

Alimentatore antisfarfallio ad altissima affidabilità.  
Highly reliable anti-flicker power supply.

**NEW**

PANNELLI - ACCESSORI

# DRIVER

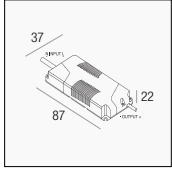

55 g

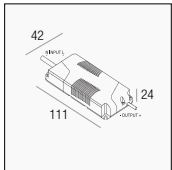

79 g

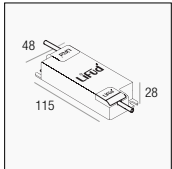

117 g

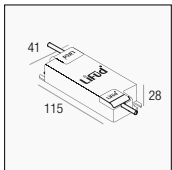

119 g

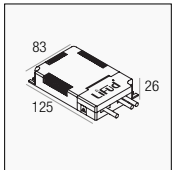

215 g

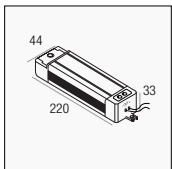

274 g

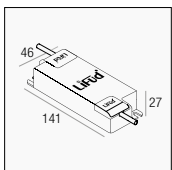

150 g

INPUT		OUTPUT					
12 W	300 mA ± 5%	220-240 V/AC 50/60 Hz	38 V/DC	No Dimm.	<b>RDPQ12</b>	1/50	€ 11,00

INPUT		OUTPUT					
18 W	300 mA	220-240 V/AC 50/60 Hz	54 V/DC	No Dimm.	<b>RDPQ18</b>	1/100	€ 11,00
24 W	600 mA ± 5%	220-240 V/AC 50/60 Hz	36 V/DC	No Dimm.	<b>RDPQ24</b>	1/100	€ 13,00
			24-42 V/DC	No Dimm.	<b>RDPQA24</b>	1/100	€ 17,00

INPUT		OUTPUT					
42 W	950 mA ± 5%	100-240 V/AC 50/60 Hz	30-40 V/DC	No Dimm.	<b>RDPQA42</b>	1/100	€ 30,00
	1000 mA	220-240 V/AC 50/60 Hz	25-42 V/DC	No Dimm.	<b>RDPQA42120</b>	1/100	€ 22,00



INPUT		OUTPUT					
64 W	850 mA ± 5%	220-240 V/AC MAX 0.35 A	33-40 V/DC	No Dimm.	<b>RDPQA64</b>	1/50	€ 23,00



DIMMERABILE 1-10V		INPUT		OUTPUT				
42 W	850-1050 mA (CC)	220-240 V/AC 50/60 Hz MAX 0.3 A	25-40 V/DC	1-10 V	<b>DRIMPQ42</b>	1/50	€ 40,00	



DIMMERABILE TRAILING EDGE		INPUT		OUTPUT				
42 W	1050 mA ± 5%	170-265 V/AC 50/60 Hz	30-44 V/DC	10%-100%	<b>DRIMPQ40</b>	1/50	€ 50,00	



DIMMERABILE DALI		INPUT		OUTPUT				
40 W	550-1050 mA	220-240 V/AC MAX 0.3 A	20-42 V/DC	DALI 2 - PUSH DIM	<b>DRIMPQ42D NEW</b>	1/100	€ 54,00	



Funzione multicorrente 550-1050 mA per alimentare diverse tipologie di apparecchi LED.  
550-1050 mA multi-current function for different types of LED luminaires.



# INSTALLAZIONE

## KIT SOSPENSIONE

Kit composto da cavi lunghi 100 cm e viti in acciaio inox. Peso 65 g  
100 cm long cables kit with stainless steel screws. Weight 65 g

COD.	COMPATIBILITY		
<b>KIT-PQ40</b>	<b>PQ42U 42 W - PQA 24 W / 42 W / 80 W</b>	1/100	€ 11,00
<b>KIT-PLINE</b>	<b>PL-406040 40 W</b>	1/100	€ 8,00



## KIT CLIP

Clip di fissaggio in acciaio per installazioni su cartongesso. Peso 80 g.  
Steel fixing clip for plasterboard installation. Weight 80 g.

COD.	COMPATIBILITY		
<b>KIT-CLIP</b>	<b>PQ42U 42 W - PQA 24 W / 42 W</b>	1/100	€ 11,00

# EMERGENZA

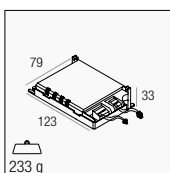

EMERG.	INPUT	OUTPUT		RICARICA / RECHARGE
2 h / MAX 3 W	110-240 V/AC 50/60 Hz	12-80 V/DC 50 mA	Ni-CD 7.2 V/DC 1.000 mAh	24 h <b>KIT-EMG2</b> 1/48  € 50,00



Utilizzabile su qualsiasi apparecchio con **driver** separato. Compreso di **indicatore LED** e **Test Switch**.  
Can be used on any device with separate **driver**. **LED indicator** and **Test Switch** included.

Compatibile con / Compatible with:

FUTURA ADVANCE FTA da 8W a 32W  
FUTURA PRO FTP 10W / 15W / 20W / 28W / 35W  
ZENO ZNS 10W / 16W / 32W - ZNR 10W / 16W / 32W  
P-QUADRO / P-TONDO PT e PQ da 12 a 24W / PQP e PTP 18W e 24W  
(compatibilità elettronica e non meccanica)  
P-LINE 40 PL 40W  
P-QUADRO 42U  
P-QUADRO ADVANCE PQA 24W / 42W / 80W - KIT-PQA 40W - PQAN 40W - PQAM

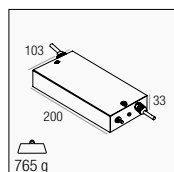
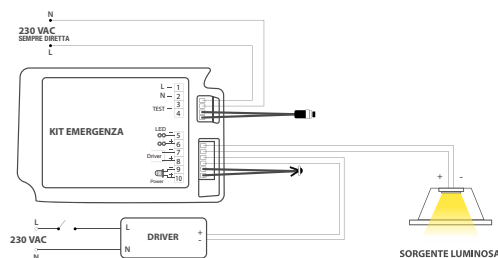

EMERG.	INPUT	OUTPUT		RICARICA / RECHARGE
3 h / 3-5 W	110-265 V/AC 50/60 Hz	12-60 V/DC 100 mA	Ni-CD 6 V/DC 3.000 mAh	24 h <b>KIT-EMG</b> 1/18  € 77,00



Utilizzabile su qualsiasi apparecchio con **driver** separato. Compreso di **indicatore LED** e **Test Switch**.  
Can be used on any device with separate **driver**. Including **LED indicator** and **Test Switch** included.

Compatibile con / Compatible with:

FUTURA ADVANCE FTA da 8W a 32W  
FUTURA SHOP 95 FTS da 30W/60W  
P-QUADRO 42U  
P-QUADRO ADVANCE PQA 24W / 42W / 80W - KIT-PQA 40W - PQAN 40W - PQAM  
P-LINE 40 PL 40W

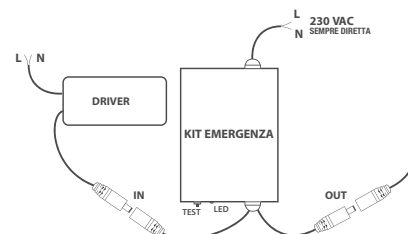

**NEW**

PANNELLI - ACCESSORI

# CONTROLLO

**TOUCH REMOTE RF**

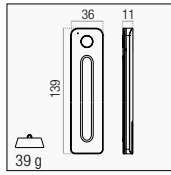

OUTPUT	DISTANCE	BATTERY				
RF (2.4 GHz)	30 m	1x CR2032	Touch Slide 0%-100%	<b>CTLRF NEW</b>	1/100	€ 46,00

Telecomando RF Touch Slide con supporto a parete magnetico  
RF Touch Slide remote control with magnetic wall support

**DIMMER SINGLE COLOR**

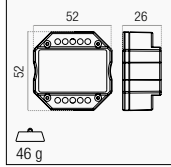

INPUT V.	OUTPUT V.	OUTPUT			
100-240 V/AC	100-240 V/AC	SIGNAL 0/1-10 V (20 mA) 0/1-10 V - Push-Dim	<b>DIM-010 NEW</b>	1/60	€ 58,00

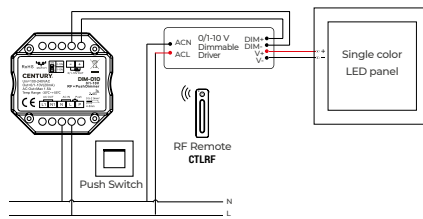

**DAYLIGHT SENSOR**

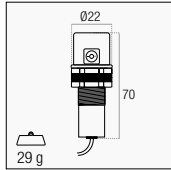

COMPATIBILITY					
Daylight Sensor	Driver 1-10 V <b>DRIMPQ42</b>	<b>SENSDL1-10</b>	1/100	€ 66,00	



Sensore che integra la luce diurna. Regolando il livello di luce desiderato, il sensore miscela la luce proveniente dall'esterno mantenendo sempre la stessa luminosità nella stanza.

Daylight sensor adjusting the light coming from outside maintain the same brightness in the room.

**SENS1**

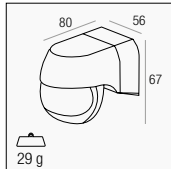

TEMPO DI ACCENSIONE / IGNITION TIME					
Parete / Wall	220-240 V/AC	400 W	Da 10 Sec. ± 3 Sec. a 15 Min. ± 2 Min.	<b>SENS1-18044</b>	1/30 € 19,00



**SENS2**

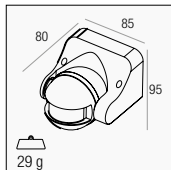

TEMPO DI ACCENSIONE / IGNITION TIME					
Parete / Wall	220-240 V/AC	300 W	Da 10 Sec. ± 3 Sec. a 7 Min. ± 2 Min.	<b>SENS2-18044</b>	1/30 € 17,00



**SENS3**

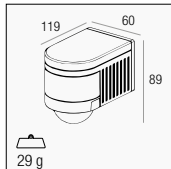

TEMPO DI ACCENSIONE / IGNITION TIME					
Parete / Wall	220-240 V/AC	300 W	Da 10 Sec. ± 3 Sec. a 15 Min. ± 2 Min.	<b>SENS3-36044</b>	1/30 € 30,00



**SENS5**

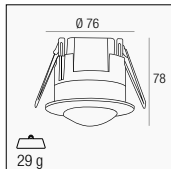

TEMPO DI ACCENSIONE / IGNITION TIME					
Incasto / Recessed	220-240 V/AC	300 W	Da 10 Sec. ± 3 Sec. a 15 Min. ± 2 Min.	<b>SENS5-36020</b>	1/30 € 28,00







IN C A S S O  
IN C A S S O  
**IN C A S S O**  
IN C A S S O  
IN C A S S O

R E C E S S E D  
**R E C E S S E D**  
R E C E S S E D  
R E C E S S E D

INCASSO - DOWNLIGHT

# COMFORT

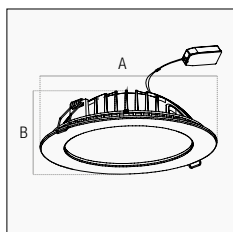

	A mm	B mm	mm	g
8 W	Ø107	40	Ø95-100	159
16 W	Ø172	50	Ø155-160	312
24 W	Ø225	60	Ø210-215	374

1-18 mm

SOURCE		OUTPUT							
8 W	1.030 lm	400 lm	120° ∠	100-277 V/AC 50/60 Hz	3000K	<b>CMF-081130</b>	1/20	€ 24,00	
	4000K				<b>CMF-081140</b>				
16 W	2.090 lm	880 lm	120° ∠	85-265 V/AC 50/60 Hz	3000K	<b>CMF-161830</b>	1/20	€ 38,00	
	4000K				<b>CMF-161840</b>				
24 W	2.850 lm	1.200 lm	120° ∠	110-240 V/AC 50/60 Hz	3000K	<b>CMF-242330</b>	1/20	€ 53,00	
	4000K				<b>CMF-242340</b>				

Emissione di luce indiretta.  
Indirect light emission.

Apparecchio a incasso fisso LED.  
Illuminazione indiretta per un'ottimale ed omogenea distribuzione della luce.

Fixed recessed LED downlight.  
Indirect lighting for optimal and uniform light distribution..



Illuminazione indiretta confortevole per gli occhi.  
Uniform and comfortable indirect lighting for the eyes.

**NEW**

INCASSO - DOWNLIGHT

# ZENO

INCASSO

**CCT**  
3000K-6500K

**ROUND**

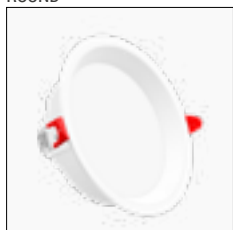

Corpo in alluminio  
Aluminum body

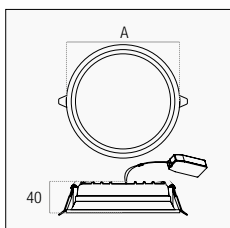

	A mm	mm	g
10 W	Ø90	Ø70	160
16 W	Ø140	Ø120	268
32 W	Ø223	Ø210	460

1-18 mm

	SOURCE		OUTPUT				
10 W	1.000 lm	750 lm	90° ∠	CCT 3000K - 4000K - 6500K	<b>ZNR-1070 NEW</b>	1/20	€ 14,00
16 W	1.500 lm	1.300 lm	100° ∠	CCT 3000K - 4000K - 6500K	<b>ZNR-16120 NEW</b>	1/20	€ 22,00
32 W	4.200 lm	3.500 lm	105° ∠	CCT 3000K - 4000K - 6500K	<b>ZNR-32200 NEW</b>	1/20	€ 38,00

E A G

**SQUARE**



Corpo in alluminio  
Aluminum body

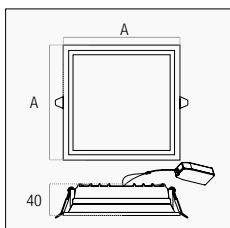

	A mm	mm	g
10 W	90	70x70	170
16 W	140	120x120	313
32 W	223	210x210	566

1-18 mm

	SOURCE		OUTPUT				
10 W	1.000 lm	750 lm	90° ∠	CCT 3000K - 4000K - 6500K	<b>ZNS-1070 NEW</b>	1/20	€ 17,00
16 W	1.500 lm	1.300 lm	100° ∠	CCT 3000K - 4000K - 6500K	<b>ZNS-16120 NEW</b>	1/20	€ 26,00
32 W	4.200 lm	3.500 lm	105° ∠	CCT 3000K - 4000K - 6500K	<b>ZNS-32200 NEW</b>	1/20	€ 43,00

E A G

Downlight LED CCT. Permette la regolazione del colore luce tramite selettore. Adatto ad ogni ambiente interno.

CCT LED downlight. Allows the adjustment of the light color through a switch mode, for every kind of interior ambience.



Regolazione colore luce tramite selettore  
Light color adjustment by switch

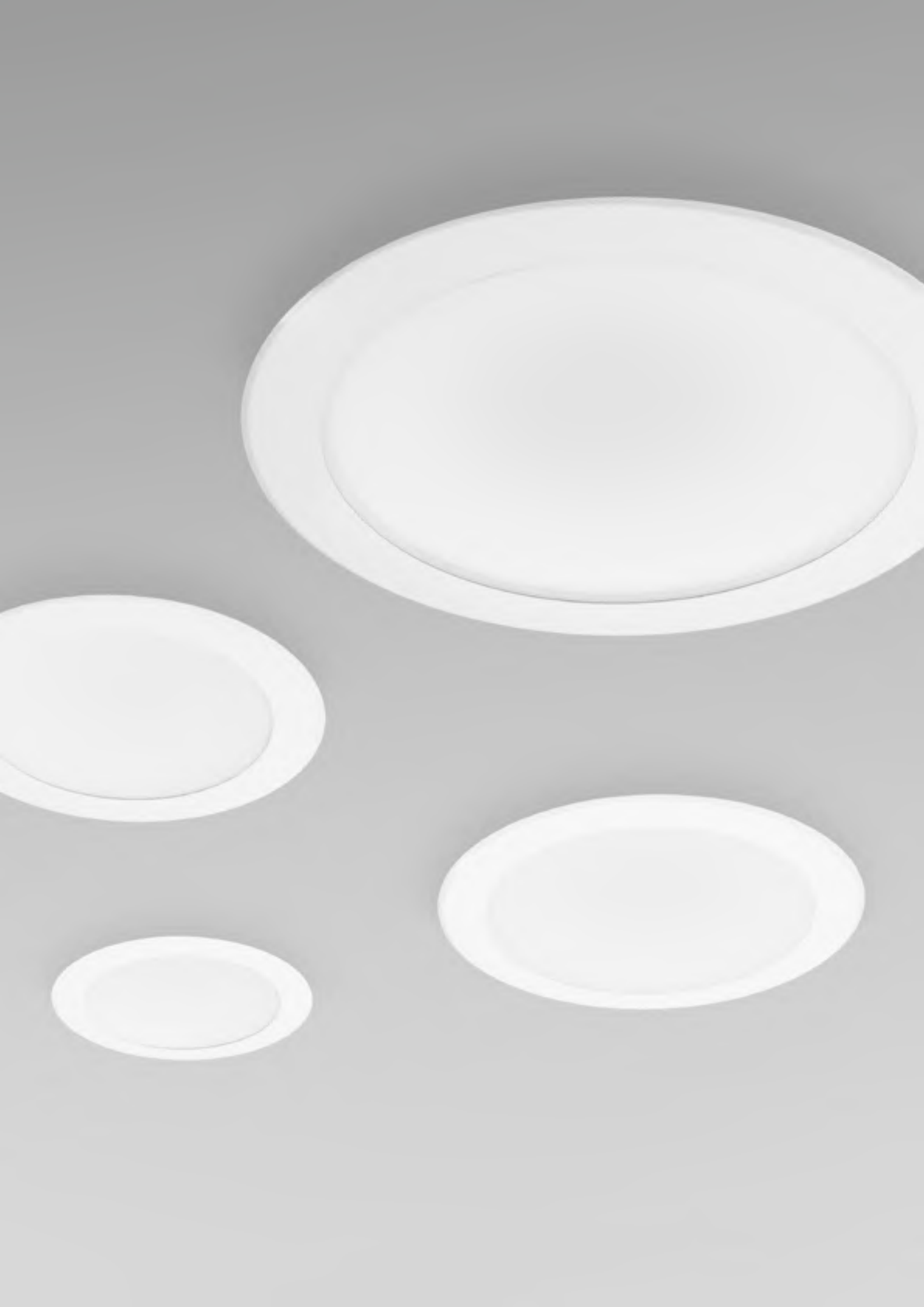

INCASSO - DOWNLIGHT

# SPOTFIVE

## Dimmerabile

INCASSO

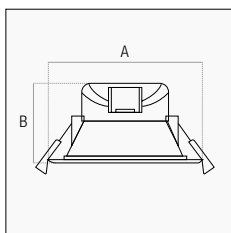

1-18 mm

	A mm	B mm	mm	g
9 W	Ø113	59	Ø92	130
14 W	Ø145	66	Ø130	185
17 W	Ø174	69	Ø150	252
25 W	Ø244	85	Ø205	381

	SOURCE		OUTPUT						
9 W	960 lm	800 lm	120° ∠	Dimm. - CCT	3000K - 4000K - 6000K		<b>SPF-091100</b>	1/20	€ 19,00
14 W	1.510 lm	1.260 lm	120° ∠	Dimm. - CCT	3000K - 4000K - 6000K		<b>SPF-141400</b>	1/20	€ 25,00
17 W	1.860 lm	1.550 lm	120° ∠	Dimm. - CCT	3000K - 4000K - 6000K		<b>SPF-171700</b>	1/20	€ 31,00
25 W	2.940 lm	2.450 lm	120° ∠	Dimm. - CCT	3000K - 4000K - 6000K		<b>SPF-252400</b>	1/20	€ 48,00



Dimmerabile con sistemi Trailing-Edge  
Dimmable with Trailing-Edge systems

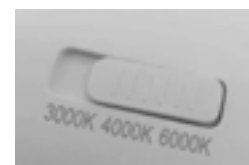

Regolazione tramite selettore sul retro  
Adjustment by selector on the back

Downlight LED CCT. Dimmerabile con sistemi trailing-edge o Led Dimmer.

CCT LED downlight. Dimmable with trailing-edge or Led Dimmer systems.



**CENTURY**





INCASSO - DOWNLIGHT

# FUTURA PRO



INCASSO

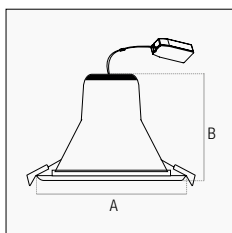

1  
1-18 mm

	A mm	B mm	mm	g
10 W	Ø113	69	Ø90-102	116
15 W	Ø145	82	Ø120-130	166
20 W	Ø174	89	Ø145-155	228
28 W	Ø232	113	Ø195-210	368
35 W	Ø232	113	Ø195-210	368

OUTPUT

10 W	880 lm	60° Δ	Dimm. - UGR<19 - CCT	3000K - 4000K - 6000K	<b>FTP-109000</b>	10/40	€ 33,00
15 W	1.320 lm	60° Δ	Dimm. - UGR<19 - CCT	3000K - 4000K - 6000K	<b>FTP-151200</b>	10/40	€ 41,00
20 W	1.800 lm	60° Δ	Dimm. - UGR<19 - CCT	3000K - 4000K - 6000K	<b>FTP-201400</b>	10/40	€ 45,00
28 W	2.500 lm	60° Δ	Dimm. - UGR<19 - CCT	3000K - 4000K - 6000K	<b>FTP-281900</b>	1/10	€ 61,00
35 W	3.150 lm	60° Δ	Dimm. - UGR<19 - CCT	3000K - 4000K - 6000K	<b>FTP-351900</b>	1/10	€ 68,00



\*Dimmerabile con driver DALI-2 opzionale /  
\*Dimmable with optional DALI-2 driver

7,8 W - 26,3 W	IN 230 V/AC OUT 9-52 V/DC	<b>RDFTPD-1020</b>	1/50	€ 65,00
36 W - 44 W	IN 230 V/AC OUT 9-52 V/DC	<b>RDFTPD-2835</b>	1/50	€ 70,00

Downlight LED CCT. Dotato di speciale parabola riflettente specchiata che consente di raggiungere UGR<19.

CCT LED downlight. Equipped with a special mirrored reflector that to grant UGR <19.



Regolazione tramite selettore sul retro  
Adjustment by selector on the back



CENTURY

# FUTURA SHOP 95

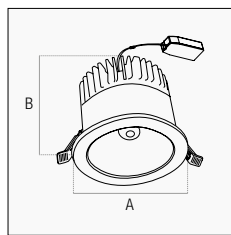

1-25 mm

	A mm	B mm	mm	g
30 W	Ø170	100	Ø115-120	530
60 W	Ø230	137	Ø195-205	1790

OUTPUT

30 W	2.530 lm	36° ∠	Dimm. - CRI 95	3000K	<b>FTS-301330</b>	1/20	€ 65,00
				4000K	<b>FTS-301340</b>		
60 W	5.260 lm	60° ∠	Dimm. - CRI 95	3000K	<b>FTS-602330</b>	1/20	€ 120,00
				4000K	<b>FTS-602340</b>		

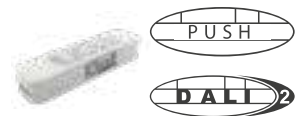

\*Dimmerabile con driver DALI-2 opzionale /  
\*Dimmable with optional DALI-2 driver

31 W - 60 W	IN 230 V/AC OUT 9-52 V/DC	<b>RDFTPD-60</b>	1/50	€ 90,00
36 W - 44 W	IN 230 V/AC OUT 9-52 V/DC	<b>RDFTPD-2835</b>	1/50	€ 70,00

Downlight realizzati in alluminio pressofuso ad alto potere dissipante con chip Led CRI95 per una resa perfetta dei colori. Driver incluso.

Downlights made of die-cast aluminum with high dissipating power and CRI95 Led chip for perfect color rendering. Driver included.



# FUTURA SHOP 95

## Dimmerabile

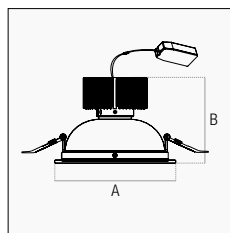

1-28 mm

	A mm	B mm	mm	g
22 W	Ø170	114	Ø153	534
28 W	Ø230	125	Ø200	900
39 W	Ø230	135	Ø205	920
50 W	Ø170	106	Ø153	920

OUTPUT

22 W	2.030 lm	60° ∠	Dimm. - CRI 95	4000K	FTSD-221740	2/8	€ 120,00
28 W	2.320 lm	90° ∠	Dimm. - CRI 95	3000K	FTSD-282330	2/8	€ 146,00
	2.525 lm	90° ∠	Dimm. - CRI 95	4000K	FTSD-282340		
39 W	3.257 lm	90° ∠	Dimm. - CRI 95	3000K	FTSD-392330	2/8	€ 173,00
50 W	4.340 lm	90° ∠	Dimm. - CRI 95	3000K	FTSD-501730	2/8	€ 182,00

Downlight CRI95 dimmerabile con sistemi trailing-edge o Led Dimmer.

CRI95 dimmable downlight with trailing-edge or Led Dimmer systems.



Dimmerabile con sistemi Trailing-Edge  
Dimmable with Trailing-Edge systems

INCASSO - DOWNLIGHT

# FUTURA

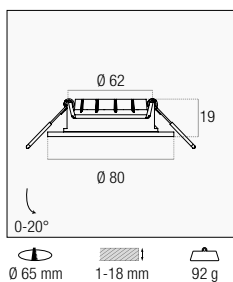

OUTPUT

6 W	450 lm	36° $\triangle$	3000K <span style="color: yellow;">■</span>	<b>FT-066830</b>	1/10	€ 10,00
			4000K <span style="color: green;">■</span>	<b>FT-066840</b>		



SUPERSLIM con soli 19mm di spessore, consente installazioni in controsoffitti anche con minimo spazio. Testa orientabile.

SUPERSLIM with only 19mm thickness, for false ceilings installation even with minimum space. Adjustable head.



Superslim con soli 19 mm di spessore  
Superslim with only 19 mm thickness

INCASSO - DOWNLIGHT

# FUTURA ADVANCE

## Kit 3 pz

UGR  
<19

INCASSO

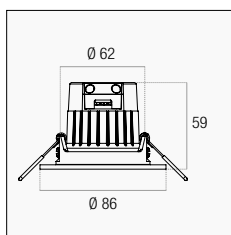

Ø 65 mm    1-18 mm    87 g

### OUTPUT

3 x 6 W	3x 450 lm	38° ∠	UGR<19	Bianco / White ○	3000K	<b>KITFTA-060830</b>	1/10	€ 30,00
---------	-----------	-------	--------	------------------	-------	----------------------	------	---------

Corpo in materiale plastico Heat-Sink, con testa orientabile. Alimentatore interno, anello in finitura bianca.

Heat-Sink plastic material, body with adjustable head. Internal power supply, white finish ring.

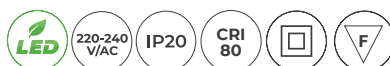

Precabfato, pronto all'uso!  
Pre-wired, ready to use!



# VENUS SHOP

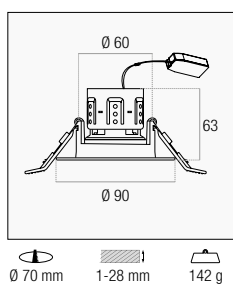

OUTPUT

8,5 W	742 lm	38° ∠	Dimm. - CRI 95	4000K	<b>VS-853840</b>	10/40	€ 40,00
-------	--------	-------	----------------	-------	------------------	-------	---------

Downlight realizzati in alluminio pressofuso ad alto potere dissipante con chip Led CRI95 per una resa perfetta dei colori. Driver incluso.

Downlights made of die-cast aluminum with high dissipating power and CRI95 Led chip for perfect color rendering. Driver included.



Dimmerabile con sistemi Trailing-Edge  
Dimmable with Trailing-Edge systems



INCASSO - DOWNLIGHT

# REGIA SHOP



INCASSO



8 W



25 W - 36 W

8 W

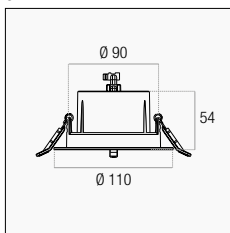

Ø 90 mm   1-28 mm   240 g

25 W - 36 W

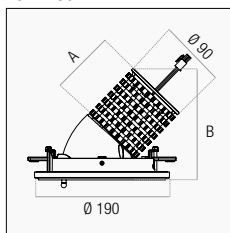

1-25 mm

	A mm	B mm	mm	g
25 W	88	156	Ø158	1070
36 W	112	174	Ø158	1130

OUTPUT

Power	Output (lm)	Beam Angle	Dimmable	CRI	Color Temp	Product Code	Packaging	Price
8 W	710 lm	38°	Dimm.	- CRI 95	3000K	<b>RGOD-089030</b>	6/24	€ 60,00
	730 lm	38°	Dimm.	- CRI 95	4000K	<b>RGOD-089040</b>	6/24	€ 60,00
25 W	2.150 lm	38°	Dimm.	- CRI 95	3000K	<b>RGOD-259030</b>	6/24	€ 146,00
36 W	3.020 lm	38°	Dimm.	- CRI 95	3000K	<b>RGOD-369030</b>	6/24	€ 199,00
	3.240 lm	38°	Dimm.	- CRI 95	4000K	<b>RGOD-369040</b>		

Downlight CRI95 dimmerabile con sistemi trailing-edge o Led Dimmer.

CRI95 dimmable downlight with trailing-edge or Led Dimmer systems.



Dimmerabile con sistemi Trailing-Edge Dimmable with Trailing-Edge systems





# REGIA SHOP

## Dimmerabile



1 SLOT

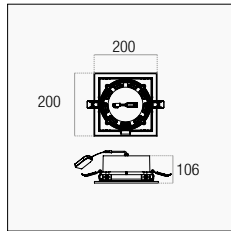

175 x 175 mm 1-28 mm 760 g

OUTPUT

15 W	1.230 lm	38° ∠	Dimm. - CRI 95	3000K	<b>FSMD1-150130</b>	1/6	€ 146,00
	1.265 lm	38° ∠	Dimm. - CRI 95	4000K	<b>FSMD1-150140</b>		

2 SLOT

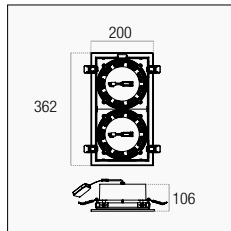

335 x 175 mm 1-28 mm 1518 g

OUTPUT

30 W	2.460 lm	38° ∠	Dimm. - CRI 95	3000K	<b>FSMD2-300230</b>	1/6	€ 238,00
------	----------	-------	----------------	-------	---------------------	-----	----------

3 SLOT

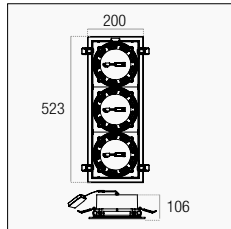

497 x 175 mm 1-28 mm 2278 g

OUTPUT

45 W	3.690 lm	38° ∠	Dimm. - CRI 95	3000K	<b>FSMD3-450330</b>	1/6	€ 358,00
	3.795 lm	38° ∠	Dimm. - CRI 95	4000K	<b>FSMD3-450340</b>		

Downlight CRI95 a 1, 2 o 3 slot dimmerabile con sistemi Trailing-Edge o Led Dimmer.

CRI95 downlight with 1, 2 or 3 slots dimmable with Trailing-Edge or Led Dimmer systems.



Dimmerabile con sistemi Trailing-Edge  
Dimmable with Trailing-Edge systems

INCASSO

# MINIMAL



MNI  
Incasso / Recessed



MNC  
Cartongesso / Plasterboard



## INCASSO / RECESSED

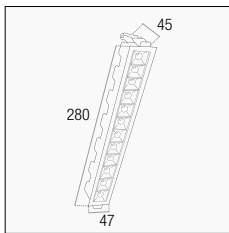

35 x 270 mm 1-28 mm 45 g

## CARTONGESSO / PLASTERBOARD

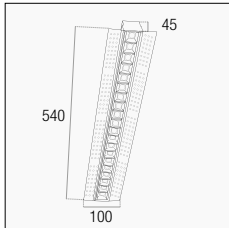

45 x 540 mm 1-28 mm 980 g

### OUTPUT

20 W	1.100 lm	45° ∠	CRI 95	3000K	<b>MNI-204530</b>	1/12	€ 113,00
	1.200 lm	45° ∠	CRI 95	4000K	<b>MNI-204540</b>		

### OUTPUT

20 W	1.300 lm	45° ∠	CRI 95	3000K	<b>MNC-204530</b>	1/12	€ 132,00
	1.500 lm	45° ∠	CRI 95	4000K	<b>MNC-204540</b>		

Apparecchio per installazione ad incasso.  
Lenti da 28 mm per effetto taglio di luce.

Appliance for recessed installation.  
28 mm lens for light blade effect.



Rapida installazione con sistema magnetico  
Quick installation with magnetic system

Cavo in acciaio per protezione anticaduta incluso.  
Steel cable for fall protection included.



**NEW**

INCASSO

# LINEA-R

Dimmerabile



INCASSO

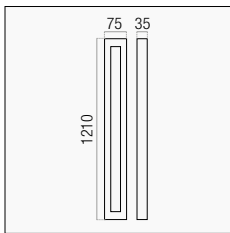

65 x 1205 mm 1-20 mm 1162 g

OUTPUT

36 W	4.800 lm	105° ∠	Dimm. - No Driver	Bianco / White ○ RAL 9003	3000K	<b>LNR-361230 NEW</b>	1/10	€ 94,00
					4000K	<b>LNR-361240 NEW</b>		

\*36 V/DC - 1000 mA Constant Current



Da completare con driver /  
To complete with driver

No Dimm.	<b>RDPQA42120</b>	1/100	€ 22,00
1-10 V	<b>DRIMPQ42</b>	1/50	€ 40,00
DALI-2 - PUSH DIM	<b>DRIMPQ42D</b>	1/100	€ 54,00



Sistema lineare di design ad incasso.  
**Dimmerabile** tramite driver dedicati.

Recessed linear design system.  
**Dimmable** through dedicated drivers.



Fissaggio con clip a molla.  
Spring clip fixing.



**CENTURY**







INCASSO  
INCASSO  
**INCASSO**  
INCASSO  
INCASSO

SUPPORTI  
SUPPORTI  
**SUPPORTI**  
SUPPORTI  
SUPPORTI

SUPPORTS  
SUPPORTS  
**SUPPORTS**  
SUPPORTS  
SUPPORTS

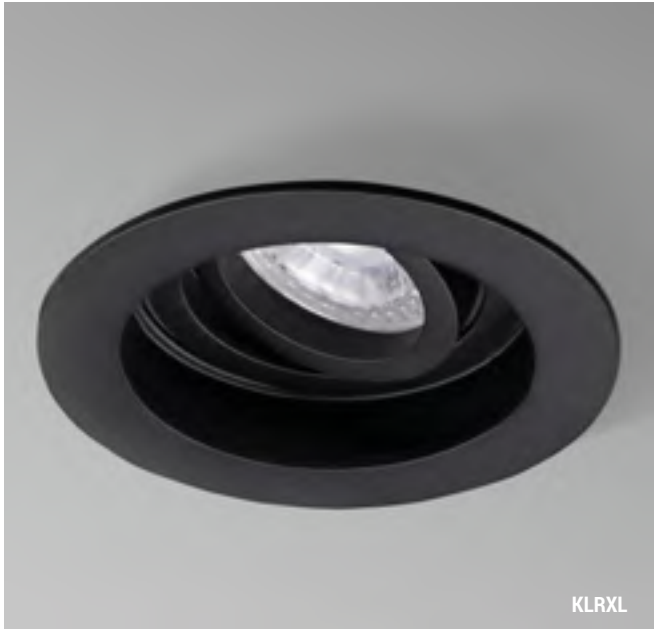

# KLAK

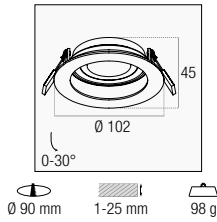

Orientabile / Adjustable	Bianco / White ○	<b>KLRXL-BI</b>	10/50	€ 13,00
	Nero / Black ●	<b>KLRXL-NE</b>		

Attacco GU10 con box di collegamento professionale  
GU10 socket with professional connection box

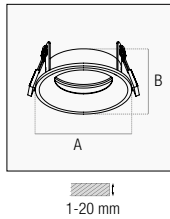

Fisso / Fixed	A	B			Bianco / White ○	<b>KLRFX-BI</b>	10/50	€ 16,00
	Ø76	23	Ø65	61 g	Nero / Black ●	<b>KLRFX-NE</b>		
	Ø79	31	Ø72	54 g	B/W + N/B ○●	<b>KLRFX-BN</b>	10/50	€ 12,00

Attacco GU10 con box di collegamento professionale  
GU10 socket with professional connection box

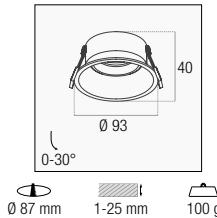

Orientabile / Adjustable	Bianco / White ○	<b>KLRCON-BI</b>	10/50	€ 13,00
	Nero / Black ●	<b>KLRCON-NE</b>		

Attacco GU10 con box di collegamento professionale  
GU10 socket with professional junction box

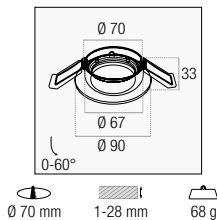

Orientabile / Adjustable	Argento / Silver ●	<b>KLR-AR</b>	10/50	€ 9,00
	Bianco / White ○	<b>KLR-BI</b>	10/50	€ 8,00
	Cromo / Chrome ●	<b>KLR-CR</b>	10/50	€ 9,00

Sistema a scatto brevettato, portalamпада GU10 incluso.  
Patented snap system, GU10 lamp holder included.

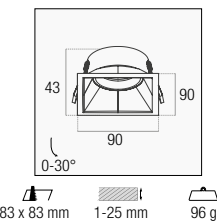

Orientabile / Adjustable	Bianco / White ○	<b>KLSCON-BI</b>	10/50	€ 14,00
	Nero / Black ●	<b>KLSCON-NE</b>	10/50	€ 13,00

Attacco GU10 con box di collegamento professionale  
GU10 socket with professional junction box

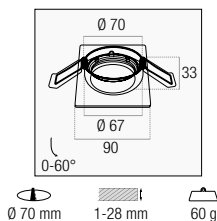

Orientabile / Adjustable	Argento / Silver ●	<b>KLS-AR</b>	10/50	€ 9,00
	Bianco / White ○	<b>KLS-BI</b>	10/50	€ 8,00
	Cromo / Chrome ●	<b>KLS-CR</b>	10/50	€ 9,00

Sistema a scatto brevettato, portalamпада GU10 incluso.  
Patented snap system, GU10 lamp holder included.



GU10

Non inclusa / Not included  
Vedi / Ref.

LEXAR - DICRO SHOP95 - SPOT MULTILED

Eleganti supporti per lampade spot.  
Corpo in alluminio pressofuso.

Elegant supports for spot lamps.  
Die-cast aluminum body.



# KLIK Round

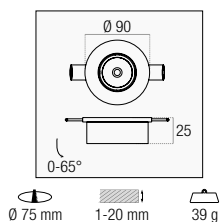

Profonda / Deep	Bianco / White ○	<b>KLIRL</b>	10/50	€ 3,50
-----------------	------------------	--------------	-------	--------

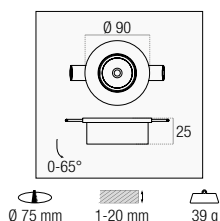

Spirale / Spiral	Bianco / White ○	<b>KLIRM</b>	10/50	€ 3,10
------------------	------------------	--------------	-------	--------

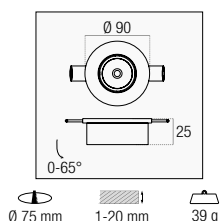

Superficie / Surface	Bianco / White ○	<b>KLIRS</b>	10/50	€ 3,10
----------------------	------------------	--------------	-------	--------

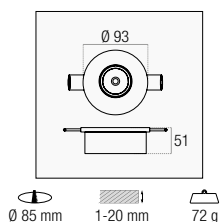

A scomparsa / Concealed	Bianco / White ○	<b>KLIRXL</b>	10/50	€ 5,00
-------------------------	------------------	---------------	-------	--------

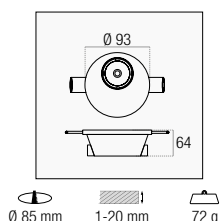

A scomparsa decentrata / Concealed decentralized	Bianco / White ○	<b>KLIRXLD</b>	10/50	€ 5,00
--	------------------	----------------	-------	--------



Portalampane GU10 / GU5.3 opzionale  
Optional GU10 / GU5.3 lampholder

<b>PLGU10</b>	10/1000	€ 1,20
<b>PLGU53</b>		

Faretti ad incasso orientabili in ABS.  
Montaggio lampada (non inclusa) a scatto.

Adjustable recessed spotlights in ABS.  
Snap-on lamp (not included) assembly.

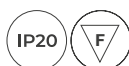

# KLIK Square

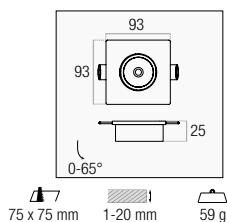

Profonda / Deep	Bianco / White ○	<b>KLISL</b>	10/50	€ 4,00
-----------------	------------------	--------------	-------	--------

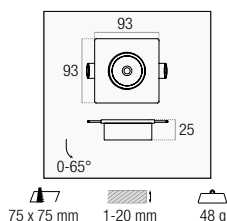

Spirale / Spiral	Bianco / White ○	<b>KLISM</b>	10/50	€ 3,50
------------------	------------------	--------------	-------	--------

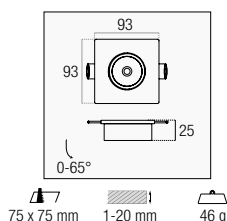

Superficie / Surface	Bianco / White ○	<b>KLISS</b>	10/50	€ 3,50
----------------------	------------------	--------------	-------	--------

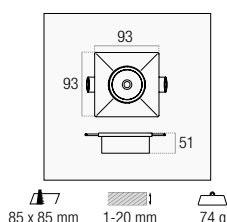

A scomparsa / Concealed	Bianco / White ○	<b>KLISXL</b>	10/50	€ 5,00
-------------------------	------------------	---------------	-------	--------

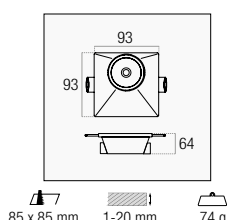

A scomparsa decentrata / Concealed decentralized	Bianco / White ○	<b>KLISXLD</b>	10/50	€ 5,00
--	------------------	----------------	-------	--------



Portalampane GU10 / GU5.3 opzionale  
Optional GU10 / GU5.3 lampholder

<b>PLGU10</b>	10/1000	€ 1,20
<b>PLGU53</b>		

Faretti ad incasso orientabili in ABS.  
Montaggio lampada (non inclusa) a scatto.

Adjustable recessed spotlights in ABS.  
Snap-on lamp (not included) assembly.



# KLIK Double

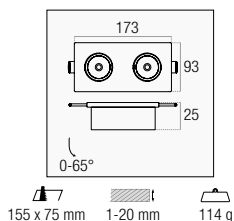

Profonda / Deep	Bianco / White ○	<b>KLISL2</b>	10/50	€ 7,50
-----------------	------------------	---------------	-------	--------

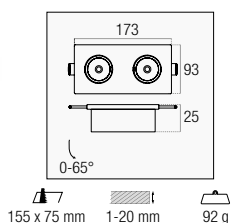

Spirale / Spiral	Bianco / White ○	<b>KLISM2</b>	10/50	€ 7,00
------------------	------------------	---------------	-------	--------

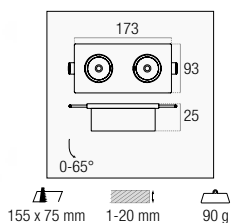

Superficie / Surface	Bianco / White ○	<b>KLISS2</b>	10/50	€ 7,00
----------------------	------------------	---------------	-------	--------

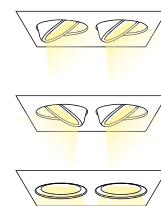

Orientamento libero  
Free orientation



Portalampane GU10 / GU5.3 opzionale  
Optional GU10 / GU5.3 lampholder

<b>PLGU10</b>	10/1000	€ 1,20
<b>PLGU53</b>		

Faretti ad incasso orientabili in ABS.  
Montaggio lampada (non inclusa) a scatto.  
Doppia fonte luminosa dallo stile inconfondibile.

Adjustable recessed spotlights in ABS.  
Snap-on lamp (not included) assembly.  
Double light source with an unmistakable style.

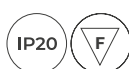

# CITY FRAME



CF1P

CF2P

CF3P

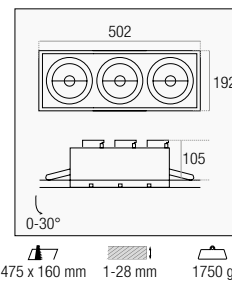
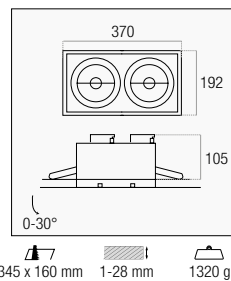
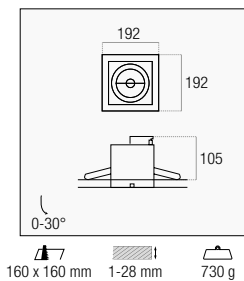

CF1P-AR111	1/16	€ 41,00
------------	------	---------

CF2P-AR111	1/8	€ 62,00
------------	-----	---------

CF3P-AR111	1/8	€ 84,00
------------	-----	---------

## Montaggio / Assembly

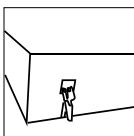

Smontare la molla supplementare nera d'acciaio.  
Remove the black supplementary spring steel.

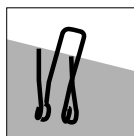

Fare aderire la parte lunga della molla al corpo del Frame.  
Adhere the long part of the spring to the body of the Frame.

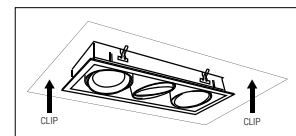

Spingere il Frame fino all'autobloccaggio.  
Push the Frame until self-locking.

Struttura in acciaio e cornice in alluminio.  
Orientabile di 30° sui due assi.  
Sistema di aggancio rapido al controsoffitto.

Steel structure and aluminum frame.  
Adjustable by 30° on both axes.  
Quick attachment system to the false ceiling.



AR111 AR111

Non inclusa / Not included  
Vedi / Ref.

SUPERLED - CITY LAMP





PLAFONIERE  
PLAFONIERE  
**PLAFONIERE**  
PLAFONIERE  
PLAFONIERE

CEILING LIGHTS  
CEILING LIGHTS  
**CEILING LIGHTS**  
CEILING LIGHTS  
CEILING LIGHTS

UP

PLAFONIERE

# BLANCA PERLA



	A mm	B mm	g
14 W	Ø265	100	297
20 W	Ø290	100	523
24 W	Ø345	100	464
32 W	Ø380	95	700

	SOURCE		OUTPUT					
14 W	1.380 lm	1.100 lm	160° ∠	4000K		<b>BCP-122840 UPGRADE</b>	1/6	€ 29,00
20 W	1.900 lm	1.520 lm	160° ∠	4000K		<b>BCP-183340 UPGRADE</b>	1/6	€ 36,00
24 W	2.500 lm	1.800 lm	160° ∠	4000K		<b>BCP-243840 UPGRADE</b>	1/6	€ 48,00
32 W	2.800 lm	2.240 lm	160° ∠	4000K		<b>BCP-323840 UPGRADE</b>	1/6	€ 53,00

New design  
Better performance



Plafoniera LED con finitura perlata, ideale per applicazioni a soffitto o parete, dal flusso luminoso uniforme.

LED ceiling light with a pearly finish, ideal for ceiling or wall applications, with a uniform luminous flux.



Perfetta per ogni ambiente  
Perfect for every kind of ambience

PLAFONIERE

# BLANCA SLIM

PLAFONIERE



	A mm	B mm	g g
14 W	Ø245	55	217
20 W	Ø330	65	437
24 W	Ø375	75	566
32 W	Ø390	65	670

SOURCE		OUTPUT					
14 W	1.550 lm	1.090 lm	120° ∠	3000K	<b>BCS-142530</b>	1/10	€ 19,00
				4000K	<b>BCS-142540</b>		
20 W	2.200 lm	1.550 lm	120° ∠	3000K	<b>BCS-203030</b>	1/10	€ 26,00
				4000K	<b>BCS-203040</b>		
24 W	2.800 lm	1.800 lm	120° ∠	3000K	<b>BCS-243530</b>	1/10	€ 31,00
				4000K	<b>BCS-243540</b>		
32 W	3.380 lm	2.750 lm	120° ∠	3000K	<b>BCS-323930</b>	1/10	€ 38,00
				4000K	<b>BCS-323940</b>		

Applicazione a soffitto e parete, come plafoniera o applique. Flusso luminoso uniforme.

Ceiling and wall application. Uniform luminous flux.

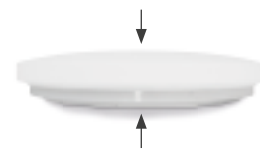
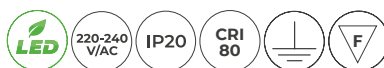

Ultraslim, da 55 a 75 mm di spessore  
Ultraslim, from 55 to 75 mm thick



# PRATIKA

## Sensor - Emergenza

### STANDARD

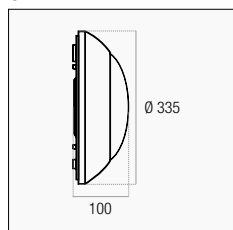

980 g

SOURCE		OUTPUT						
18 W	1.600 lm	1.200 lm	120° ∠	Standard	4000K	<b>PRK-183240</b>	1/6	€ 60,00

### SENSOR

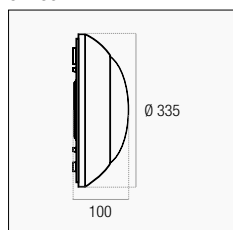

980 g

SOURCE		OUTPUT						
18 W	1.450 lm	1.200 lm	120° ∠	PIR Sensor	4000K	<b>PRKS-183240</b>	1/6	€ 89,00



### EMERGENCY

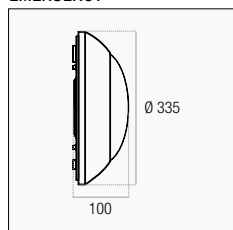

1300 g

SOURCE		OUTPUT						
18 W	1.450 lm	1.200 lm	120° ∠	3h Emergenza / Emergency	4000K	<b>PRKE-183240</b>	1/6	€ 118,00



Applicazione a soffitto e parete, come plafoniera o applique, con flusso luminoso uniforme. Accensione automatica in caso di blackout. Modalità Emergenza 2,5 W - 150 lm. Elevata resistenza agli urti.

Ceiling and wall application, as ceiling or wall lamp, with uniform luminous flux. Automatic power on in case of blackout. Emergency mode 2.5 W - 150 lm. High impact resistance.

Ricambio driver opzionale  
Optional driver replacement

<b>RDPRK</b>	€ 16,00
--------------	---------

Ricambio driver emergenza opzionale  
Optional emergency driver replacement

<b>RDPRKE NEW</b>	€ 13,00
-------------------	---------







OSOB



OSONS



OSTON



OSTOBS



OSTOBP



OSTONPS



# OASI

## OVAL

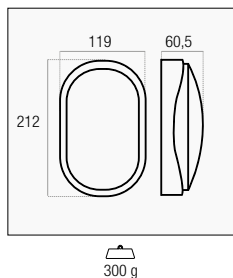

SOURCE		OUTPUT							
14 W	1.600 lm	1.000 lm	120° ∠	Bianco / White ○	-	4000K	<b>OSOB-1411940</b>	1/12	€ 19,00
					PIR Sensor	4000K	<b>OSOBS-1411940</b>	1/12	€ 41,00
				Nero / Black ●	-	4000K	<b>OSON-1411940</b>	1/12	€ 19,00
					PIR Sensor	4000K	<b>OSONS-1411940</b>	1/12	€ 41,00

## ROUND

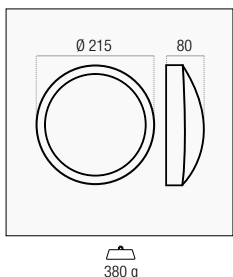

SOURCE		OUTPUT							
14 W	1.600 lm	1.000 lm	120° ∠	Bianco / White ○	-	4000K	<b>OSTOB-1421540</b>	1/12	€ 23,00
					PIR Sensor	4000K	<b>OSTOBS-1421540</b>	1/12	€ 43,00
				Nero / Black ●	-	4000K	<b>OSTON-1421540</b>	1/12	€ 23,00
					PIR Sensor	4000K	<b>OSTONS-1421540</b>	1/12	€ 43,00

## ROUND + PALPEBRA / EYELID

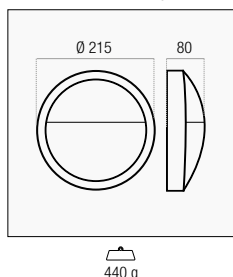

SOURCE		OUTPUT							
14 W	1.600 lm	1.000 lm	120° ∠	Bianco / White ○	-	4000K	<b>OSTOBP-1421540</b>	1/12	€ 25,00
					PIR Sensor	4000K	<b>OSTOBPS-1421540</b>	1/12	€ 48,00
				Nero / Black ●	-	4000K	<b>OSTONP-1421540</b>	1/12	€ 25,00
					PIR Sensor	4000K	<b>OSTONPS-1421540</b>	1/12	€ 48,00

Plafoniera da interno o da esterno protetto.  
Applicazioni soffitto-pareti con flusso luminoso uniforme.

Indoor or outdoor protected ceiling light.  
Ceiling-wall applications with uniform luminous flux.



PLAFONIERE

# OASI 65 PLUS



	A mm	B mm	g
18 W	60	Ø230	522
36 W	65	Ø320	835

OUTPUT							
18 W	1.820 lm	120° ∠	CCT 3000K - 4000K - 6500K		<b>OS65P-182300</b>	1/10	€ 42,00
36 W	3.820 lm	120° ∠	CCT 3000K - 4000K - 6500K		<b>OS65P-363200</b>	1/10	€ 62,00



Plafoniera IP65 ideale per ambienti esterni ed interni umidi. Tramite il selettore sul retro è possibile scegliere il colore luce desiderato.

IP65 ceiling light ideal for outdoor and humid interiors ambience. Using the selector on the back it's possible to choose the desired light color.

Staffa circolare per rapida installazione  
Round bracket for fast installation

230 V/AC

Passacavo PG 7  
Cable gland PG 7

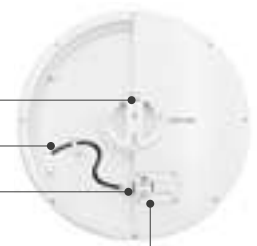

DIP-SWITCH

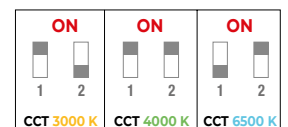

PLAFONIERE

# PUSH & GO

PLAFONIERE



	A	B	
	A mm	B mm	g
10 W	Ø180	37	289
20 W	Ø228	40	444

OUTPUT						
10 W	600 lm	160° ∠	3000K	<b>PHG-1018030</b>	1/20	€ 26,00
			4000K	<b>PHG-1018040</b>		
20 W	1.200 lm	160° ∠	3000K	<b>PHG-2023030</b>	1/20	€ 38,00
			4000K	<b>PHG-2023040</b>		

2 modalità / 2 modes

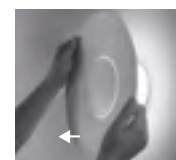
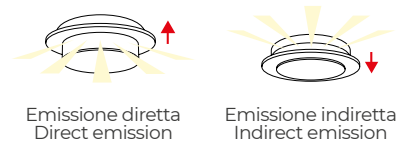

Plafoniera per interno/esterno, con duplice modalità di emissione luminosa: diretta e indiretta.

Indoor / outdoor ceiling light, with dual light emission modes: direct and indirect.





**NEW**

PLAFONIERE

# PURA

PLAFONIERE

SQUARE PARABOLA

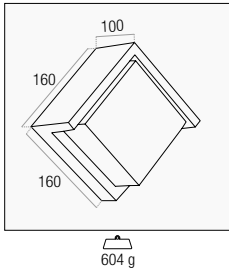

OUTPUT							
10 W	850 lm	120° ∠	Bianco / White ○	3000K	<b>PACBI-101630 NEW</b>	1/6	€ 41,00
				4000K	<b>PACBI-101640 NEW</b>		
			Grigio Antracite / Anthracite Grey ●	3000K	<b>PACGR-101630 NEW</b>		
				4000K	<b>PACGR-101640 NEW</b>		



ROUND

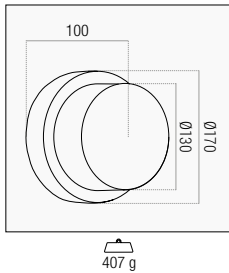

OUTPUT							
10 W	850 lm	120° ∠	Bianco / White ○	3000K	<b>PARBI-101730 NEW</b>	1/6	€ 36,00
				4000K	<b>PARBI-101740 NEW</b>		
			Grigio Antracite / Anthracite Grey ●	3000K	<b>PARGR-101730 NEW</b>		
				4000K	<b>PARGR-101740 NEW</b>		



SQUARE

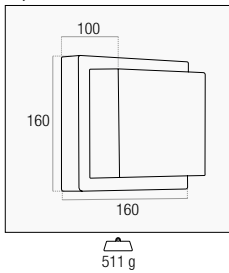

OUTPUT							
10 W	850 lm	120° ∠	Bianco / White ○	3000K	<b>PASBI-101630 NEW</b>	1/6	€ 38,00
				4000K	<b>PASBI-101640 NEW</b>		
			Grigio Antracite / Anthracite Grey ●	3000K	<b>PASGR-101630 NEW</b>		
				4000K	<b>PASGR-101640 NEW</b>		



Plafoniere LED ideali per illuminare con stile ogni ambiente esterno.

LED ceiling lights suitable for stylish outdoor ambiances.

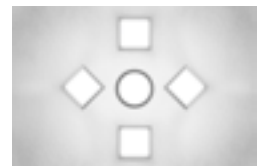

Prova diverse combinazioni!  
Try different combinations!



ROUND



SQUARE

**NEW**

PLAFONIERE

# OMNIA

PLAFONIERE

**ROUND**

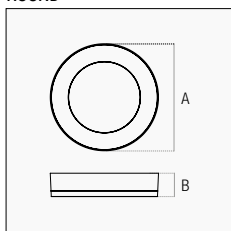

	A mm	B mm	g
6 W	Ø190	42	370
24 W	Ø320	50	966

OUTPUT

6 W	600 lm	120°	Piastra intercambiabile / Interchangeable plate 	3000K	<b>OMR-061930 NEW</b>	1/24	€ 26,00
				4000K	<b>OMR-061940 NEW</b>		
24 W	2.500 lm	120°	Piastra intercambiabile / Interchangeable plate 	3000K	<b>OMR-243230 NEW</b>	1/10	€ 55,00
				4000K	<b>OMR-243240 NEW</b>		



**SQUARE**

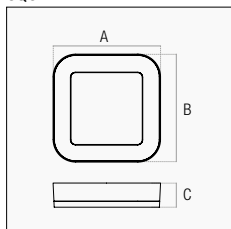

	A mm	B mm	C mm	g
6 W	190	190	42	425
24 W	320	320	50	1113

OUTPUT

6 W	600 lm	120°	Piastra intercambiabile / Interchangeable plate 	3000K	<b>OMS-061930 NEW</b>	1/24	€ 26,00
				4000K	<b>OMS-061940 NEW</b>		
24 W	2.500 lm	120°	Piastra intercambiabile / Interchangeable plate 	3000K	<b>OMS-243230 NEW</b>	1/10	€ 55,00
				4000K	<b>OMS-243240 NEW</b>		



Plafoniere LED da esterno fornite di piastre magnetiche intercambiabili in 4 finiture per una facile personalizzazione degli ambienti.

Installazione a parete o a soffitto.

Outdoor LED ceiling light with 4 different interchangeable magnetic plates to easily customize ambiances. Wall or ceiling installation.



**1 Prodotto, 4 Colorazioni**

Scegli tra Bianco, Oro, Argento e Nero.

**1 Product, 4 Colors**

Choose between White, Gold, Silver and Black.







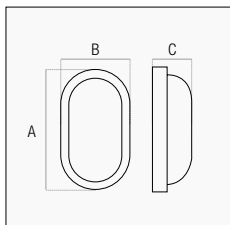

# SIMPLY

OVAL





	A mm	B mm	C mm	g
16 W	214	115	64	250
24 W	270	146	70	407

		OUTPUT			
16 W	1.280 lm	120° ∠	Bianco / White ○ 4000K	<b>SMO-162240</b>	1/20  € 17,00
			Nero / Black ● 4000K	<b>SMON-162240</b>	
24 W	1.920 lm	120° ∠	Bianco / White ○ 4000K	<b>SMO-242740</b>	1/20  € 26,00
			Nero / Black ● 4000K	<b>SMON-242740</b>	

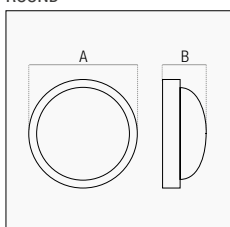
ROUND





	A mm	B mm	g
16 W	Ø166	63	227
24 W	Ø220	69	490

		OUTPUT			
16 W	1.280 lm	120° ∠	Bianco / White ○ 4000K	<b>SMR-161740</b>	1/20  € 17,00
			Nero / Black ● 4000K	<b>SMRN-161740</b>	
24 W	1.920 lm	120° ∠	Bianco / White ○ 4000K	<b>SMR-242240</b>	1/20  € 26,00
			Nero / Black ● 4000K	<b>SMRN-242240</b>	

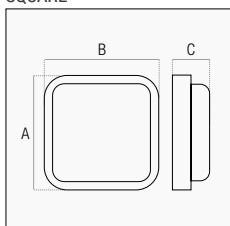
SQUARE



	A mm	B mm	C mm	g
16 W	150	150	62	247
24 W	220	220	73	467

		OUTPUT			
16 W	1.280 lm	120° ∠	Bianco / White ○ 4000K	<b>SMS-161540</b>	1/20  € 17,00
			Nero / Black ● 4000K	<b>SMSN-161540</b>	
24 W	1.920 lm	120° ∠	Bianco / White ○ 4000K	<b>SMS-242240</b>	1/20  € 26,00
			Nero / Black ● 4000K	<b>SMSN-242240</b>	

Plafoniera IP65 a led integrato ideale per tutti gli ambienti esterni ed interni umidi. Disponibile in forme e finiture diverse per adattarsi meglio all'ambiente circostante.

IP65 integrated LED ceiling light suitable outdoor and humid interiors ambience. Available in different shapes and finishes to fit any locations.





SISTEMI LINEARI  
SISTEMI LINEARI  
**SISTEMI LINEARI**  
SISTEMI LINEARI  
SISTEMI LINEARI

STRIP LED  
STRIP LED  
**STRIP LED**  
STRIP LED  
STRIP LED



7,2 W/m



13,4 W/m



19 W/m



24 W/m

# ACCÈNTO PRO



SIST. LINEARI

	A mm	g	mm
36 W	8	88	165
67 W	10	92	100
95 W	10	115	50
120 W	10	131	25

36 W (7,2 W/m)	2.900 lm (580 lm/m)	30 led/m	CRI 90	3000K	<b>AC90-723030</b>	10/20	€ 34,00
				4000K	<b>AC90-723040</b>		
				6000K	<b>AC90-723060</b>		
67 W (13,4 W/m)	6.740 lm (1.348 lm/m)	60 led/m	CRI 90	3000K	<b>AC90-146030</b>	10/20	€ 49,00
				4000K	<b>AC90-146040</b>		
				6000K	<b>AC90-146060</b>		
95 W (19 W/m)	9.450 lm (1.890 lm/m)	120 led/m	CRI 90	3000K	<b>AC90-2012030</b>	10/20	€ 74,00
	10.120 lm (2.024 lm/m)	120 led/m	CRI 90	4000K	<b>AC90-2012040</b>		
	10.190 lm (2.038 lm/m)	120 led/m	CRI 90	6000K	<b>AC90-2012060</b>		
120 W (24 W/m)	12.150 lm (2.430 lm/m)	240 led/m	CRI 90	3000K	<b>AC90-2424030</b>	10/20	€ 139,00
				4000K	<b>AC90-2424040</b>		
				6000K	<b>AC90-2424060</b>		

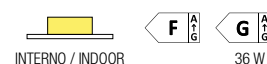

Strip LED professionale per interni, per una perfetta resa naturale dei colori.

Professional indoor LED strip, for a perfect natural color rendering.



**3M VHB**  
Extra strong  
Potere dissipante / Dissipation power

Alimentatori e accessori  
Power supplies and accessories  
**PAG. 114-115**

# ACCÈNTO PRO

## Filo Luce



20 W/m

24 W/m

5 m			
1 mm			
A			
	A		
	mm	g	mm
100 W	10	123	20
120 W	8	130	15

100 W (20 W/m)	6.300 lm (1.260 lm/m)	300 led/m	CRI 90	3000K	<b>AC90-2030030</b>	10/20	€ 180,00
				4000K	<b>AC90-2030040</b>		
				6000K	<b>AC90-2030060</b>		
120 W (24 W/m)	8.040 lm (1.608 lm/m)	420 led/m	CRI 90	3000K	<b>AC90-2442030</b>	10/20	€ 238,00
				4000K	<b>AC90-2442040</b>		
				6000K	<b>AC90-2442060</b>		

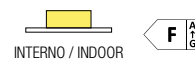

Strip LED professionale per interni, effetto linea di luce continua.

Professional indoor LED strip, uniform light effect.



**3M VHB**  
Extra strong  
Potere dissipante / Dissipation power

Alimentatori e accessori  
Power supplies and accessories  
**PAG. 114-115**



# ACCÈNTO PRO

## Double Row

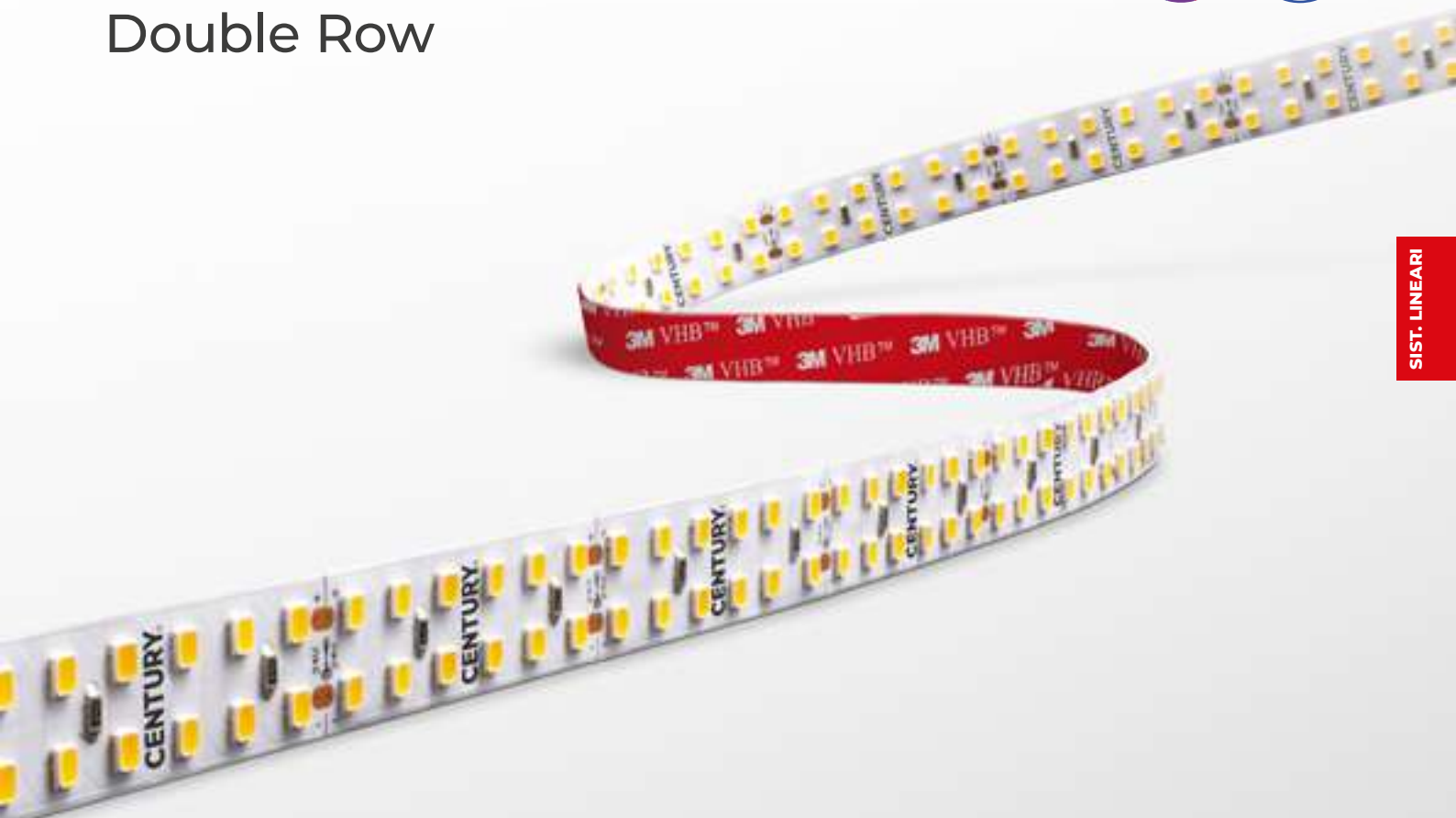

SIST. LINEARI

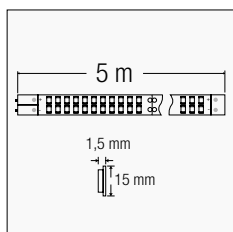

178 g 50 mm

150 W (30 W/m)	11.400 lm (2.280 lm/m)	240 led/m	CRI 90	3000K	<b>AC90-3024030</b>	10/20	€ 146,00
				4000K	<b>AC90-3024040</b>		
				6000K	<b>AC90-3024060</b>		

INTERNO / INDOOR



Strip LED professionale con resa ad altissima luminosità grazie alla doppia fila di chip LED.

High brightness professional LED strip with a double row LED chips.



**3M VHB**  
Extra strong  
Potere dissipante / Dissipation power

Alimentatori e accessori  
Power supplies and accessories  
**PAG. 114-115**

SISTEMI LINEARI - STRIP LED

# ACCÈNTO PRO

## IP67

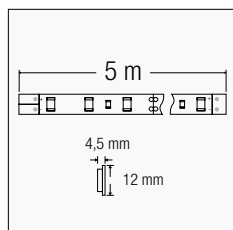

175 g 100 mm

36 W (7,2 W/m)	4.950 lm (990 lm/m)	60 led/m	IP67 - CRI 90	3000K	<b>AC9067-146030</b>	10/20	€ 61,00
				4000K	<b>AC9067-146040</b>		
				6000K	<b>AC9067-146060</b>		

Clip di fissaggio e tappo terminale in silicone inclusi.  
Fixing clip and silicone end cap included.



ESTERNO / OUTDOOR

Strip LED professionale, protetta da polvere e immersioni temporanee.

Professional LED strip, dustproof and water resistant.



Alimentatori, controller e accessori  
Power supplies, controllers and accessories  
PAG. 114-115

NEW

SISTEMI LINEARI - STRIP LED

# ACCÈNTO PRO

## IP65 - RGB+W



SIST. LINEARI

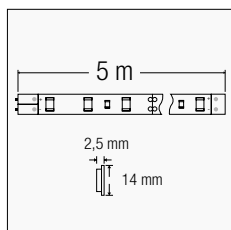

240 g 100 mm

47,5 W (9,5 W/m)	2.280 lm (456 lm/m)	60 led/m	IP65 - CRI 90 (White)	RGB + 3000K	<b>ACRGBW-956030 NEW</b>	10/20	€ 94,00
				RGB + 4000K	<b>ACRGBW-956040 NEW</b>		

Clip di fissaggio e tappo terminale in silicone inclusi.  
Fixing clip and silicone end cap included.



ESTERNO / OUTDOOR



La strip LED RGB+W, a differenza delle RGB, ha chip bianchi dedicati per un bianco puro e colori più vivaci.

The RGB+W LED strip, unlike the RGB, has dedicated white chips for pure white and brighter colors.

Strip LED professionale RGB + White, protetta da polvere e getti d'acqua.

Professional RGB strip + White chip, dustproof and water resistant.



Alimentatori, controller e accessori  
Power supplies, controllers and accessories  
PAG. 114-115



CENTURY

# MAGIC

## IP67 - Color Race RGB

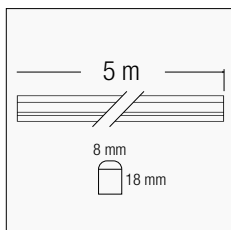

930 g

24 W (4,8 W/m)	-	60 led/m	IP67 - Blister	RGB	<b>MGR5-486010</b>	1/6	€ 79,00
----------------	---	----------	----------------	-----	--------------------	-----	---------



ESTERNO / OUTDOOR



Tecnologia di inseguimento dei colori, ogni chip è programmato singolarmente per un effetto a "cascata".

Color tracking technology, each chip is individually programmed for a "waterfall" effect.

Strip LED professionale RGB + White, protetta da polvere e getti d'acqua. Grazie al telecomando in dotazione è possibile gestire oltre mille giochi di luce dinamici.

RGB + White professional LED strip, dustproof and water resistant. Thanks to the supplied remote control it is possible to get over a thousand dynamic light effects.



Il kit include / The kit includes

MAGIC STRIP  
Telecomando IR / IR Remote  
Alimentatore a spina / Plug-in Power supply  
Clip di fissaggio / Fixing clip



SISTEMI LINEARI - STRIP LED

# ACCÈNTO RGB+W



SIST. LINEARI

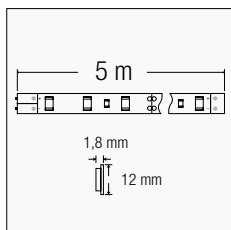

147 g 100 mm

95 W (19 W/m)	5.000 lm (1.000 lm/m)	60 led/m	RGB+White	RGB + 4000K	<b>ACRGBW-196010</b>	10/20	€ 96,00
---------------	-----------------------	----------	-----------	-------------	----------------------	-------	---------

INTERNO / INDOOR



La strip LED RGB+W, a differenza delle RGB, ha chip bianchi dedicati per un bianco puro e colori più vivaci.

The RGB+W LED strip, unlike the RGB, has dedicated white chips for pure white and brighter colors.



**3M VHB**  
Extra strong  
Potere dissipante / Dissipation power

Alimentatori, controller e accessori  
Power supplies, controllers and accessories  
**PAG. 114-115**

Strip LED RGB + White da interno, perfetta per stupire con i colori.

Indoor RGB + White LED Strip, perfect for surprising with colors.



**CENTURY**





# ACCÈNTO **230 V**



Facile installazione  
Easy installation



Collegamento alla rete  
Network connection

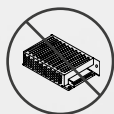

Alimentatore non richiesto  
No power supply required



Senza cali di tensione  
Without voltage drops



Illuminazione uniforme  
Uniform lighting



Taglio ogni 10 cm  
10 cm cuttable

Disponibile in bobine da / Available in reels of  
**5 m - 20 m**

**NEW**

SISTEMI LINEARI - STRIP LED

# ACCÈNTO

## 230 V



SIST. LINEARI

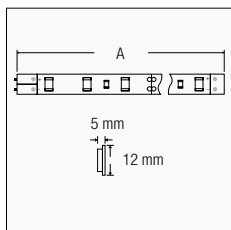

- 340 g / 5 m
- 1450 g / 20 m
- 100 mm

A		PACK							
5 m	70 W (14 W/m)	7.000 lm (1.400 lm/m)	120 led/m	Thermal bag	3000K	<b>AC5230-1512030 NEW</b>	10/20	€ 137,00	
					4000K	<b>AC5230-1512040 NEW</b>			
20 m	280 W (14 W/m)	28.000 lm (1.400 lm/m)	120 led/m	Industry Reel	3000K	<b>AC20230-1512030 NEW</b>	1/4	€ 552,00	
					4000K	<b>AC20230-1512040 NEW</b>			

Clip di fissaggio (10 pz **AC5230** / 40 pz **AC20230**) e tappo terminale in silicone inclusi.  
Fixing clip (10 pz **AC5230** / 40 pz **AC20230**) and silicone end cap included.



### ACCESSORI / ACCESSORIES

KIT START 230 V

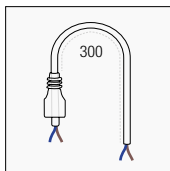

Silicone connector	<b>KIT-STARTAC230 NEW</b>	1/100	€ 4,80
--------------------	---------------------------	-------	--------

FIXING CLIP - 10 pz

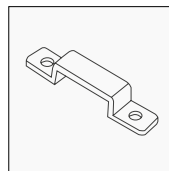

<b>KIT-CLIPAC230 NEW</b>	10/200	€ 2,20
--------------------------	--------	--------

END CAP IP65 - 5 pz

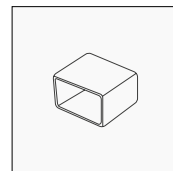

<b>KIT-ENDCAPS NEW</b>	5/100	€ 2,00
------------------------	-------	--------

Strip LED professionale alimentata direttamente a 230 V (No driver), con guaina protettiva in silicone e nastro adesivo 3M. Possibilità di taglio ogni 10 cm.

Professional LED strip powered directly at 230 V (No driver), with protective silicone sheath and 3M adhesive tape. Cutting every 10 cm.





# ACCÈNTO

AC2-722430

AC2-142430



	A	g	mm
24 W	8	305	100
36 W	8	305	165
60 W	10	305	100
62 W	10	305	100
57 W	10	305	100

24 W (4,8 W/m)	2.100 lm (420 lm/m)	30 led/m	6000K	<b>AC2-482460</b>	10/20	€ 10,50
36 W (7,2 W/m)	3.200 lm (640 lm/m)	30 led/m	3000K	<b>AC2-722430</b>	10/20	€ 21,00
			4000K	<b>AC2-722440</b>		
			6000K	<b>AC2-722460</b>		
60 W (12 W/m)	6.250 lm (1.250 lm/m)	60 led/m	3000K	<b>AC2-142430</b>	10/20	€ 29,00
62 W (12,4 W/m)	6.400 lm (1.280 lm/m)	60 led/m	4000K	<b>AC2-142440</b>		
57 W (11,4 W/m)	6.170 lm (1.234 lm/m)	60 led/m	6000K	<b>AC2-142460</b>		

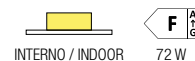

Strip LED da interno, disponibile in diverse potenze e colori luce.

Indoor LED Strip, available in different powers and light colors.



Alimentatori, controller e accessori  
Power supplies, controllers and accessories  
**PAG. 114-115**



# ALIMENTATORI POWER SUPPLY

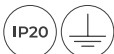
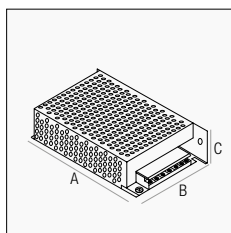

		IN	OUT		A	B	C				
35 W	1500 mA	220-240 V/AC 50/60 Hz	24 V/DC	No Dimm.	88 mm	58 mm	39 mm	131 g	<b>RDAC35-24</b>	1/1	€ 16,00
60 W	2500 mA	220-240 V/AC 50/60 Hz	24 V/DC	No Dimm.	110 mm	77 mm	32 mm	198 g	<b>RDAC60-24</b>	1/1	€ 24,00
100 W	4200 mA	220-240 V/AC 50/60 Hz	24 V/DC	No Dimm.	160 mm	99 mm	43 mm	348 g	<b>RDAC100-24</b>	1/1	€ 29,00
120 W	5000 mA	220-240 V/AC 50/60 Hz	24 V/DC	No Dimm.	160 mm	99 mm	43 mm	430 g	<b>RDAC120-24</b>	1/1	€ 32,00
150 W	6500 mA	220-240 V/AC 50/60 Hz	24 V/DC	No Dimm.	200 mm	99 mm	43 mm	471 g	<b>RDAC150-24</b>	1/1	€ 35,00
200 W	8300 mA	220-240 V/AC 50/60 Hz	24 V/DC	No Dimm.	200 mm	99 mm	43 mm	540 g	<b>RDAC200-24</b>	1/1	€ 43,00

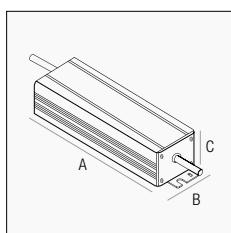

		IN	OUT		A	B	C				
50 W	2100 mA	175-264 V/AC 50/60 Hz	24 V/DC	No Dimm.	205 mm	35 mm	24 mm	530 g	<b>RDAC50-2467</b>	1/1	€ 36,00
60 W	2500 mA	175-264 V/AC 50/60 Hz	24 V/DC	1-10 V	205 mm	35 mm	24 mm	530 g	<b>RDAC60-2467D</b>	1/1	€ 74,00
				No Dimm.	182 mm	62 mm	17 mm	530 g	<b>RDAC100-2467</b>	1/1	€ 62,00
100 W	4200 mA	175-264 V/AC 50/60 Hz	24 V/DC	1-10 V	182 mm	58 mm	32 mm	530 g	<b>RDAC100-2467D</b>	1/1	€ 125,00
				No Dimm.	198 mm	58 mm	32 mm	550g	<b>RDAC150-2467D</b>	1/1	€ 137,00
150 W	6250 mA	175-264 V/AC 50/60 Hz	24 V/DC	1-10 V	198 mm	58 mm	32 mm	550g	<b>RDAC150-2467D</b>	1/1	€ 137,00
200 W	8300 mA	175-264 V/AC 50/60 Hz	24 V/DC	No Dimm.	238 mm	58 mm	32 mm	1100 g	<b>RDAC200-2467</b>	1/1	€ 94,00
250 W	10.500 mA	175-264 V/AC 50/60 Hz	24 V/DC	1-10 V	228 mm	72 mm	32 mm	1300 g	<b>RDAC250-2467D</b>	1/1	€ 170,00
300 W	12.500 mA	175-264 V/AC 50/60 Hz	24 V/DC	No Dimm.	228 mm	72 mm	32 mm	1400 g	<b>RDAC300-2467</b>	1/1	€ 127,00

# CONNETTORI CONNECTORS

LINEARE - 2 pz

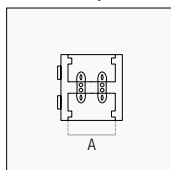

		A				
Plastic Bag	8 mm	<b>ACCN8</b>	1/100	€ 1,20		
	10 mm	<b>ACCN10</b>	1/100	€ 1,80		

T - 2 pz

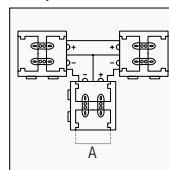

		A				
Plastic Bag	8 mm	<b>ACCN8T</b>	1/100	€ 4,00		
	10 mm	<b>ACCN10T</b>	1/100	€ 4,80		

LINEARE CON CAVO - 2 pz

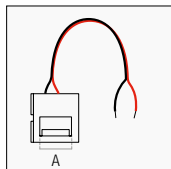

		A				
Plastic Bag	8 mm	<b>ACCN8WIRE</b>	1/100	€ 1,60		
	10 mm	<b>ACCN10WIRE</b>	1/100	€ 1,90		

15 cm

ANGOLARI A L - 2 pz

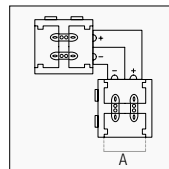

		A				
Plastic Bag	8 mm	<b>ACCN8ANG</b>	1/100	€ 3,10		
	10 mm	<b>ACCN10ANG</b>	1/100	€ 3,60		

LINEARI CON CAVO - 2 pz

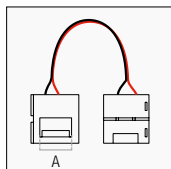

		A				
Plastic Bag	8 mm	<b>ACCN8WIRE2</b>	1/100	€ 2,20		
	10 mm	<b>ACCN10WIRE2</b>	1/100	€ 2,40		

15 cm

X - 2 pz

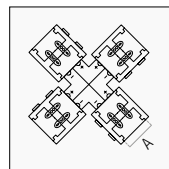

		A				
Plastic Bag	8 mm	<b>ACCN8X</b>	1/100	€ 4,80		
	10 mm	<b>ACCN10X</b>	1/100	€ 5,50		

**NEW**

STRIP LED - SISTEMI DI CONTROLLO

# CONTROLLER



SIST. LINEARI

**TOUCH REMOTE RF**

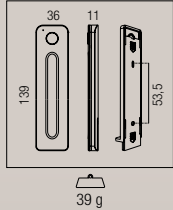

OUT	DISTANCE	BATTERY				
RF (2.4 GHz)	30 m	1x CR2032	Touch Slide 0%-100%	<b>CTLRF NEW</b>	1/100	€ 46,00



Telecomando RF Touch Slide con supporto a parete magnetico.

Radio frequency remote control with magnetic base.

**DIMMER SINGLE COLOR**

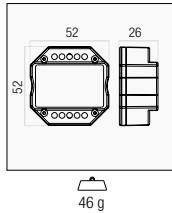

IN V.	OUT V.	OUT			
12-48 V/DC	12-48 V/DC	POWER 192 W / 24 V	Dimm.	<b>DIM-PWM NEW</b>	1/100 € 46,00



**DIM-PWM**

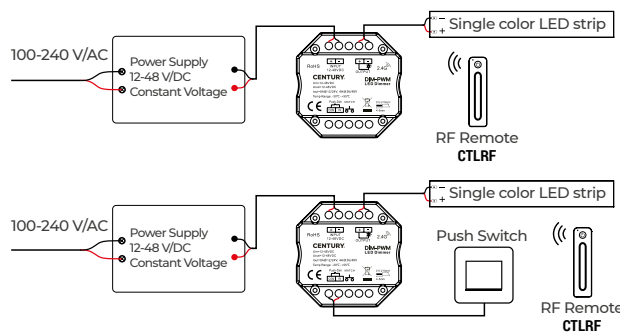

**CONTROLLER RGB+W WI-FI**

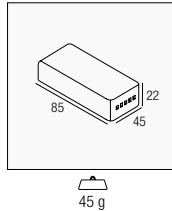

IN / OUT	CARICO MASSIMO / MAX LOAD		
12-24 V/DC	5 A x 4 Channel = 20 A / Max 120 W	Wi-Fi 2,4 GHz	<b>CTL SMA-ACRGBW</b> € 37,00



**KIT CONTROLLER RGB+W + TOUCH REMOTE**

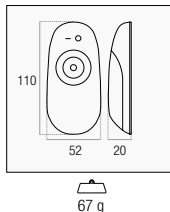
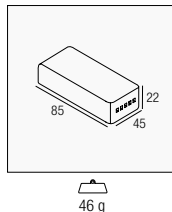

IN / OUT	CARICO MASSIMO / MAX LOAD		
12-24 V/DC	6 A x 4 Channel = 24 A / Max 120 W	Remote RF 2,4 GHz	<b>KIT-ACRGBW</b> € 46,00



**CENTURY**



SISTEMI LINEARI  
SISTEMI LINEARI  
**SISTEMI LINEARI**  
SISTEMI LINEARI  
SISTEMI LINEARI

PROFILI  
PROFILI  
**PROFILI**  
PROFILI  
PROFILI

PROFILES  
PROFILES  
**PROFILES**  
PROFILES  
PROFILES



**NEW**

SISTEMI LINEARI - PROFILI IN ALLUMINIO

# PROFILI E COVER NERI

## BLACK COVERS AND PROFILES



LIGHT OFF



LIGHT ON



Combinando profilo e cover neri è possibile enfatizzare le pareti scure con effetti sorprendenti.

Combining black profile and cover you can emphasize dark walls with amazing effects.

**NEW**

SISTEMI LINEARI - PROFILI IN ALLUMINIO

# PROFILI BIANCHI

## WHITE PROFILES



LIGHT ON  
BIANCO / WHITE



LIGHT ON  
ALUMINUM



SIST. LINEARI



Profili in alluminio disponibili in nuove finiture.  
Cover bianco opale e accessori montaggio inclusi.

Aluminum profiles available in new finishes.  
Opal white cover and installation accessories included.

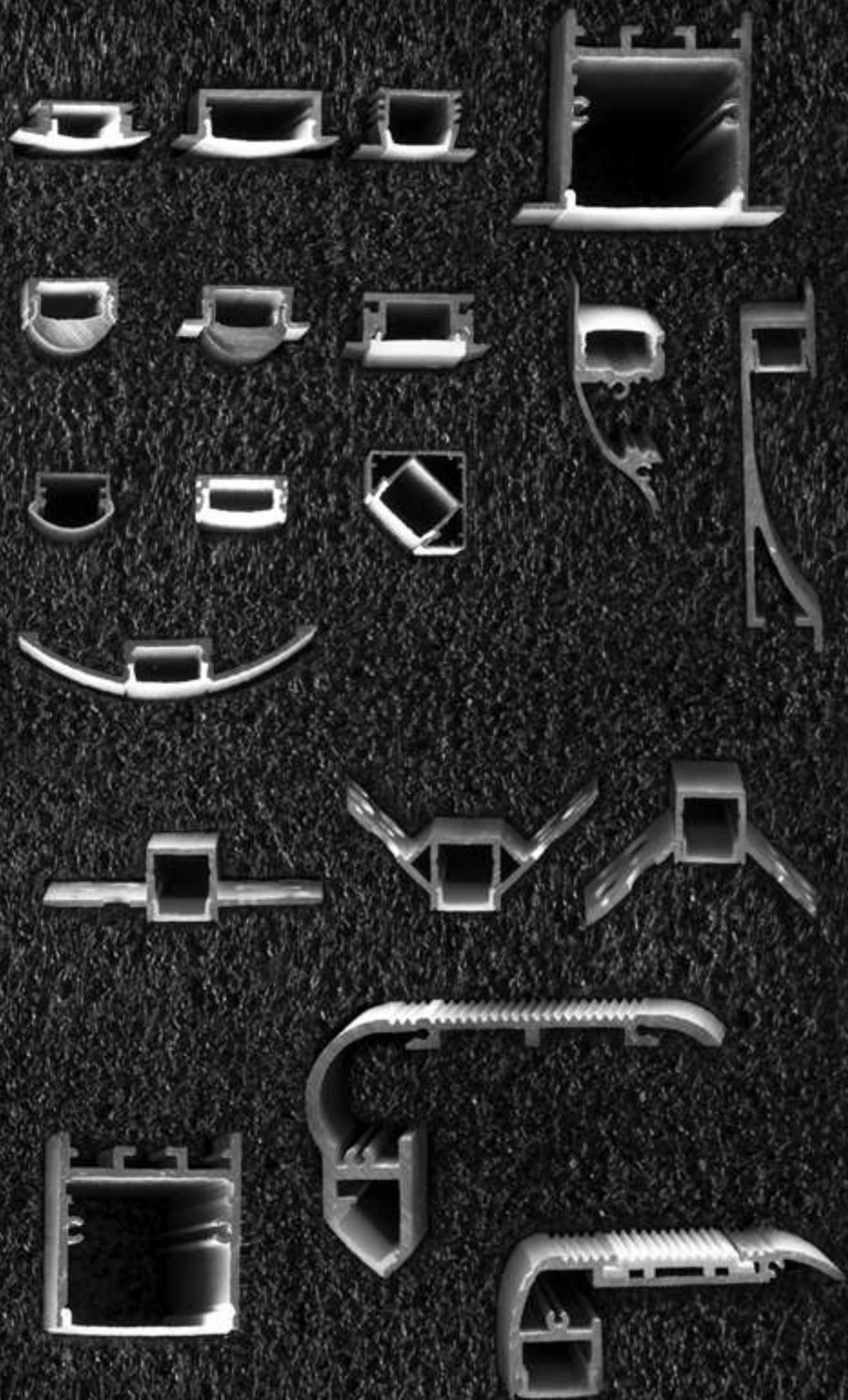

# COMPATIBILITÀ

## COMPATIBILITY

		ACCÈNTO PRO			ACCÈNTO			
		CLASSIC	FILO LUCE	DOUBLE ROW	CLASSIC	RGB+W	230 V	KIT BLISTER
INCASSO/RECESSED	KPRI-2508	✓	✓	-	✓	✓	-	✓
	KPRI-3011	✓	✓	✓	✓	✓	✓	✓
	KPRI-2212	✓	✓	-	✓	-	-	✓
	KPRIC-4736	✓	✓	✓	✓	✓	✓	✓
CARTONGESSO / DRYWALL	KPRCG-5314	✓	✓	-	✓	-	-	✓
	KPRCG-5123	✓	✓	-	✓	-	-	✓
	KPRCG-4626	✓	✓	-	✓	-	-	✓
SUPERFICIE / SURFACE	KPRS-1708	✓	✓	-	✓	-	-	✓
	KPRS-1611	✓	✓	-	✓	✓	-	✓
	KPRSL-5709	✓	✓	-	✓	-	-	✓
	KPRAN-1818	✓	✓	-	✓	-	-	✓
40°	KPRI40G-2413	✓	✓	-	✓	✓	-	✓
	KPRS40G-1713	✓	✓	-	✓	✓	-	✓
SPECIALI / SPECIAL	KPRCA-2711	✓	✓	-	✓	✓	-	✓
	KPRBS-1468	-	-	-	✓	-	-	✓
	KPRVE-4217	✓	✓	-	✓	✓	-	✓
	KPRS-3537	✓	✓	✓	✓	✓	✓	✓
SCALE / STAIRS	KPRSC-6528	✓	✓	-	✓	✓	-	✓
	KPRSC-8050	✓	✓	-	✓	-	-	✓

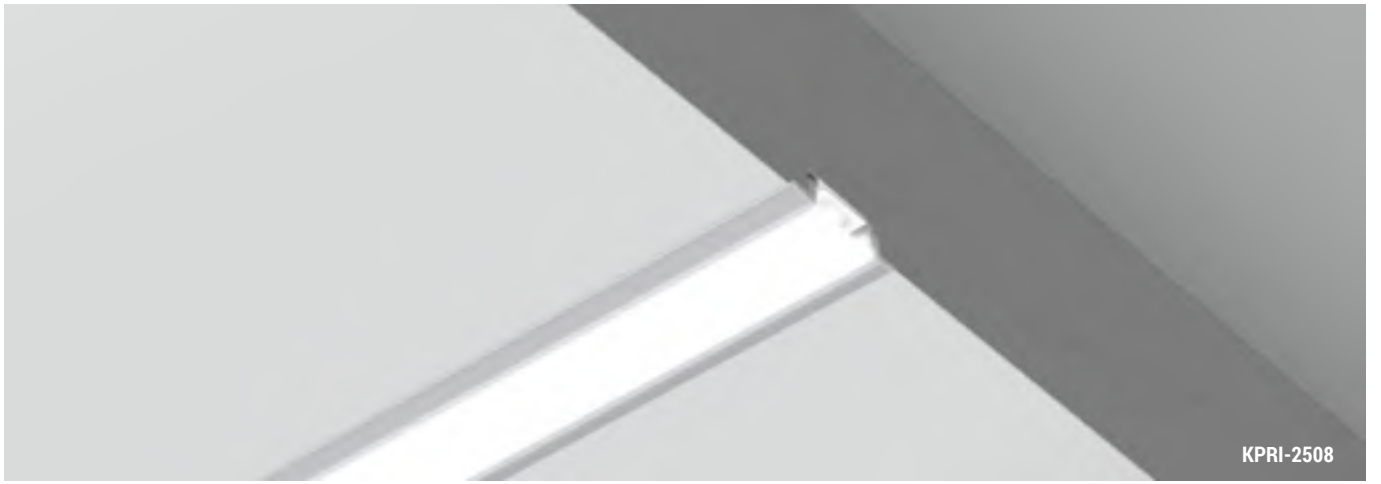

KPRI-2508

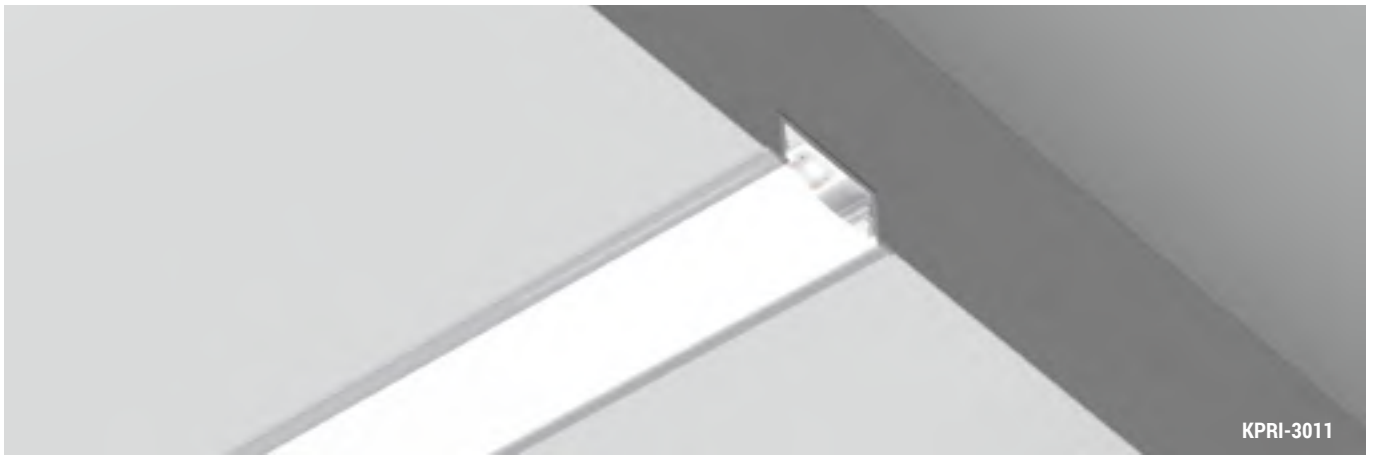

KPRI-3011

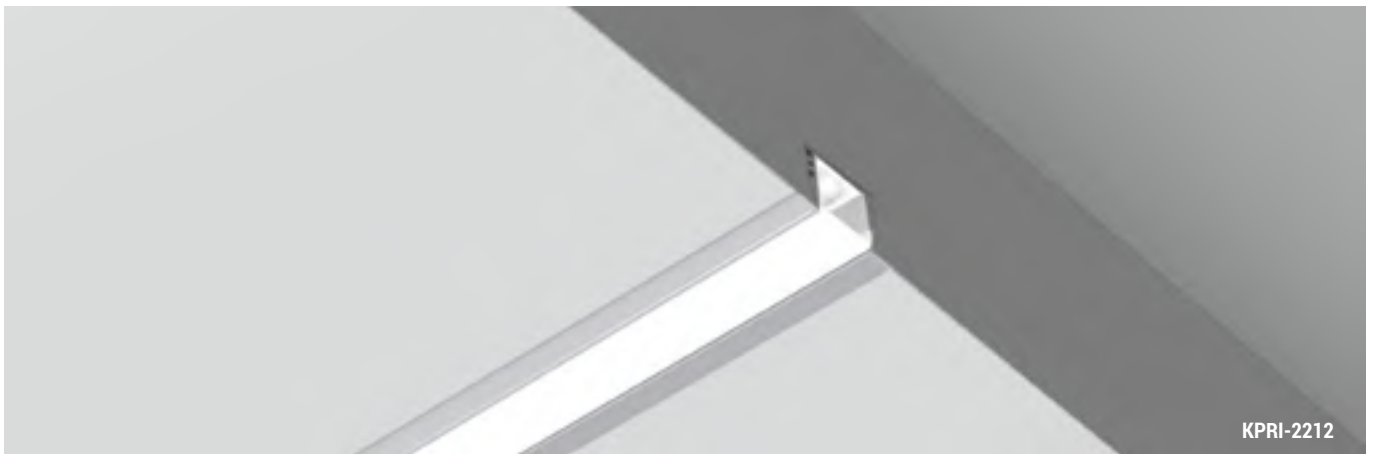

KPRI-2212

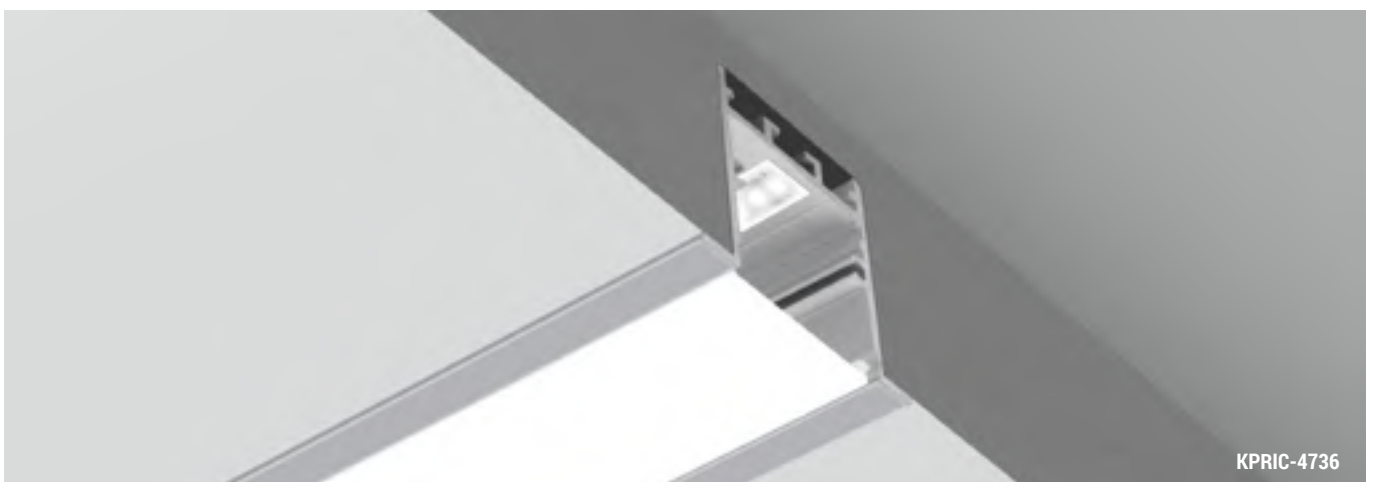

KPRIC-4736

**NEW**

SISTEMI LINEARI - PROFILI IN ALLUMINIO

# INCASSO RECESSED

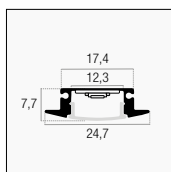

KIT 2 m	Alluminio / Aluminum ○	<b>KPRI-2508</b>	1/20	€ 23,00
	Bianco / White ○	<b>KPRI-2508B NEW</b>	1/20	€ 32,00
	Nero / Black ●	<b>KPRI-2508N NEW</b>		

Comprende cover opale, 2 tappi, 2 tappi con foro e 4 clip  
Includes opal cover, 2 caps, 2 caps with hole and 4 clips

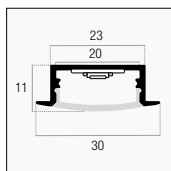

KIT 2 m	Alluminio / Aluminum ○	<b>KPRI-3011</b>	1/20	€ 25,00
---------	------------------------	------------------	------	---------

Comprende cover opale, 2 tappi, 2 tappi con foro  
Includes opal cover, 2 caps, 2 caps with hole

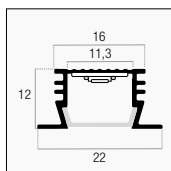

KIT 2 m	Alluminio / Aluminum ○	<b>KPRI-2212</b>	1/20	€ 19,00
---------	------------------------	------------------	------	---------

Comprende cover opale, 2 tappi, 2 tappi con foro  
Includes opal cover, 2 caps, 2 caps with hole

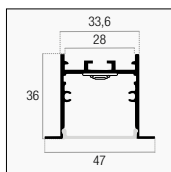

KIT 2 m	Alluminio / Aluminum ○	<b>KPRIC-4736</b>	1/20	€ 113,00
---------	------------------------	-------------------	------	----------

Comprende cover opale, 2 tappi, 1 tappi con foro, 4 molle e 2 piastrine di giunzione.  
Includes opal cover, 2 caps, 1 cap with hole, 4 springs and 2 joint plates.



Profili in alluminio da incasso per strisce LED.  
Cover bianco opale e accessori montaggio inclusi.

Recessed aluminum profiles for LED strips.  
Opal white cover and installation accessories included.

OPZIONALE / OPTIONAL

Cover 1 pz	Nero Opale / Opal Black ●	<b>PRCN-2508N NEW</b>	1/20	€ 13,00
	Trasparente / Transparent ○	<b>PRCV-2508</b>	1/20	€ 4,00
	Opale / Opal ○	<b>PRCO-2508</b>	1/20	€ 5,00
Cap 5 pz	Senza foro / Without hole	<b>KPRI-2508-CAP</b>	5/100	€ 2,20
	Con foro per cavo / With cable hole	<b>KPRI-2508-CAPH</b>		
Clip 10 pz	Fissaggio / Fixing	<b>KPRI-2508-CLIP</b>	10/100	€ 3,90

OPZIONALE / OPTIONAL

Cover 1 pz	Trasparente / Transparent ○	<b>PRCV-3011</b>	1/20	€ 7,00
Cap 5 pz	Senza foro / Without hole	<b>KPRI-3011-CAP</b>	5/100	€ 2,20
	Con foro per cavo / With cable hole	<b>KPRI-3011-CAPH</b>		

OPZIONALE / OPTIONAL

Cover 1 pz	Trasparente / Transparent ○	<b>PRCV-2212</b>	1/20	€ 4,00
Cap 5 pz	Senza foro / Without hole	<b>KPRI-2212-CAP</b>	5/100	€ 2,20
	Con foro per cavo / With cable hole	<b>KPRI-2212-CAPH</b>		

**KPRI-2508-CLIP**



Molle per fissaggio a cartongesso  
Springs for plasterboard fixing

OPZIONALE / OPTIONAL

Molle 10 pz	Per Cartongesso / For Plasterboard	<b>KPRI-2508-CLIP</b>	10/200	€ 26,00
Cap 5 pz	Senza foro / Without hole	<b>KPRIC-4736-CAP</b>	5/500	€ 12,00
	Con foro per cavo / With cable hole	<b>KPRIC-4736-CAPH</b>		

IP20

**KIT**

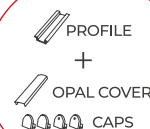

**CENTURY**



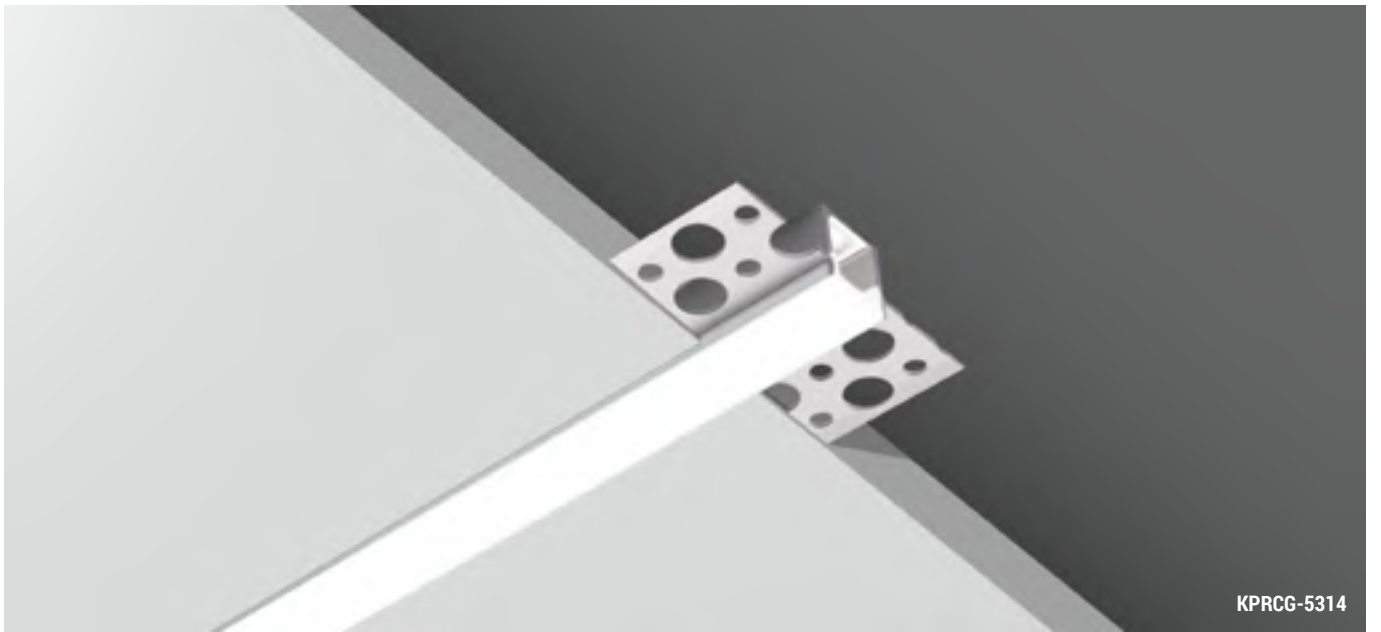

KPRCG-5314



KPRCG-5123



KPRCG-4626



# CARTONGESSO PLASTERBOARD

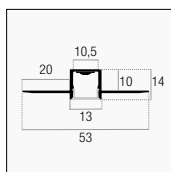

KIT 3 m	Alluminio / Aluminum	<b>KPRCG-5314</b>	5/20	€ 67,00
---------	----------------------	-------------------	------	---------

Comprende cover opale, 3 tappi e 3 tappi con foro  
Includes opal cover, 3 caps and 3 caps with hole

### OPZIONALE / OPTIONAL

Cover	1 pz	Opale / Opal	<b>KPRCG-5314</b>	1/12	€ 8,00
Cap	5 pz	Senza foro / Without hole	<b>KPRCG-5314-CAP</b>	5/100	€ 2,60
		Con foro per cavo / With cable hole	<b>KPRCG-5314-CAPH</b>		

### ANGOLARE ESTERNO / EXTERNAL CORNER

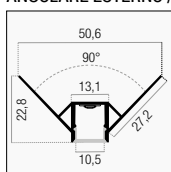

KIT 3 m	Alluminio / Aluminum	<b>KPRCG-5123</b>	5/20	€ 72,00
---------	----------------------	-------------------	------	---------

Comprende cover opale, 2 tappi e 1 tappi con foro  
Includes opal cover, 2 caps and 1 caps with hole

### OPZIONALE / OPTIONAL

Cap	5 pz	Senza foro / Without hole	<b>KPRCG-5123-CAP</b>	5/100	€ 2,60
		Con foro per cavo / With cable hole	<b>KPRCG-5123-CAPH</b>		

### ANGOLARE INTERNO / INTERNAL CORNER

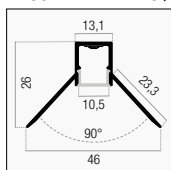

KIT 3 m	Alluminio / Aluminum	<b>KPRCG-4626</b>	5/20	€ 72,00
---------	----------------------	-------------------	------	---------

Comprende cover opale, 2 tappi e 1 tappi con foro  
Includes opal cover, 2 caps and 1 caps with hole

### OPZIONALE / OPTIONAL

Cap	5 pz	Senza foro / Without hole	<b>KPRCG-4626-CAP</b>	5/100	€ 2,60
		Con foro per cavo / With cable hole	<b>KPRCG-4626-CAPH</b>		



Packaging protettivo tubolare.  
Protective tubular packaging.

Profili in alluminio per strisce LED per installazioni a scomparsa su cartongesso.

Aluminum profiles for LED strips for installations concealed on plasterboard.

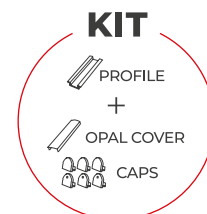



KPRS-1708



KPRS-1611



KPRSL-5709



KPRAN-1818

**NEW**

SISTEMI LINEARI - PROFILI IN ALLUMINIO

# SUPERFICIE SURFACE

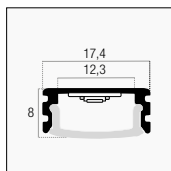

KIT 2 m	Alluminio / Aluminum ○	<b>KPRS-1708</b>	1/20	€ 22,00
	Bianco / White ○	<b>KPRS-1708B NEW</b>	1/20	€ 29,00
	Nero / Black ●	<b>KPRS-1708N NEW</b>		

Comprende cover opale, 2 tappi, 2 tappi con foro e 4 clip  
Includes opal cover, 2 caps, 2 caps with hole and 4 clips

### BOMBATA / ROUNDED

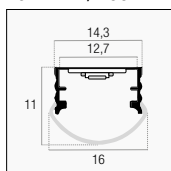

KIT 2 m	Alluminio / Aluminum ○	<b>KPRS-1611</b>	1/20	€ 15,00
	Bianco / White ○	<b>KPRS-1611B NEW</b>	1/20	€ 20,00
	Nero / Black ●	<b>KPRS-1611N NEW</b>		

Comprende cover opale, 2 tappi, 2 tappi con foro e 4 clip  
Includes opal cover, 2 caps, 2 caps with hole and 4 clips

### ULTRAPIATTA / ULTRA-FLAT

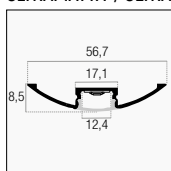

KIT 2 m	Alluminio / Aluminum ○	<b>KPRSL-5709</b>	1/20	€ 35,00
---------	------------------------	-------------------	------	---------

Comprende cover opale, 2 tappi, 2 tappi con foro e 4 clip  
Includes opal cover, 2 caps, 2 caps with hole and 4 clips

### ANGOLARE / ANGULAR

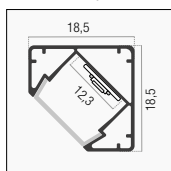

KIT 2 m	Alluminio / Aluminum ○	<b>KPRAN-1818</b>	1/20	€ 20,00
	Bianco / White ○	<b>KPRAN-1818B NEW</b>	1/20	€ 36,00
	Nero / Black ●	<b>KPRAN-1818N NEW</b>		

Comprende cover opale, 2 tappi, 2 tappi con foro e 4 clip  
Includes opal cover, 2 caps, 2 caps with hole and 4 clips

### OPZIONALE / OPTIONAL

Cover 1 pz	Nero Opale / Opal Black ●	<b>PRCN-1708N NEW</b>	1/20	€ 13,00
	Trasparente / Transparent ○	<b>PRCV-1708</b>	1/20	€ 4,50
	Opale / Opal ○	<b>PRCO-1708</b>	1/20	€ 6,00
Cap 5 pz	Senza foro / Without hole	<b>KPRS-1708-CAP</b>	5/100	€ 2,20
	Con foro per cavo / With cable hole	<b>KPRS-1708-CAPH</b>		
Clip 10 pz	Fissaggio / Fixing	<b>KPRS-1708-CLIP</b>	10/100	€ 3,90

### OPZIONALE / OPTIONAL

Cover 1 pz	Nero Opale / Opal Black ●	<b>PRCN-1611N NEW</b>	1/20	€ 11,00
	Opale / Opal ○	<b>PRCO-1611</b>	1/20	€ 5,00
Cap 5 pz	Senza foro / Without hole	<b>KPRS-1611-CAP</b>	5/100	€ 2,20
	Con foro per cavo / With cable hole	<b>KPRS-1611-CAPH</b>		
Clip 10 pz	Fissaggio / Fixing	<b>KPRS-1611-CLIP</b>	10/100	€ 3,90

### OPZIONALE / OPTIONAL

Cap 5 pz	Senza foro / Without hole	<b>KPRSL-5709-CAP</b>	5/100	€ 3,40
	Con foro per cavo / With cable hole	<b>KPRSL-5709-CAPH</b>		
Clip 10 pz	Fissaggio / Fixing	<b>KPRSL-5709-CLIP</b>	10/100	€ 16,00

### OPZIONALE / OPTIONAL

Cover 1 pz	Nero Opale / Opal Black ●	<b>PRCN-1818N NEW</b>	1/20	€ 12,00
	Trasparente / Transparent ○	<b>PRCV-1818</b>	1/20	€ 4,50
	Opale / Opal ○	<b>PRCO-1818</b>	1/20	€ 5,00
Cap 5 pz	Senza foro / Without hole	<b>KPRAN-1818-CAP</b>	5/100	€ 2,40
	Con foro per cavo / With cable hole	<b>KPRAN-1818-CAPH</b>		
Clip 10 pz	Fissaggio / Fixing	<b>KPRAN-1818-CLIP</b>	10/100	€ 3,90

Profili in alluminio per strisce LED per installazioni a superficie.

Aluminum profiles for LED strips for surface installations.

IP20

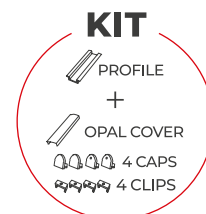

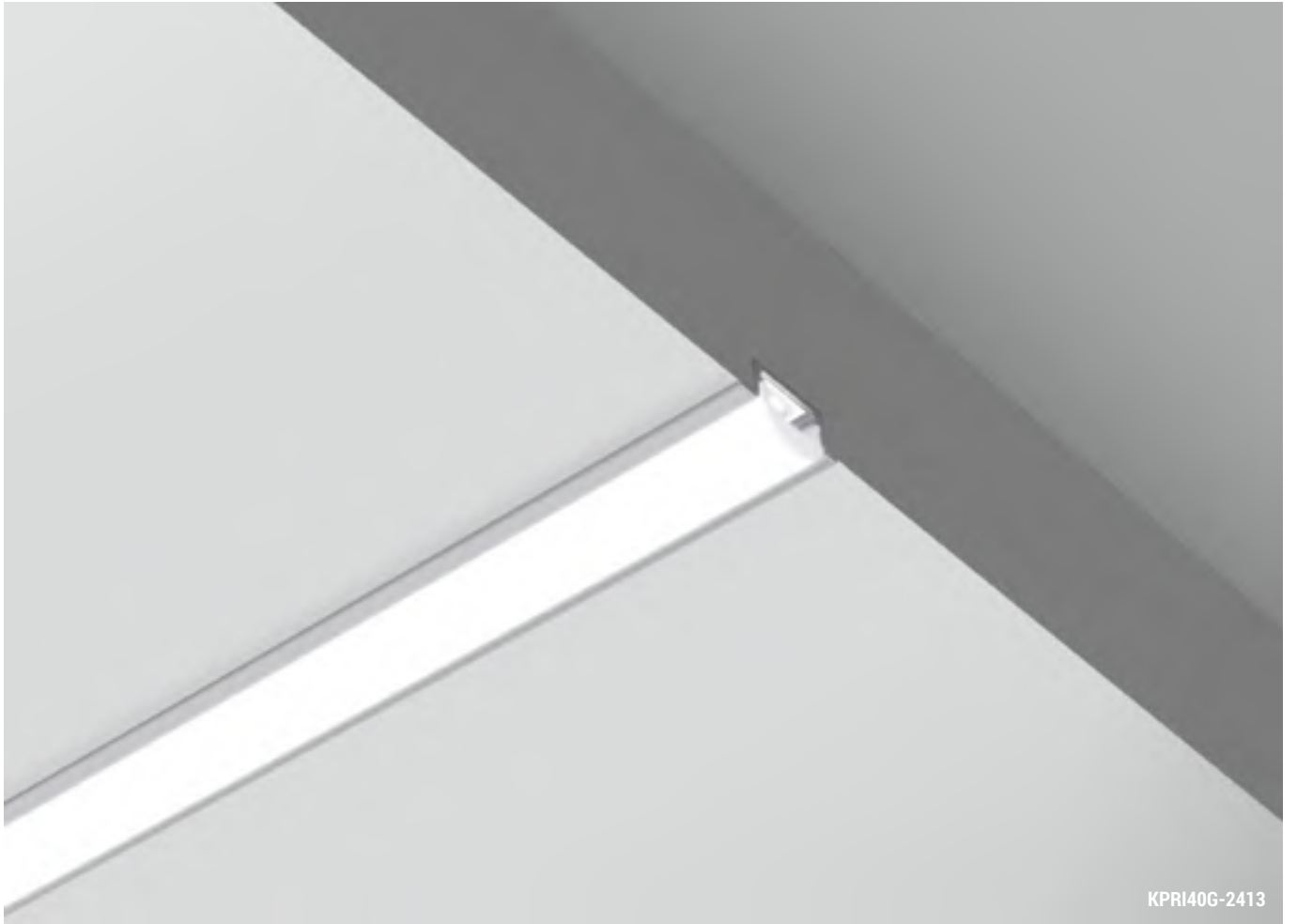

KPRI40G-2413



KPRI40G-1713

**INCASSO / RECESSED**

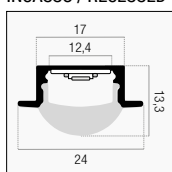

KIT 2 m	Alluminio / Aluminum	<b>KPRI40G-2413</b>	1/20	€ 30,00
---------	----------------------	---------------------	------	---------

Comprende cover opale, 2 tappi e 1 tappo con foro  
Includes opal cover, 2 caps and 1 cap with hole

**OPZIONALE / OPTIONAL**

Cap	5 pz	Senza foro / Without hole	<b>KPRI40G-2413-CAP</b>	5/100	€ 2,40
		Con foro per cavo / With cable hole	<b>KPRI40G-2413-CAPH</b>		

**SUPERFICIE / SURFACE**

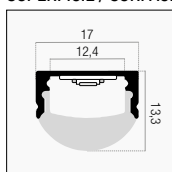

KIT 2 m	Alluminio / Aluminum	<b>KPRS40G-1713</b>	1/20	€ 26,00
---------	----------------------	---------------------	------	---------

Comprende cover opale, 2 tappi, 1 tappo con foro e 4 clips  
Includes opal cover, 2 caps, 1 cap with hole and 4 clips

**OPZIONALE / OPTIONAL**

Cap	5 pz	Senza foro / Without hole	<b>KPRS40G-1713-CAP</b>	5/100	€ 2,40
		Con foro per cavo / With cable hole	<b>KPRS40G-1713-CAPH</b>		
Clip	10 pz	Fissaggio / Fixing	<b>KPRS40G-1713-CLIP</b>	10/100	€ 4,80

Ideale per Wallwasher  
Suitable for Wallwasher

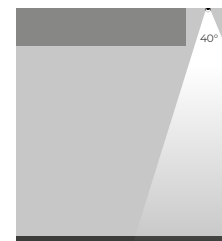
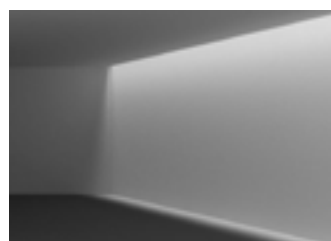

Profili in alluminio per strisce LED. La speciale cover concentra la luce in un fascio ristretto permettendogli di raggiungere una maggiore distanza.

Aluminum profiles for LED strips.  
The special cover concentrates the light in one beam narrow allowing it to reach a greater distance.

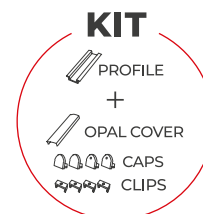



KPRCA-2711

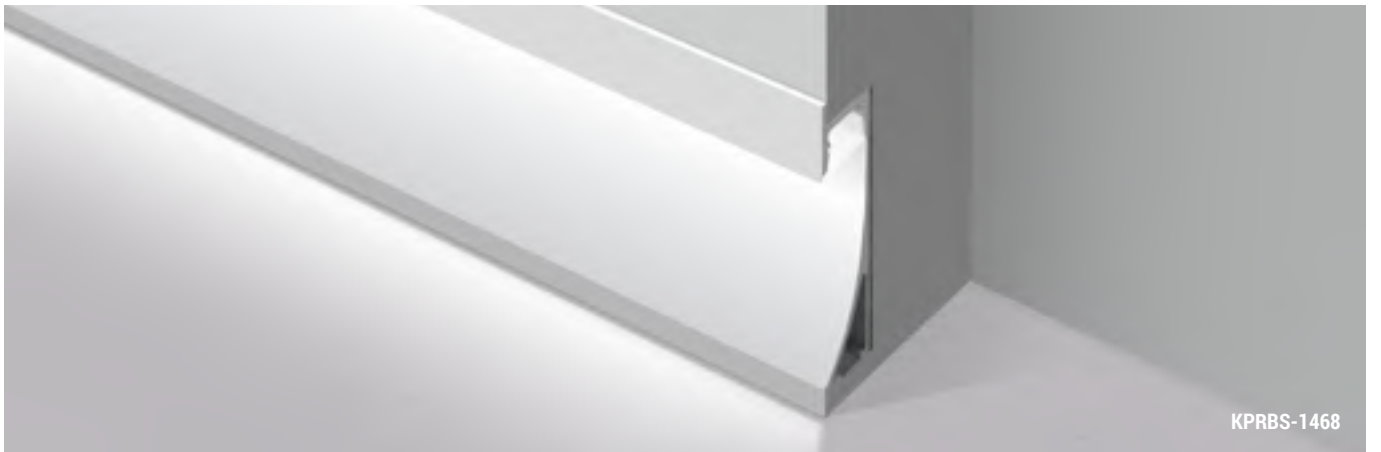

KPRBS-1468

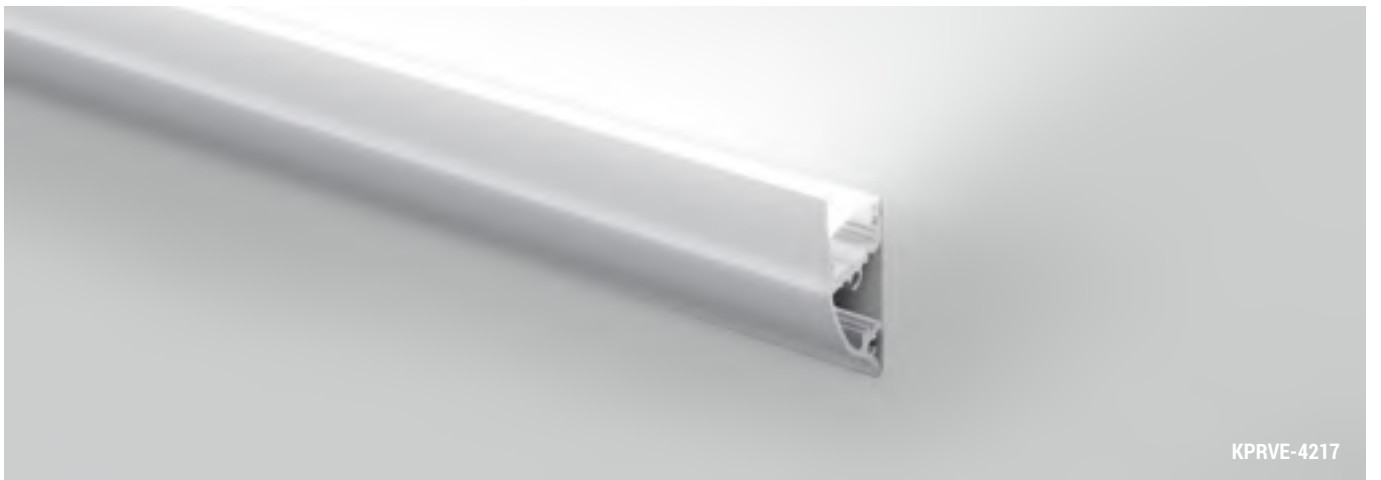

KPRVE-4217



KPRS-3537

**NEW**

SISTEMI LINEARI - PROFILI IN ALLUMINIO

# SPECIALI SPECIAL

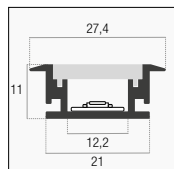
**CALPESTABILE / WALKABLE**

KIT 2 m	Alluminio / Aluminum	<b>KPRCA-2711</b>	1/20	€ 35,00
---------	----------------------	-------------------	------	---------

Comprende cover opale, 2 tappi e 2 tappi con foro  
Includes opal cover, 2 caps and 2 caps with hole

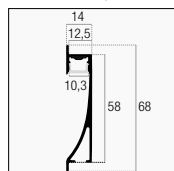
**BATTISCOPA / SKIRTING**

KIT 2 m	Alluminio / Aluminum	<b>KPRBS-1468</b>	1/20	€ 113,00
---------	----------------------	-------------------	------	----------

Comprende cover opale, 2 tappi e 1 tappo con foro  
Includes opal cover, 2 caps and 1 cap with hole

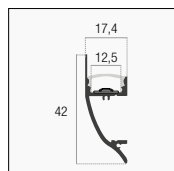
**VELA**

KIT 2 m	Alluminio / Aluminum	<b>KPRVE-4217</b>	1/10	€ 44,00
---------	----------------------	-------------------	------	---------

Comprende cover opale, 2 tappi, 1 tappo con foro e 4 clips  
Includes opal cover, 2 caps, 1 cap with hole and 4 clips

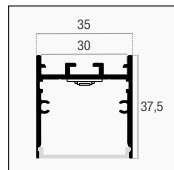
**SOSPENSIONE / SUSPENSION**

KIT 2 m	Alluminio / Aluminum	<b>KPRS-3537</b>	1/6	€ 113,00
	Bianco / White	<b>KPRS-3537B NEW</b>	1/6	€ 125,00

Comprende cover opale, kit sospensione, 2 tappi, 1 tappo con foro, 4 clip e 2 piastrelle di giunzione.  
Includes opal cover, suspension kit, 2 caps, 1 cap with hole, 4 clips and 2 joint plates.



Profili in alluminio per strisce LED per installazioni speciali.

Aluminum profiles for LED strips for special installations.

**OPZIONALE / OPTIONAL**

Cap 5 pz	Senza foro / Without hole	<b>KPRCA-2711-CAP</b>	5/100	€ 5,80
	Con foro per cavo / With cable hole	<b>KPRCA-2711-CAPH</b>		

**OPZIONALE / OPTIONAL**

Cap 5 pz	Senza foro / Without hole	<b>KPRBS-1468-CAP</b>	5/100	€ 7,50
	Con foro per cavo / With cable hole	<b>KPRBS-1468-CAPH</b>		

**OPZIONALE / OPTIONAL**

Cap 5 pz	Senza foro / Without hole	<b>KPRVE-4217-CAP</b>	5/100	€ 9,00
	Con foro per cavo / With cable hole	<b>KPRVE-4217-CAPH</b>		
Clip 10 pz	Fissaggio / Fixing	<b>KPRVE-4217-CLIP</b>	10/100	€ 16,00

**OPZIONALE / OPTIONAL**

Cover 1 pz	Opale / Opal	<b>PRCO-3537 NEW</b>	1/20	€ 17,00
Cap 5 pz	Senza foro / Without hole	<b>KPRS-3537-CAP</b>	5/100	€ 12,00
	Con foro per cavo / With cable hole	<b>KPRS-3537-CAPH</b>		
Clip 10 pz	Fissaggio / Fixing	<b>KPRS-3537-CLIP</b>	10/100	€ 16,00

IP20

**KIT**





KPRSC-6528



KPRSC-8050

# SCALE STAIRS



## LUCE PERPENDICOLARE / PERPENDICULAR LIGHT

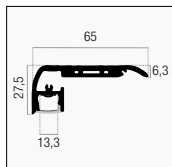

KIT 1,5 m	Alluminio / Aluminum	<b>KPRSC-6528</b>	5/20	€ 67,00
-----------	----------------------	-------------------	------	---------

Comprende cover opale e 2 tappi  
Includes opal cover and 2 caps

### OPZIONALE / OPTIONAL

Cap 5 pz	Senza foro / Without hole	<b>KPRSC-6528-CAP</b>	5/100	€ 4,50
	Con foro per cavo / With cable hole	<b>KPRSC-6528-CAPH</b>		

## LUCE OBLIQUA / OBLIQUE LIGHT

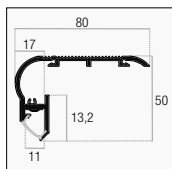

KIT 1,5 m	Alluminio / Aluminum	<b>KPRSC-8050</b>	5/20	€ 84,00
-----------	----------------------	-------------------	------	---------

Comprende cover opale e 2 tappi  
Includes opal cover and 2 caps

### OPZIONALE / OPTIONAL

Cap 5 pz	Senza foro / Without hole	<b>KPRSC-8050-CAP</b>	5/100	€ 4,50
	Con foro per cavo / With cable hole	<b>KPRSC-8050-CAPH</b>		

SIST. LINEARI



Scanalature antiscivolo.  
Anti-slip grooves.

Profili in alluminio per strisce LED per installazioni su scale.

Aluminum profiles for LED strips for installations on stairs.

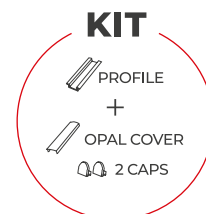



SISTEMI LINEARI  
SISTEMI LINEARI  
**SISTEMI LINEARI**  
SISTEMI LINEARI  
SISTEMI LINEARI

PLAFONIERE  
PLAFONIERE  
**PLAFONIERE**  
PLAFONIERE  
PLAFONIERE

CEILING LIGHTS  
CEILING LIGHTS  
**CEILING LIGHTS**  
CEILING LIGHTS  
CEILING LIGHTS

# SPEEDY



	A	g
4 W	313	68
8 W	573	106
10 W	873	142
14 W	1173	186
18 W	1478	217

		OUTPUT			
4 W	400 lm	3000K	<b>SPD-043030</b>	6/24	€ 13,00
		4000K	<b>SPD-043040</b>		
8 W	800 lm	3000K	<b>SPD-086030</b>	6/24	€ 17,00
		4000K	<b>SPD-086040</b>		
10 W	1.000 lm	3000K	<b>SPD-109030</b>	6/24	€ 20,00
		4000K	<b>SPD-109040</b>		
14 W	1.400 lm	3000K	<b>SPD-141230</b>	6/24	€ 23,00
		4000K	<b>SPD-141240</b>		
18 W	1.850 lm	4000K	<b>SPD-181540</b>	6/24	€ 35,00



Collegabile in serie  
Linkable in series

4 W Max 25 pz  
8 W Max 12 pz  
10 W Max 10 pz  
14 W Max 7 pz  
18 W Max 5 pz



Cavetto di raccordo flessibile opzionale  
Optional flexible connection cable

<b>RC-SPD</b>	6/100	€ 4,00
---------------	-------	--------

Plafoniera innestabile l'una nell'altra a filo continuo.  
Luce funzionale di alta qualità.

Linkable ceiling light.  
Functional high quality fixture.





**NEW**





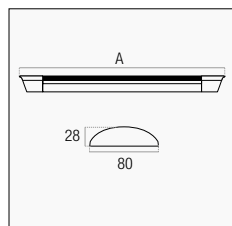





SISTEMI LINEARI - PLAFONIERE

# STABILA

SIST. LINEARI



	A mm	 g
18 W	600	367
36 W	1200	578
45 W	1500	783
60 W	1500	783

	SOURCE			OUTPUT		
	Power	Beam Diameter	Beam Length	Color Temp	Model	Price
19 W	2.100 lm	1.980 lm	3000K		<b>STB-186030</b>	1/6  € 31,00
	2.090 lm	1.980 lm	4000K		<b>STB-186040</b>	
36 W	4.040 lm	3.960 lm	3000K		<b>STB-361230</b>	1/6  € 50,00
	4.220 lm	3.960 lm	4000K		<b>STB-361240</b>	
45 W	5.030 lm	4.950 lm	3000K		<b>STB-451530</b>	1/6  € 64,00
	5.050 lm	4.950 lm	4000K		<b>STB-451540</b>	
60 W	7.290 lm	7.000 lm	4000K		<b>STB-601540 NEW</b>	1/6  € 79,00



Kit installazione a soffitto o a parete incluso  
Ceiling or wall installation kit included



Kit installazione a sospensione opzionale  
Optional suspended installation kit

<b>KIT-PQ40</b>	1/100 	€ 11,00
-----------------	---	---------

Di facile installazione, kit fissaggio incluso.  
Corpo in alluminio ad alta dissipazione.

Easy installation, fixing kit included.  
High dissipation aluminum body.





Prismatizzato  
Prismatic



LNK

LNK16BI



Dark Light

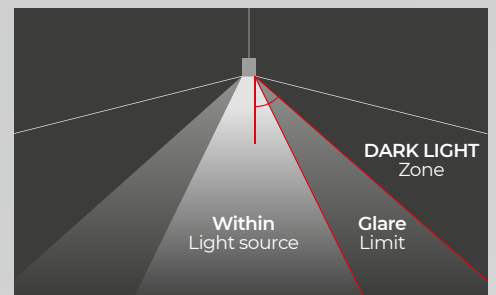

Un apparecchio può essere classificato come Dark Light solo quando soddisfa i requisiti per il limite di buio, ovvero devono esserci meno di 200 cd/lm<sup>2</sup> sopra l'angolo di visione di 60°.

A luminaire can only be classified as Dark Light when it meets the requirements for the dark limit, ie there must be less than 200 cd / lm<sup>2</sup> above the 60 ° viewing angle.



### PRISMATIZZATO

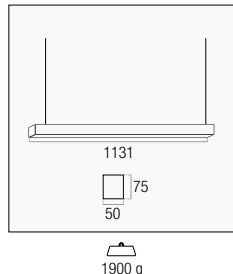

	SOURCE	OUTPUT						
32 W	4.500 lm	3.200 lm	Prismatic diffuser	Alluminio / Aluminum	4000K	<b>LNK-321240</b>	1/10	€ 120,00

### DARK LIGHT

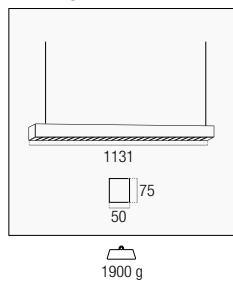

	SOURCE	OUTPUT						
32 W	4.000 lm	3.520 lm	Dark light diffuser - UGR < 16	Alluminio / Aluminum	4000K	<b>LNK16-321240</b>	1/10	€ 149,00
				Bianco / White	4000K	<b>LNK16BI-321240</b>		



### Esempi di installazione / Installation examples



### RACCORDO OPZIONALE / OPTIONAL CONNECTION

	Lineare / Linear	Grigio / Grey	<b>LNKCNL</b>	1/200	€ 6,70
	Snodato 2 vie / 2-way articulated	Grigio / Grey	<b>LNKCN2</b>	1/120	€ 9,00
Bianco / White		<b>LNKCN2BI</b>	1/100	€ 9,00	
	Snodato 4 vie / 4-way articulated	Grigio / Grey	<b>LNKCN4</b>	1/70	€ 12,00
		Bianco / White	<b>LNKCN4BI</b>	1/100	€ 12,00



Plafoniere da interno linkabili con raccordi di giunzione opzionali. Struttura in alluminio con parabole in PC.

Indoor ceiling lights linkable with optional junction connection. Aluminum structure with PC parables.

Installazione a soffitto o a sospensione tramite kit sospensione (1,5 m) / superficie incluso

Ceiling or suspended installation using suspension kit (1.5 m) / surface included



SISTEMI LINEARI  
SISTEMI LINEARI  
**SISTEMI LINEARI**  
SISTEMI LINEARI  
SISTEMI LINEARI

PLAFONIERE STAGNE  
PLAFONIERE STAGNE  
**PLAFONIERE STAGNE**  
PLAFONIERE STAGNE  
PLAFONIERE STAGNE

WATERTIGHT CEILING LIGHTS  
WATERTIGHT CEILING LIGHTS  
**WATERTIGHT CEILING LIGHTS**  
WATERTIGHT CEILING LIGHTS  
WATERTIGHT CEILING LIGHTS

# SUPERLIGHT

SIST. LINEARI



Rapida installazione, design lineare compatto.  
Quick installation, compact linear design.

A		
	A mm	 g
18 W	625	180
24 W	1200	300
36 W	1525	400

	SOURCE		OUTPUT				
18 W	1.900 lm	1.800 lm	4000K		<b>SPL65-186040</b>	1/25	€ 18,00
24 W	2.500 lm	2.400 lm	4000K		<b>SPL65-241240</b>	1/25	€ 23,00
36 W	3.800 lm	3.600 lm	4000K		<b>SPL65-361540</b>	1/25	€ 34,00

Staffe per fissaggio incluse  
Fixing brackets included

Plafoniera IP65 con LED integrato dal design compatto, ideale per ambienti interni ed esterni.

Compact design IP65 ceiling light with integrated LED, for indoor and outdoor ambience.







Box di alimentazione  
Supply box

# SUPREMA-RV

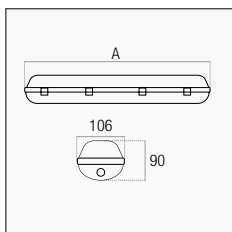

Plafoniera stagna vuota per tubi LED T8.  
Empty watertight ceiling light for T8 LED tubes.



A					
1263 mm	1220 g	<b>SPPRV-361200</b>	1/10 	€ 25,00	
1564 mm	1650 g	<b>SPPRV-481500</b>	1/6 	€ 34,00	

Predisposizione per connessione in serie  
Suitable for series connection

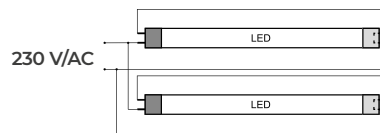

Cablaggio doppio tubo interno.  
Internal double tube wiring.



Include / Includes

Accessori di fissaggio  
Passacavo in plastica

Fixing accessories  
Plastic cable gland

Plafoniera stagna per tubi Led T8 con alimentazione da singolo lato, cablaggio con possibilità di derivazione linea interna.

Watertight ceiling light for T8 Led tubes with single-ended power supply, internal line derivation wiring optional.

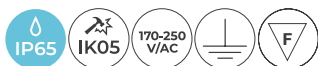



# SUPREMA-R



Plafoniera stagna con tubi LED sostituibili inclusi.  
Watertight ceiling light with replaceable LED tubes included.

	A mm	B mm	g
9 W	665	66	630
18 W	1263	66	1200
36 W	1263	106	1860
48 W	1564	106	2400

OUTPUT

9 W	900 lm	4000K		<b>SPPR-106040</b>	1/10	€ 23,00
18 W	1.800 lm	4000K		<b>SPPR-181240</b>	1/10	€ 32,00
36 W	3.600 lm	4000K		<b>SPPR-361240</b>	1/10	€ 47,00
48 W	4.400 lm	4000K		<b>SPPR-481540</b>	1/6	€ 55,00

Predisposizione per connessione in serie  
Suitable for series connection

Cablaggio con possibilità di derivazione linea interna, ottima come sostituzione delle plafoniere stagne tradizionali.

Internal line derivation wiring optional.  
Suitable for relamping of the traditional watertight ceiling lights.

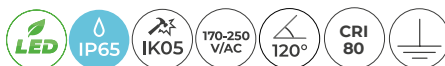

Include / Includes

Accessori di fissaggio  
Passacavo in plastica

Fixing accessories  
Plastic cable gland



Emerg.  
**EMERG.**  
**3h**  
ITLRE

Dimm.  
**DALI 2**  
ITLRD

# ITALIA **ROUND**



LED integrato  
Integrated LED



Ampio dissipatore in alluminio  
Large aluminum heatsink



Stagna  
Watertight



Robusta  
Sturdy

Disponibile nelle versioni / Available in versions  
**Standard • 3h Emergenza / Emergency • DALI-2**

# ITALIA ROUND

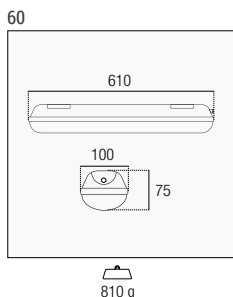

SOURCE		OUTPUT					
18 W	1.880 lm	1.650 lm	Standard	4000K	<b>ITLR-186040</b>	1/6	€ 42,00

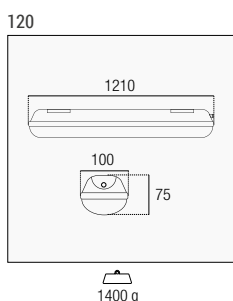

SOURCE		OUTPUT					
36 W	4.780 lm	3.960 lm	Standard	4000K	<b>ITLR-361240</b>	1/6	€ 62,00
				6500K	<b>ITLR-361265</b>		
			Dimm. DALI-2	4000K	<b>ITLRD-361240</b>	1/6	€ 101,00
40 W	5.300 lm	4.200 lm	3h Emerg.	4000K	<b>ITLRE-401240</b>	1/6	€ 156,00

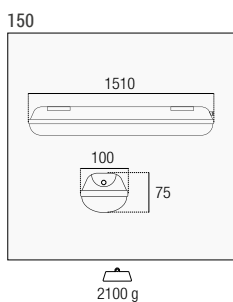

SOURCE		OUTPUT					
40 W	4.790 lm	4.200 lm	3h Emerg.	4000K	<b>ITLRE-401540</b>	1/6	€ 166,00
48 W	6.240 lm	5.280 lm	Standard	4000K	<b>ITLR-481540</b>	1/6	€ 84,00
	5.130 lm	4.500 lm	Standard	6500K	<b>ITLR-481565</b>		
	5.470 lm	4.800 lm	Dimm. DALI-2	4000K	<b>ITLRD-481540</b>	1/6	€ 120,00
60 W	7.530 lm	6.600 lm	Standard	4000K	<b>ITLR-601540</b>	1/6	€ 91,00
	6.840 lm	6.000 lm	Dimm. DALI-2	4000K	<b>ITLRD-601540</b>	1/6	€ 130,00
			3h Emerg.	4000K	<b>ITLRE-601540</b>	1/6	€ 182,00



Ricambio kit emergenza opzionale  
Optional spare emergency kit

<b>Cod. RKITLER</b>	1/6	€ 106,00
---------------------	-----	----------



Include / Includes

Accessori di fissaggio  
2 Passacavi in plastica per connessione in serie

Fixing accessories  
2 Plastic cable glands for series connection

Plafoniera stagna con corpo in policarbonato ad alta resistenza meccanica.

Watertight ceiling light with strength high mechanical polycarbonate body.







SOSPENSIONI INDUSTRIALI

INDUSTRIAL SUSPENSIONS



# EXTREMA 150

Disponibile nelle versioni / Available in versions  
1-10 V • DALI-2



EXTR



EXTRDL



Stagna  
Watertight



Robusta  
Sturdy



Senza cali di tensione  
Without voltage drops

# EXTREMA 150

## Dimmerabile

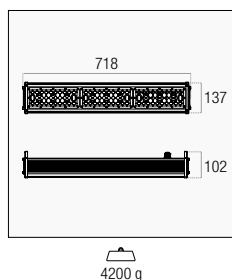

	SOURCE		OUTPUT						
150 W	25.380 lm	22.000 lm	120° ∠	Dimm. 1-10 V	5000K		<b>EXTR-1501250</b>	1/1	€ 348,00
	22.500 lm	19.500 lm	120° ∠	Dimm. DALI-2	5000K		<b>EXTRDL-1501250</b>	1/1	€ 432,00



Kit sospensione (1,5 m) incluso  
Suspension kit (1.5 mt) included

### OPZIONALE / OPTIONAL

#### SUPPORTI / SUPPORTS - 2 pz

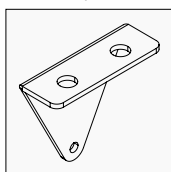

Fissi / Fixed	<b>EXTR-KIT</b>	2/25	€ 24,00
---------------	-----------------	------	---------



#### SUPPORTI / SUPPORTS - 2 pz

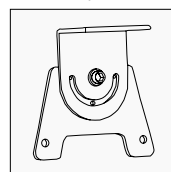

Orient. ± 50°	<b>EXTR-ROTAB</b>	2/25	€ 46,00
---------------	-------------------	------	---------



#### DAYLIGHT SENSOR

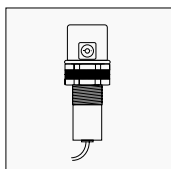

Daylight sensor	<b>EXTR-SENS</b>	1/100	€ 77,00
-----------------	------------------	-------	---------

Auto dimmerazione che mantiene costante l'illuminazione della stanza in funzione della luce ambientale.

*Self-dimming able to keep room lighting constant according to the ambient light.*

Solo per / Only for  
**EXTR-1501250**

#### KIT LENTI / LENS - 3 pz

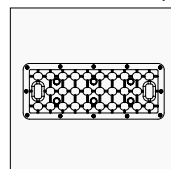

30° - 70° ∠	<b>EXTR3-LENS3070</b>	3/50	€ 53,00
40° - 120° ∠	<b>EXTR3-LENS40120</b>		
50° - 90° ∠	<b>EXTR3-LENS5090</b>		

Corpo in alluminio pressofuso ad elevata dissipazione di calore. Lente in PC resistente alle intemperie e agli urti.  
Facile da installare grazie a 2 cavi di sospensione in dotazione.

Die-cast aluminum body with high heat dissipation. Weatherproof and impact resistant PC lens.  
Easy installation with 2 suspension cables supplied.





# DISCOVERY

## Dimmerabile



Dimmerabile con sistemi 1-10 V  
Dimmable with 1-10 V systems

	A mm	g
150 W	Ø330	3420
200 W	Ø380	4940

OUTPUT

150 W	19.800 lm	110° ∠	Dimm. 1-10 V	4000K	<b>DSCD-15011040</b>	1/1	€264,00
200 W	26.400 lm	110° ∠	Dimm. 1-10 V	4000K	<b>DSCD-20011040</b>	1/1	€ 348,00

Cavo di sicurezza da 35 cm incluso  
35 cm safety cable included

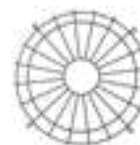

Griglia di protezione opzionale  
Optional protection grid

<b>DSCD-GRIK08</b>	1/1	€21,00
--------------------	-----	--------



Shell in alluminio opzionale  
Optional aluminum shell

<b>DSCD150-120S</b>	1/1	€41,00
---------------------	-----	--------

Speciale ottica con vetro temperato che focalizza il flusso luminoso. Corpo in alluminio pressofuso 1060. Massima resistenza alla corrosione, verniciatura ad elettroforesi.

Special focus optic with tempered glass. 1060 die-cast aluminum body. Max resistance to corrosion, electrophoresis painting.





**NEW**

SOSPENSIONI INDUSTRIALI





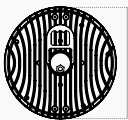

# DISCOVERY MAX



SOSP. INDUS.

	A	
	60	
	A mm	g
100 W	Ø 220	1600
150 W	Ø 260	2200
200 W	Ø 300	2900

## OUTPUT

100 W	11.829 lm	110° ∠	4000K		<b>DSCM-10011040 NEW</b>	1/4 	€108,00
150 W	16.875 lm	110° ∠	4000K		<b>DSCM-15011040 NEW</b>	1/4 	€166,00
200 W	22.566 lm	110° ∠	4000K		<b>DSCM-20011040 NEW</b>	1/4 	€214,00



Sospensione industriale ad alta dissipazione. Struttura robusta e resistente agli urti. Installazione a sospensione tramite supporto incluso oppure a parete / soffitto tramite staffa opzionale.

High dissipation industrial suspension. Sturdy and shock-resistant structure. Hanging installation with included hook or wall / ceiling mounting with optional bracket.

Supporto per installazione a sospensione  
Suspended installation support included



Staffa montaggio a parete / soffitto opzionale  
Optional wall / ceiling mounting bracket



<b>DSCM-BK NEW</b>	1/30 	€26,00
--------------------	--	--------





PROIETTORI  
PROIETTORI  
**PROIETTORI**  
PROIETTORI  
PROIETTORI

FLOODLIGHT  
FLOODLIGHT  
**FLOODLIGHT**  
FLOODLIGHT  
FLOODLIGHT

SIRIO SIRIO SIRIO SIRIO  
**SIRIO SIRIO SIRIO SIRIO**  
SIRIO SIRIO SIRIO SIRIO  
SLIM SLIM SLIM SLIM  
**SLIM SLIM SLIM SLIM**  
SLIM SLIM SLIM SLIM



**NEW**

PROIETTORI

# SIRIO SLIM

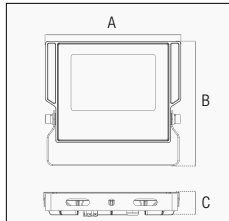

	A mm	B mm	C mm	g
20 W	160	147	29	480
30 W	160	147	29	480
50 W	200	178	29	760
70 W	270	230	29	1400
100 W	270	230	29	1400
150 W	366	303	34	2800
200 W	366	303	34	2800
300 W	395	338	44	3800
400 W	450	382	48	5200

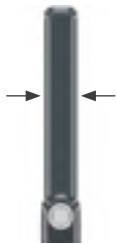

Ultraslim da 29 mm

OUTPUT									
20 W	2.100 lm	110° ∠	Grigio / Grey ●	4000K	<b>SRS-209540</b>	1/24	€ 26,00		
				6000K	<b>SRS-209560</b>				
			Bianco / White ○	4000K	<b>SRSB-209540</b>				
30 W	3.150 lm	110° ∠	Grigio / Grey ●	4000K	<b>SRS-309540</b>	1/24	€ 31,00		
				6000K	<b>SRS-309560</b>				
			Bianco / White ○	4000K	<b>SRSB-309540</b>				
50 W	5.250 lm	110° ∠	Grigio / Grey ●	4000K	<b>SRS-509540</b>	1/20	€ 35,00		
				6000K	<b>SRS-509560</b>				
			Bianco / White ○	4000K	<b>SRSB-509540</b>				
70 W	7.350 lm	110° ∠	Grigio / Grey ●	4000K	<b>SRS-709540</b>	1/12	€ 61,00		
				6000K	<b>SRS-709560</b>				
			Bianco / White ○	4000K	<b>SRSB-709540</b>				
100 W	10.500 lm	110° ∠	Grigio / Grey ●	4000K	<b>SRS-1009540</b>	1/12	€ 103,00		
				6000K	<b>SRS-1009560</b>				
			Bianco / White ○	4000K	<b>SRSB-1009540</b>				
150 W	15.750 lm	110° ∠	Grigio / Grey ●	4000K	<b>SRS-1509540</b>	1/6	€ 130,00		
				6000K	<b>SRS-1509560</b>				
			Bianco / White ○	4000K	<b>SRSB-1509540</b>				
200 W	21.000 m	110° ∠	Grigio / Grey ●	4000K	<b>SRS-2009540</b>	1/6	€ 146,00		
				6000K	<b>SRS-2009560</b>				
			Bianco / White ○	4000K	<b>SRSB-2009540</b>				
300 W	33.729 lm	30° ∠	Grigio / Grey ●	4000K	<b>SRS-3003040 NEW</b>	1/4	€ 259,00		
	35.540 lm	60° ∠	Grigio / Grey ●	4000K	<b>SRS-3006040 NEW</b>				
	35.786 lm	90°x150° ∠	Grigio / Grey ●	4000K	<b>SRS-3009040 NEW</b>				
	36.200 lm	120° ∠	Grigio / Grey ●	4000K	<b>SRS-30012040 NEW</b>				
400 W	43.813 lm	30° ∠	Grigio / Grey ●	4000K	<b>SRS-4003040 NEW</b>	1/4	€ 335,00		
	46.541 lm	60° ∠	Grigio / Grey ●	4000K	<b>SRS-4006040 NEW</b>				
	46.316 lm	90°x150° ∠	Grigio / Grey ●	4000K	<b>SRS-4009040 NEW</b>				
	47.673 lm	120° ∠	Grigio / Grey ●	4000K	<b>SRS-40012040 NEW</b>				



**Scaricatore di sovratensione**  
Surge Protection Device

Struttura in alluminio resistente e ultraslim, da 29 mm di spessore. Completamente protetto contro polveri e acqua.

Ultra-slim and strong aluminum structure, only 29 mm thickness. Dustproof and water resistant.



I modelli da 300 W e 400 W sono dotati di SPD da 10 kV. Evita danneggiamento del prodotto in caso di forti cariche elettrostatiche o sovratensioni.

300 W and 400 W models are equipped with 10 kV SPD. It prevents damage to the product in the event of strong electrostatic charges or overvoltages.

**NEW**

PROIETTORI

# SIRIO BT

## 12-36 V/DC

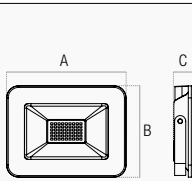
**12-36 V  
AC/DC**

	A mm	B mm	C mm	g
20 W	120	115	24	250
30 W	155	125	24	350
50 W	200	165	33	600

## OUTPUT

Power (W)	Lumen (lm)	Beam Angle	Voltage	Color Temp (K)	Model	Quantity	Price (€)
20 W	1.750	110°	S.E.L.V.	4000K	<b>SRSBT-203640 NEW</b>	1/16	€ 29,00
30 W	2.540	110°	S.E.L.V.	4000K	<b>SRSBT-303640 NEW</b>	1/16	€ 38,50
50 W	4.400	110°	S.E.L.V.	4000K	<b>SRSBT-503640 NEW</b>	1/16	€ 69,50



Corpo in PC anti invecchiamento, parabola bugnata ad elevata riflettanza. Vetro opale antiabbaglio, piastra in puro alluminio ad alto potere dissipante.

Anti-aging PC body, high reflectance embossed parabola. Anti-glare opal glass, pure aluminum plate with high dissipating power.

**S.E.L.V. (SRP)**

Safety Extra Low Voltage

Ideale in sistemi di videosorveglianza e sicurezza con pannelli fotovoltaici, su imbarcazioni, mezzi da cantiere e di soccorso.

Suitable for video surveillance and security systems with photovoltaic panels, on boats, construction and rescue vehicles.



PROIETTORI

# DMEMORY

## Asimmetrico



Mercato Centrale di Livorno  
Ph: Andrea Dani

PROIETTORI

	A mm	B mm	C mm	g
100 W	282	41	321	1720
200 W	385	51	470	5400

OUTPUT

100 W	13.300 lm	145°x60°∠	4000K		<b>DMASI-1009540</b>	1/4	€ 120,00
200 W	27.250 lm	145°x60°∠	4000K		<b>DMASI-2009540</b>	1/3	€ 252,00



Lente asimmetrica  
Asymmetrical lens  
145 x 60° ∠

Corpo in alluminio pressofuso 1060. Massima resistenza alla corrosione, verniciatura ad elettroforesi. Fascio luminoso asimmetrico con ottica integrata, consente di concentrare il flusso luminoso sull'area desiderata.

1060 die-cast aluminum body. Maximum corrosion resistance, electrophoresis painting. Asymmetrical light beam with integrated optics, allows you to concentrate the luminous flux on the desired area.

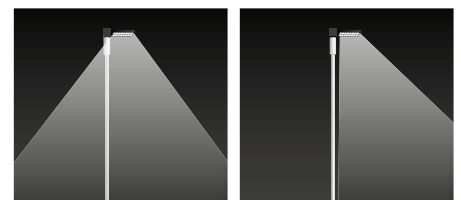

Lente simmetrica  
Symmetrical lens

Lente asimmetrica  
Asymmetrical lens



CENTURY®





STANDARD



SENSOR



PIR  
Sensor



Crepuscolare  
Light sensor

# SHUTTLE SLIM

## STANDARD

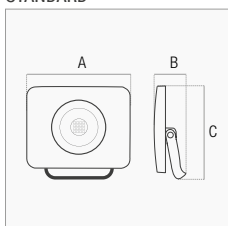

	A mm	B mm	C mm	g
10 W	95	32	76	190
20 W	120	32	95	238
30 W	150	38	120	330
50 W	188	38	145	580

## OUTPUT

10 W	720 lm	110° ∠	Standard	4000K	<b>SHSLIM-109540</b>	1/24	€ 15,00
20 W	1.500 lm	110° ∠	Standard	4000K	<b>SHSLIM-209540</b>	1/24	€ 19,00
30 W	2.340 lm	110° ∠	Standard	4000K	<b>SHSLIM-309540</b>	1/12	€ 26,00
50 W	4.000 lm	110° ∠	Standard	4000K	<b>SHSLIM-509540</b>	1/6	€ 40,00



## SENSOR

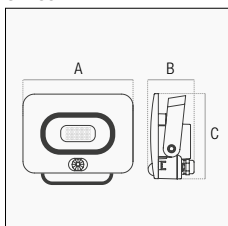

	A mm	B mm	C mm	g
10 W	142	48	102	350
20 W	142	48	102	350
30 W	175	52	124	460
50 W	205	52	146	650

## OUTPUT

10 W	720 lm	110° ∠	PIR Sensor	4000K	<b>SHSLIS-109540</b>	1/24	€ 32,00
20 W	1.500 lm	110° ∠	PIR Sensor	4000K	<b>SHSLIS-209540</b>	1/24	€ 36,00
30 W	2.340 lm	110° ∠	PIR Sensor	4000K	<b>SHSLIS-309540</b>	1/12	€ 44,00
50 W	4.000 lm	110° ∠	PIR Sensor	4000K	<b>SHSLIS-509540</b>	1/6	€ 56,00



## SENSOR



On-Off automatico giorno-notte  
Automatic day-night on-off



3 - 2.000 Lux

Regolazione della sensibilità alla luce del sensore  
Sensor light sensitivity adjustment

30 sec - 10 min

Regolazione del periodo di accensione  
Adjustment of the on-off time

Design ultrapiatto, scocca in alluminio pesante, vetro temperato.

Ultra-flat design, heavy aluminum shell, tempered glass.





3000K



4000K

Modula la luce a tuo piacimento.  
Un solo prodotto con 3 colori luce.



Modulate the light to your liking.  
One product with 3 light colors.

6500K



**NEW**

PROIETTORI

# PORTEO20 - PORTEO30 PORTEO50



PROIETTORI

**CCT**  
3000K-6500K

	A mm	B mm	g
20 W	162	144	510
30 W	162	144	510
40 W	224	203	900

SOURCE		OUTPUT					
20 W	2.711 lm	2.000 lm	110° ∠	Bianco / White ○ CCT 3000K - 4000K - 6500 K	<b>PTOBI-209500 NEW</b>	1/24	€ 32,50
				Ruggine /Corten ● CCT 3000K - 4000K - 6500 K	<b>PTOCO-209500 NEW</b>		
				Nero / Black ● CCT 3000K - 4000K - 6500 K	<b>PTONE-209500 NEW</b>		
30 W	3.664 lm	3.000 lm	110° ∠	Bianco / White ○ CCT 3000K - 4000K - 6500 K	<b>PTOBI-309500 NEW</b>	1/24	€ 39,50
				Ruggine /Corten ● CCT 3000K - 4000K - 6500 K	<b>PTOCO-309500 NEW</b>		
				Nero / Black ● CCT 3000K - 4000K - 6500 K	<b>PTONE-309500 NEW</b>		
40 W	5.076 lm	4.600 lm	110° ∠	Bianco / White ○ CCT 3000K - 4000K - 6500 K	<b>PTOBI-409500 NEW</b>	1/12	€ 49,00
				Ruggine /Corten ● CCT 3000K - 4000K - 6500 K	<b>PTOCO-409500 NEW</b>		
				Nero / Black ● CCT 3000K - 4000K - 6500 K	<b>PTONE-409500 NEW</b>		

Proiettore LED in alluminio pressofuso in 3 finiture e 3 potenze. Schermo in vetro smerigliato e valvola anticondensa. Resistente ad acqua e polvere. Tramite selettore è possibile selezionare il colore luce desiderato.

Die-cast aluminum LED floodlight in 3 finishes and 3 powers. Frosted glass screen and anti-condensation valve. Resistant to water and dust. Through selector you can select the desired light color.



Vetro smerigliato  
Frosted glass



Speciale valvola anticondensa  
Special anti-condensation valve

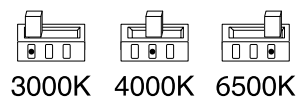

Regolazione colore luce tramite selettore  
Light color adjustment by selector





# HORIENTA12

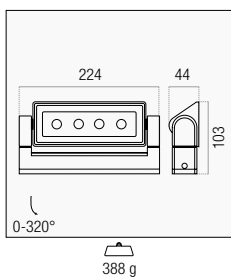

OUTPUT						
12 W	830 lm	90° ∠	4000K	<b>HO-129540</b>	1/12	€ 48,00



Dissipatore in alluminio pressofuso  
Die-cast aluminum heatsink

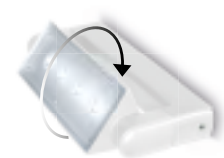

320° Rotazione della fonte luminosa  
320° light source rotation

Dissipatore alettato in alluminio pressofuso, ottica in PC con lenti antiabbaglio. Staffa in ABS resistente ai raggi UV con rotazione di 320°. Applicazione soffitto-parete.

Die-cast aluminum finned heatsink, PC optics with anti-glare lenses. UV resistant ABS bracket with 320° rotation. Ceiling-wall application.



PROIETTORI

# RAINBOW



PROIETTORI



	A	B	C	
	A mm	B mm	C mm	g
10 W	104	27	125	210
50 W	200	36	237	880

10 W	120°	RGB	<b>RBW-109510</b>	1/16	€ 35,00
50 W	120°	RGB	<b>RBW-509510</b>	1/12	€ 67,00

Telecomando RF 2.4 GHz incluso  
2.4 GHz RF remote control included

Proiettore RGB ideale per la creazione di scenari unici. Tramite il telecomando in dotazione è possibile selezionare facilmente il colore o il gioco di luce desiderato. Corpo in alluminio ad alta dissipazione.

RGB floodlight suitable for unique scenarios. Easy selection of colors or light effects by included remote control. High dissipation aluminum body.



Modalità cambio colore  
Color change mode



Veloce Jump    Dissolvenza Shade



Vari colori e giochi di luce  
Various colors and light effects



CENTURY





ARREDO URBANO  
ARREDO URBANO  
**ARREDO URBANO**  
ARREDO URBANO  
ARREDO URBANO

STREET  
STREET  
**STREET**  
STREET  
STREET

# SHARK

## Dimmerabile



60 W

90 W - 120 W

Attacco per pali da Ø 60 mm  
Adapter for Ø 60 mm poles

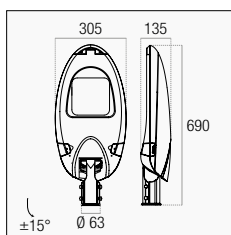

665 g

OUTPUT

60 W	7.000 lm	90° - 144° ∠	Grigio Polvere / Dusty Grey ● RAL 7037	Dimm. 1-10 V	4000K	<b>SHARKD-609540</b>	1/1	€ 432,00
------	----------	--------------	--	--------------	-------	----------------------	-----	----------

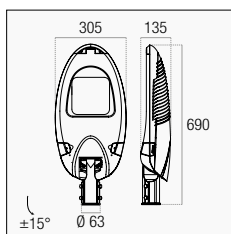

665 g

OUTPUT

90 W	10.500 lm	90° - 144° ∠	Grigio Polvere / Dusty Grey ● RAL 7037	Dimm. 1-10 V	4000K	<b>SHARKD-909540</b>	1/1	€ 504,00
120 W	12.000 lm	90° - 144° ∠	Grigio Polvere / Dusty Grey ● RAL 7037	Dimm. 1-10 V	4000K	<b>SHARKD-1209540</b>	1/1	€ 672,00



Dimmerabile con sistemi 1-10 V  
Dimmable with 1-10 V systems

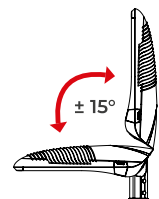

Corpo e telaio in alluminio.  
Verniciatura resistente alla corrosione.  
Diffusore in vetro temperato resistente agli shock termici.

Aluminum body and frame.  
Corrosion resistant paint.  
Thermal shock resistant tempered glass diffuser.



Provisto di ganasce per il bloccaggio  
Provided with jaws for locking

UP

ARREDO URBANO

# EVOSTREET



60 W - 90 W  
UPGRADE

120 W - 150 W

Attacco per pali da Ø 60 mm  
Adapter for Ø 60 mm poles



ARR. URBANO

	A	B	C	
	±15°	Ø 64		
	A	B	C	g
60 W	228	135	590	3975
90 W	256	141	606	5400
120 W	260	130	690	6000
150 W	260	130	690	6000

SOURCE		OUTPUT						
60 W	9.000 lm	7.200 lm	90° - 144° ∠	100-240 V/AC 50/60 Hz	4000K	<b>EVOS-609540 UPGRADE</b>	1/1	€ 238,00
90 W	13.500 lm	10.800 lm	90° - 144° ∠	100-240 V/AC 50/60 Hz	4000K	<b>EVOS-909540 UPGRADE</b>	1/1	€ 336,00
120 W	18.000 lm	14.400 lm	90° - 144° ∠	180-270 V/AC 50/60 Hz	4000K	<b>EVOS-1209540</b>	1/1	€ 396,00
150 W	22.500 lm	18.000 lm	90° - 144° ∠	180-270 V/AC 50/60 Hz	4000K	<b>EVOS-1509540</b>	1/1	€ 420,00



Facile regolazione con tacche di bloccaggio ±15°  
Easy adjustment with ± 15° locking notches

Robusta armatura stradale in alluminio pressofuso dotata di vetro temperato resistente agli shock termici. Sezionatore di serie che interrompe l'alimentazione elettrica all'apertura della calotta superiore.

Sturdy die-casting aluminum road lighting, equipped with tempered glass thermal shockproof. Switch disconnecter able to cut off the power supply when the cover is opened.



Idoneo per fissaggio testa-palo e diretto  
Suitable for post-top and straight fixing



CENTURY



ARREDO URBANO

# ZEROTONDO



Attacco per pali da Ø 60 mm  
Adapter for Ø 60 mm poles

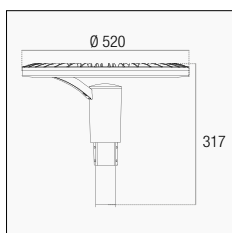

5000 g

#### OUTPUT

60 W	4.650 lm	100° ∠	Grigio Grafite / Graphite Grey ● RAL 7024	4000K	<b>ZTD-605240</b>	1/1	€ 408,00
------	----------	--------	---	-------	-------------------	-----	----------

Struttura in alluminio pressofuso, lente opale in PC. Resistente alla corrosione.

Die-cast aluminum structure, PC opal lens. Corrosion resistant.



Ideale per viali, giardini pubblici, residence  
Ideal for avenues, public gardens, residences

UP

ARREDO URBANO

# CITYONE



ARR. URBANO

Attacco per pali da Ø 60 - Ø 67 mm  
Connection for Ø 60 - Ø 67 mm poles

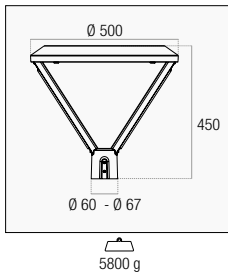
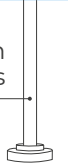

SOURCE		OUTPUT				CTY-604540 UPGRADE	1/1	€ 372,00
60 W	8.100 lm	7.800 lm	138° ∠	4000K				

New design  
Better performance

RICAMBIO / SPARE PART



Riduttore / Adapter  
Ø 75 mm → Ø 60 mm

ATP-CTY NEW	1/6	€ 16,00
-------------	-----	---------

Struttura in alluminio pressofuso, lente opale in PC. Resistente alla corrosione.

Die-cast aluminum structure, PC opal lens. Corrosion resistant.







OUTDOOR  
OUTDOOR  
**OUTDOOR**  
OUTDOOR  
OUTDOOR

GARDEN  
GARDEN  
**GARDEN**  
GARDEN  
GARDEN



GARDEN  
GARDEN  
**GARDEN**  
GARDEN  
GARDEN



OUTDOOR- GARDEN

# LILANDÀ



OUTDOOR

220 CM

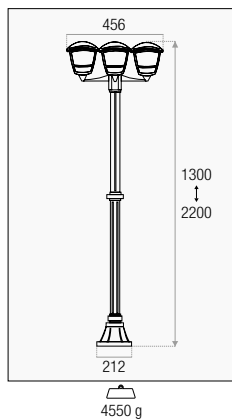

3 x 10 W	1.850 lm	4000K	<b>LLD3P-108040</b>	1/1	€ 228,00
----------	----------	-------	---------------------	-----	----------

Altezza regolabile  
Adjustable height

#### RICAMBIO / REPLACEMENT

Sorgente LED con driver  
LED source with driver



Lampione in alluminio con verniciatura ad elettrolisi. Progettato per ambienti esterni, resistente alla corrosione.

Aluminum lamppost with electrophoresis painting. Designed for outdoor ambience, corrosion resistant.



10 W	806 lm	4000K	<b>RSLLD</b>	1/100	€ 16,00
------	--------	-------	--------------	-------	---------



**CENTURY**





LLDAL-108040



LLDBA-108040



LLDSE-108040

# LILANDÀ

## DISCENDENTE / DESCENDING

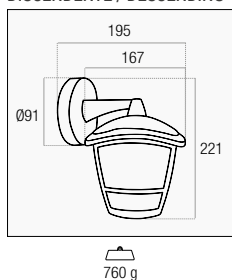

10 W	806 lm	Standard	4000K	<b>LLDAL-108040</b>	1/6	€ 40,00
------	--------	----------	-------	---------------------	-----	---------

## ASCENDENTE / ASCENDING

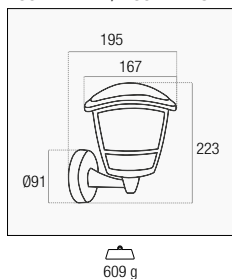

10 W	806 lm	Standard	4000K	<b>LLDBA-108040</b>	1/6	€ 40,00
------	--------	----------	-------	---------------------	-----	---------

## SENSOR

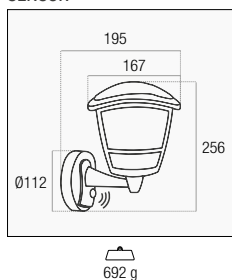

10 W	806 lm	PIR Sensor	4000K	<b>LLDSE-108040</b>	1/6	€ 50,00
------	--------	------------	-------	---------------------	-----	---------



Applique in alluminio con verniciatura ad elettrolisi. Progettato per ambienti esterni, resistente alla corrosione.

Aluminum wall lamp with electrophoresis painting. Designed for outdoor ambience, corrosion resistant.



10 W	806 lm	4000K	<b>RSLLD</b>	1/100	€ 16,00
------	--------	-------	--------------	-------	---------

### RICAMBIO / REPLACEMENT

Sorgente LED con driver  
LED source with driver







ALADINO  
ALD-051630



ALADINO  
ALD-056030



GAUDINO  
GDN-051530



GAUDINO  
GDN-058030



PALADINO  
PLD-051230



PALADINO  
PLD-058030

# ALADINO - GAUDINO - PALADINO

## ALADINO

		5,5 W	360 lm	220-240 V/AC 50/60 Hz	Applique	Silver ● RAL 7040	3000K	<b>ALD-051630</b>	1/12	€ 72,00
			450 lm	195-265 V/AC 50/60 Hz	Paletto / Pole	Silver ● RAL 7040	3000K	<b>ALD-056030</b>	1/6	€ 106,00
1300 g	2220 g									

## GAUDINO

		5,5 W	360 lm	220-240 V/AC 50/60 Hz	Applique	Silver ● RAL 7040	3000K	<b>GDN-051530</b>	1/24	€ 50,00
			450 lm	220-240 V/AC 50/60 Hz	Paletto / Pole	Silver ● RAL 7040	3000K	<b>GDN-058030</b>	1/6	€ 101,00
480 g	1900 g									

## PALADINO

		6 W	450 lm	195-265 V/AC 50/60 Hz	Applique	Silver ● RAL 7040	3000K	<b>PLD-051230</b>	1/8	€ 67,00
			4 W	270 lm	195-265 V/AC 50/60 Hz	Paletto / Pole	Silver ● RAL 7040	3000K	<b>PLD-058030</b>	1/12
980 g	2000 g									

### RICAMBIO DRIVER / SPARE DRIVER



5,5 W	<b>RDALD-051630</b>	1/1	€ 16,00
	<b>RDALD-056030</b>		
	<b>RDGDN-051530</b>		
6 W	<b>RDGDN-058030</b>	1/1	€ 16,00
	<b>RDPLD-051230</b>		
	<b>RDPLD-058030</b>		

Paletto fissaggio a pavimento e applique fissaggio a parete.  
Corpo in alluminio anticorrosione.

Bollard light and wall applique.  
Corrosion-resistant aluminum body.



OUTDOOR - GARDEN

# SPIKE LIGHT

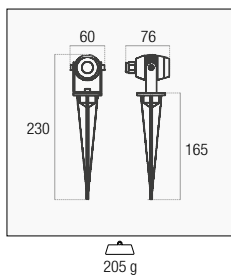

3 W	135 lm	3000K	<b>SPK-032230</b>	1/30	€ 40,00
-----	--------	-------	-------------------	------	---------

Picchetto con faretto Led in alluminio pressofuso. Fattore di protezione IP65, facile da installare.

Spike with LED spotlight in die-cast aluminum. IP65 protection factor, easy to install.



Alimentatori, connettori e accessori  
Power supplies, connectors and accessories  
**PAG. 191**



OUTDOOR - GARDEN

# DOBI



OUTDOOR

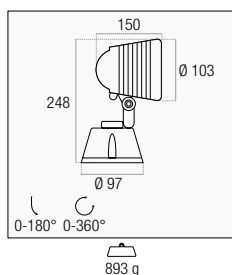

15 W	1.200 lm	Grigio Alluminio / Grey Aluminum ● RAL 9006	3000K	<b>DOBIG-154530</b>	6/12	€ 72,00
			4000K	<b>DOBIG-154540</b>		
		Nero Segnale / Signal Black ● RAL 9004	3000K	<b>DOBIN-154530</b>		
			4000K	<b>DOBIN-154540</b>		

Faretto LED IP65. Grazie al fascio di luce a 45° e alla mobilità sia sull'asse verticale che orizzontale, è possibile illuminare gli oggetti in maniera efficace e scenica. Corpo in alluminio pressofuso, con ampie alettature per un'elevata dissipazione.

IP65 LED spotlight with adjustable angle beam both on the vertical and horizontal axis for an effective and scenic lighting. Die-cast aluminum body with large fins for high heating dissipation.

Regolabile  
Adjustable



OPZIONALE / OPTIONAL

Picchetto per installazione nel terreno  
Spike for ground installation

Grigio / Grey ●	<b>DOBIG-SPK</b>	1/100	€ 11,00
Nero / Black ●	<b>DOBIN-SPK</b>		



OUTDOOR - GARDEN

# FIESTA



FSTABCL



FSTACL



FSTACO

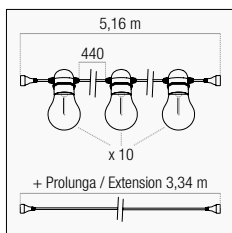

1000 g

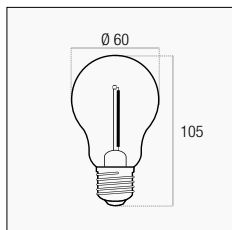

25 g

6 W	500 lm	Clear  + Cavo Bianco / White Cable  2200K	<b>FSTABCL-062722</b>	1/5	€ 96,00
		Clear  + Cavo Nero / Black Cable  2200K	<b>FSTACL-062722</b>		
	200 lm	Multicolor  + Cavo Nero / Black Cable  Multicolor	<b>FSTACO-062722</b>		

Lampadine intercambiabili  
Interchangeable bulbs

#### RICAMBIO LAMPADA / SPARE BULB

0,6 W	50 lm	Clear  2200K	<b>FSTARCL-062722</b>	1/100	€ 6,00
	20 lm	Blu / Blue	<b>FSTARBLU-062722</b>		
		Giallo / Yellow	<b>FSTARGI-062722</b>		
		Magenta	<b>FSTARMAG-062722</b>		
		Rosso / Red	<b>FSTARRO-062722</b>		
		Verde / Green	<b>FSTARVE-062722</b>		

#### RICAMBIO DRIVER / SPARE DRIVER



12 W	<b>FSTADAP-12W</b>	1/30	€ 19,00
------	--------------------	------	---------

Catena luminosa di 10 lampade a filamento LED incluse alimentate a bassa tensione. Possibilità di collegare 2 catene insieme. Driver incluso con spina schuko.

String lighting with 10 LED Filament lamps included and powered by low voltage. 2 chains can be connected together. Driver included with schuko plug.



Crea atmosfere uniche e suggestive  
Create unique and amazing atmospheres



**NEW**

OUTDOOR - GARDEN

# FIESTA 230 V

15 portalampane E27  
15 E27 lamp holders

Catena luminosa collegabile in serie, MAX 230 W  
Linkable string lighting, MAX 230 W

OUTDOOR

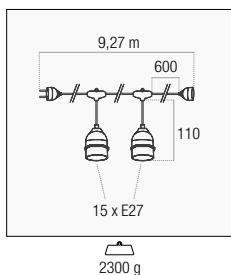

SINGLE		SYSTEM					
15 x E27	MAX 15 W	MAX 230 W	Bianco / White ○	<b>FSTAB-2202700 NEW</b>	1/6	€ 72,00	
			Nero / Black ●	<b>FSTAN-2202700 NEW</b>			



Include presa Schuko per collegare i tuoi dispositivi  
Schuko socket included to connect your devices  
MAX 230 W TOTAL

Catena luminosa con 15 portalampane E27, lampade non incluse. Collegabile in serie fino a 230 W totali.

String lighting with 15 E27 lamp holders, lamps not included. Connectable in series up to 230 W total.



Non include / Not included  
Vedi / Ref.

INCANTO FILAMENTO ING3-042727





OUTDOOR  
OUTDOOR  
**OUTDOOR**  
OUTDOOR  
OUTDOOR

CALPESTABILILI  
CALPESTABILILI  
**CALPESTABILILI**  
CALPESTABILILI  
CALPESTABILILI

WALKABLE  
WALKABLE  
**WALKABLE**  
WALKABLE  
WALKABLE



PAVI2L-087030



PAVI4L-0513030

# PAVI

SUPERFICIE / SURFACE

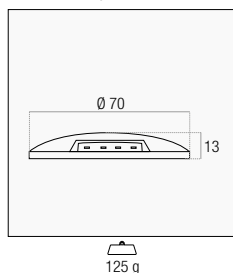

0,4 W	8 lm	100° ∠	24 V AC/DC	1 Luce / Light	3000K	<b>PAVI1L-047030</b>	6/24	€ 19,00
					4000K	<b>PAVI1L-047040</b>		
0,8 W	16 lm	100° ∠	24 V AC/DC	2 Luci / Lights	3000K	<b>PAVI2L-087030</b>	6/24	€ 23,00
					4000K	<b>PAVI2L-087040</b>		

INCASSO / RECESSED

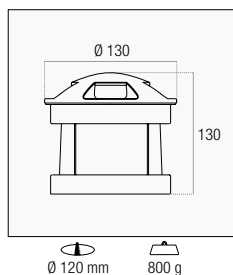

5 W	160 lm	100° ∠	24 V AC/DC	Grigio / Grey	2 Luci / Lights	3000K	<b>PAVIC2L-0513030</b>	1/6	€ 74,00
						4000K	<b>PAVIC2L-0513040</b>		
					4 Luci / Lights	3000K	<b>PAVIC4L-0513030</b>		
						4000K	<b>PAVIC4L-0513040</b>		

Controcassa in policarbonato inclusa  
Casing in polycarbonate included

OUTDOOR

Calpestabile luce radente a superficie o a incasso per installazione a pavimento. Corpo in alluminio, cavo in neoprene. Resistenza a pressione di 500 Kg.

Walkable surface or recessed glancing light for floor installation. Aluminum body, neoprene cable. Maximum resistance to pressure of 500 Kg.

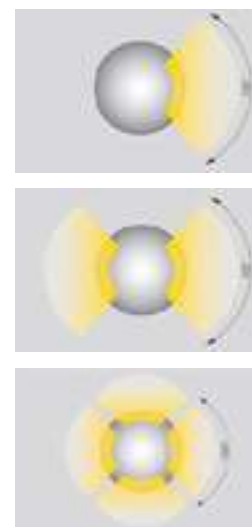

1, 2 o 4 luci con angolo di 100°  
1, 2 or 4 lights with 100 ° angle

Alimentatori, connettori e accessori  
Power supplies, connectors and accessories  
**PAG. 191**

# LINEA PAVI

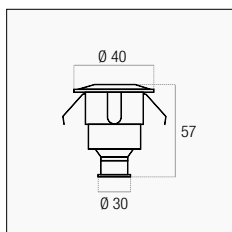

Ø 32 mm    75 g

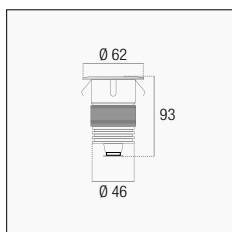

Ø 55 mm    228 g

1 W	70 lm	30° ∠	24 V AC/DC	3000K <span style="color: yellow;">■</span>	<b>MP-014030</b>	6/24	€ 26,00
				4000K <span style="color: green;">■</span>	<b>MP-014040</b>		

Installabile anche a parete o soffitto  
Suitable also for wall or ceiling installation

3 W	90 lm	100° ∠	24 V AC/DC	3000K <span style="color: yellow;">■</span>	<b>MP-036030</b>	6/24	€ 46,00
				4000K <span style="color: green;">■</span>	<b>MP-036040</b>		

Installabile anche a parete o soffitto, controcassa in policarbonato inclusa  
Suitable also for wall or ceiling installation, polycarbonate case included

Incasso tondo per installazione a parete, soffitto o pavimento. Anello in alluminio satinato (1W) o in acciaio inox (3W). Corpo in alluminio, vetro temperato, cavo in neoprene.

Round recessed wall light, ceiling or floor installation. Ring in brushed aluminum (1W) or in stainless steel (3W). Aluminum body, tempered glass, neoprene cable.



Controcassa in policarbonato  
Polycarbonate case



Alimentatori, connettori e accessori  
Power supplies, connectors and accessories  
**PAG. 191**



CALPESTABILI

# PAVI GU10



OUTDOOR

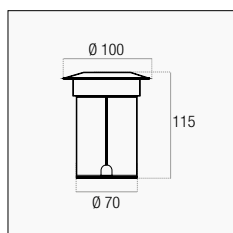

Ø 87 mm 580 g

1 x GU10	PAVI-GU10	1/6	€ 29,00
----------	-----------	-----	---------



GU10

Non inclusa /Not included  
Vedi / Ref.

LEXAR 6W / 8W

Incasso tondo calpestabile per installazione a pavimento. Anello e corpo in alluminio, vetro temperato, cavo in neoprene. Resistenza a pressione di 500 Kg.

Walkable round recessed light for floor installation. Aluminum ring and body, tempered glass, neoprene cable. Pressure resistance of 500 Kg.



Controcassa in policarbonato  
Polycarbonate case

Alimentatori, connettori e accessori  
Power supplies, connectors and accessories  
**PAG. 191**





PAVI-078930



PAVI-1216030

# PAVI

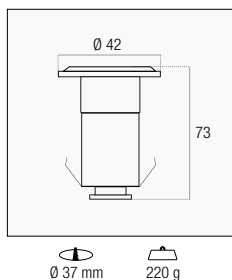

1 W	80 lm	24° ∠	24 V AC/DC	IP67- IK06	3000K	<b>PAVI-014230</b>	6/24	€ 36,00
					4000K	<b>PAVI-014240</b>		

Controcassa in policarbonato inclusa  
Polycarbonate case included

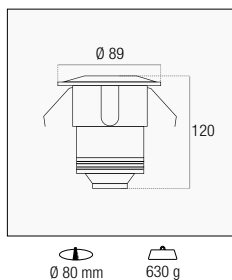

3 W	240 lm	12° ∠	24 V AC/DC	IK06	3000K	<b>PAVI-038930</b>	1/6	€ 67,00
					4000K	<b>PAVI-038940</b>		
7 W	480 lm	12° ∠	24 V AC/DC	IK06	3000K	<b>PAVI-078930</b>	1/6	€ 70,00
					4000K	<b>PAVI-078940</b>		

Controcassa in policarbonato inclusa  
Polycarbonate case included

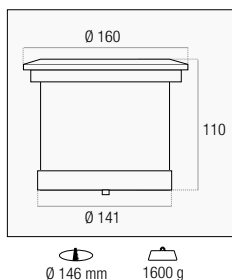

12 W	840 lm	10° ∠	24 V AC/DC	IK08	3000K	<b>PAVI-1216030</b>	1/6	€ 120,00
					4000K	<b>PAVI-1216040</b>		

Controcassa in policarbonato inclusa  
Polycarbonate case included

Incasso tondo calpestabile per installazione a pavimento. Anello e corpo in alluminio, vetro temperato, cavo in neoprene. Resistenza a pressione di 500 Kg.

Walkable round recessed light for floor installation. Aluminum ring and body, tempered glass, neoprene cable. Pressure resistance of 500 Kg.



Controcassa in policarbonato  
Polycarbonate case





Alimentatori, connettori e accessori  
Power supplies, connectors and accessories  
**PAG. 191**





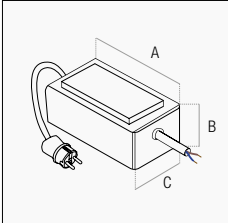

OUTDOOR  
OUTDOOR  
**OUTDOOR**  
OUTDOOR  
OUTDOOR

# ALIMENTATORI POWER SUPPLY

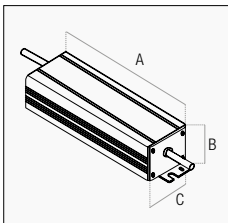
			IN	OUT		A	B	C					
	IP68	60 W	2.500 mA	230 V/AC 50/60 Hz	24 V/AC	No Dimm.	93	69	63	1300 g	<b>DR60</b>	1/10 	€ 46,00
		80 W	3.334 mA	230 V/AC 50/60 Hz	24 V/AC	No Dimm.	124	71	79	2000 g	<b>DR80</b>	1/6 	€ 67,00

			IN	OUT		A	B	C					
	IP67	50 W	2.100 mA	175-264 V/AC 50/60 Hz	24 V/DC	No Dimm.	200	25	35	263 g	<b>RDAC50-2467</b>	1/50 	€ 36,00
		100 W	4.200 mA	175-264 V/AC 50/60 Hz	24 V/DC	No Dimm.	180	20	65	355 g	<b>RDAC100-2467</b>	1/30 	€ 62,00

# CONNETTORI DI GIUNZIONE JUNCTION CONNECTORS

BOX 3 VIE / 3 WAY

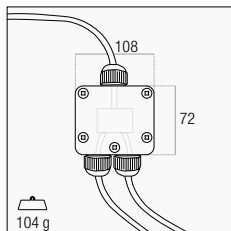

		CAVI / CABLE	SEZIONE / SECTION			
IP68	MAX 450 V 24 A	Ø 4 mm - Ø 12 mm	3 x 2,5 mm <sup>2</sup>	<b>CNB</b>	1/10 	€ 13,00

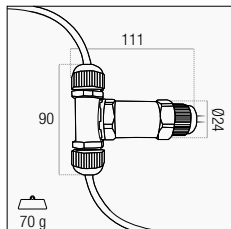

T 3 VIE / T 3 WAY

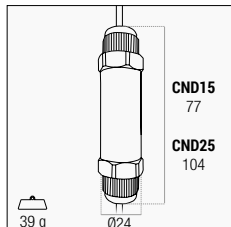

		CAVI / CABLE	SEZIONE / SECTION			
IP68	MAX 450 V 24 A	Ø 4 mm - Ø 12 mm	3 x 1,5 mm <sup>2</sup>	<b>CNT</b>	1/10 	€ 10,00

LINEARE 2 VIE / LINEAR 2 WAY



		CAVI / CABLE	SEZIONE / SECTION			
IP68	MAX 450 V 13 A	Ø 4 mm - Ø 10 mm	3 x 1,5 mm <sup>2</sup>	<b>CND15</b>	1/10 	€ 6,50
	MAX 450 V 24 A	Ø 4 mm - Ø 12 mm	3 x 2,5 mm <sup>2</sup>	<b>CND25</b>	1/10 	€ 7,50





OUTDOOR  
OUTDOOR  
**OUTDOOR**  
OUTDOOR  
OUTDOOR

SOLARI  
SOLARI  
**SOLARI**  
SOLARI  
SOLARI

SOLAR  
SOLAR  
**SOLAR**  
SOLAR  
SOLAR





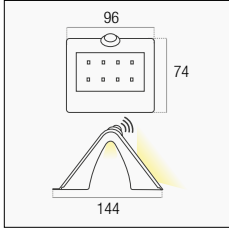

3-4 m 208 g 120° - 2x6 m

1,5 W 220 lm 120° ∠ Li-Ion 3,7 V/DC 1.200 mAh*	Bianco / White ○	Color Box 4000K	<b>ACSB-151240</b>	6/24	€ 25,00
		Blister 4000K	<b>ACSBL-151240BL</b>	4/16	€ 25,00
	Argento / Silver ●	Color Box 4000K	<b>ACSS-151240</b>	6/24	€ 25,00
		Blister 4000K	<b>ACSSL-151240BL</b>	4/16	€ 25,00

Ricarica in 4~6 h / Autonomia fino a 12~16 h  
Recharge in 4~6 h / Autonomy up to 12~16 h

### Modalità crepuscolare con sensore PIR / Twilight with PIR sensor modes



MODE 1

Dopo il tramonto, ON automatico, 100% al passaggio, stand by al 10% dopo 10 secondi in biemissione

Automatic ON at sunset, 100% at PIR detection, back to 10% after 10 seconds front and backlight



MODE 2

Dopo il tramonto, ON automatico, 100% al passaggio, stand by al 3% dopo 10 secondi in emissione posteriore

Automatic ON at sunset, 100% at PIR detection, back to 3% after 10 seconds only backlight

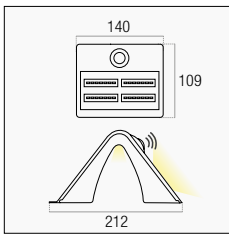

3-4 m 450 g 120° - 2x6 m

3,2 W 400 lm 60° - 120° ∠ Li-Ion 3,7 V/DC 2.000 mAh*	Bianco / White ○	Color Box 4000K	<b>ACSB-321240</b>	1/12	€ 50,00
	Argento / Silver ●	Color Box 4000K	<b>ACSS-321240</b>		

Ricarica in 4~6 h / Autonomia fino a 12~16 h  
Recharge in 4~6 h / Autonomy up to 12~16 h

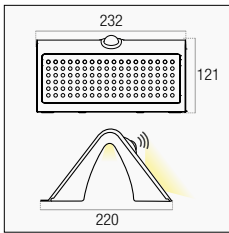

2-4 m 980 g 120° - 2x7 m

8 W 850 lm 90° ∠ 2 x Li-Ion 3,7 V/DC 2.000 mAh*	Bianco / White ○	Color Box 4000K	<b>ACSB-681240 UPGRADE</b>	1/8	€ 89,00
---	------------------	-----------------	----------------------------	-----	---------

Ricarica in 4~6 h / Autonomia fino a 12~16 h  
Recharge in 4~6 h / Autonomy up to 12~16 h

New design  
Better performance

### Modalità crepuscolare e con sensore PIR / Twilight and PIR sensor modes



MODE 1

ON automatico al 20% al tramonto per 5 ore

Automatic ON at 20% at sunset for 5 hours



MODE 2

Dopo il tramonto, ON automatico, 100% al passaggio, stand by al 3% dopo 20 secondi

Automatic ON at sunset, 100% at PIR detection, back to 3% after 20 seconds



MODE 3

Dopo il tramonto, ON automatico, 100% al passaggio, OFF dopo 30 secondi

Automatic ON at sunset, 100% at PIR detection, OFF after 30 seconds

Applique solare a doppia emissione.  
Corpo in PBT (polibutilentereftalato) resistente agli urti. Batterie 18650 sostituibili.

Double emission solar wall light.  
Impact resistant PBT body.  
Replaceable 18650 batteries.



\*1 anno di garanzia / 1 year warranty  
RICAMBIO BATTERIA / BATTERY REPLACEMENT  
Li-Ion 3,7 V/DC

1.200 mAh	<b>RBACS-15</b>	1/1	€ 4,30
2.000 mAh	<b>RBACS-3268</b>	1/1	€ 7,70



CAVO DA 2 METRI / 2 METER CABLE

MAGNETICO / MAGNETIC



# SOLAR GENIUS



Pannello fotovoltaico separabile  
Separable photovoltaic panel



7 modalità di installazione  
7 installation modes



Sensore PIR di movimento  
PIR motion sensor



Resistente all'acqua  
Waterproof

7in1



A muro con pannello  
Integrated wall mount



A muro separato  
Split wall mount



Agganciato  
Hanging



Tramite magnete  
With magnet



Portatile  
Portable



Da tavolo  
Standalone



Tramite adesivo  
Stick-On



**NEW**

SOLARI

# GENIUS



Pannello fotovoltaico con funzione crepuscolare separabile  
Detachable photovoltaic panel with twilight sensor

OUTDOOR

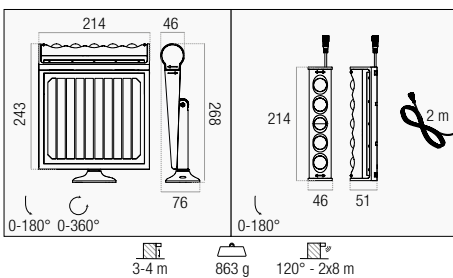

8W	950 lm	120° ∠	Li-Ion 3,7 V/DC 4.000 mAh*	4000K	<b>GNS-081240 NEW</b>	1/12	€ 93,50
Ricarica ~6 h / Autonomia fino a ~15 h Recharge ~6 h / Autonomy up to ~15 h						Batteria sostituibile Replaceable battery	

## Modalità luminosa / Bright modes

**MODE 1** ☀ > 30%

Dopo il tramonto, ON automatico, 100% al passaggio, in modalità ridotta dopo 20 secondi

Automatic ON at sunset, 100% at PIR detection, stand by mode after 20 seconds

**MODE 1** ☀ < 30%

Dopo il tramonto, ON automatico, 100% al passaggio, OFF dopo 20 secondi

Automatic ON at sunset, 100% at PIR detection, OFF after 20 seconds

**MODE 2**

ON al 100% al tramonto, in modalità ridotta dopo 5 ore

ON at 100% at sunset, stand by mode after 5 hours

Proiettore solare con pannello fotovoltaico separabile. Installazione estremamente versatile grazie alle sue 7 modalità di utilizzo.

Solar projector with separable photovoltaic panel. Extremely versatile thanks to its 7 installation modes.



\*1 anno di garanzia / 1 year warranty  
RICAMBIO BATTERIA / BATTERY REPLACEMENT  
Li-Ion 3,7 V/DC

4.000 mAh	<b>RBGNS NEW</b>	1/1	€ 19,00
-----------	------------------	-----	---------





**NEW**

SOLARI

# SIRIO SOLAR



	A mm	B mm	C mm	D mm	g
50 W	177	122	180	220	873
100 W	222	160	235	350	1461
200 W	289	207	350	350	2308

2,5 W = 50 W	400 lm	90° ∠	Li-Ion 3,7 V/DC 5.000 mAh*	4000K	<b>SRSOL-509040 NEW</b>	1/10	€ 86,00
5 W = 100 W	800 lm	90° ∠	LiFePO4 3,2 V/DC 10.000 mAh*	4000K	<b>SRSOL-1009040 NEW</b>	1/5	€ 118,00
10 W = 200W	1.800 lm	90° ∠	LiFePO4 3,2 V/DC 20.000 mAh*	4000K	<b>SRSOL-2009040 NEW</b>	1/5	€ 166,00

Ricarica ~5-8 h / Autonomia fino a ~10-12 h  
 Recharge ~5-8 h / Autonomy up to ~10-12 h



Proiettore solare con pannello fotovoltaico e funzione crepuscolare. Corpo in alluminio pressofuso e scocca in plastica anti-urto.

Solar wall light with photovoltaic panel and twilight sensor. Die-cast aluminum body, shockproof plastic shell.



Telecomando multifunzione incluso per accensione e spegnimento, regolazione intensità luminosa e impostazione timer

Remote controller included for switching ON/OFF, light dimming and timer setting

\*1 anno di garanzia / 1 year warranty

**NEW**

SOLARI

# DOMINO



OUTDOOR

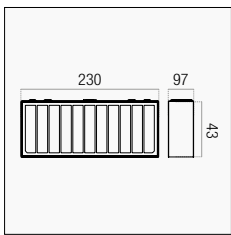

3-4 m 580 g 120° - 2x6 m

6 W 800 lm 70°x140° ∠ Li-Ion 3,7 V/DC 4.000 mAh*	Bianco / White ○	3000K	<b>DOMBI-061230 NEW</b>	1/12	€ 65,00
	Nero / Black ●	4000K	<b>DOMBI-061240 NEW</b>		
		3000K	<b>DOMNE-061230 NEW</b>		
	4000K	<b>DOMNE-061240 NEW</b>			

Ricarica ~5-6 h / Autonomia fino a ~15 h  
Recharge ~5-6 h / Autonomy up to ~15 h

## Modalità luminosa / Bright modes



**MODE 1** ☀ > 30%  
Dopo il tramonto, ON automatico,  
100% al passaggio, in modalità ridotta dopo 20 secondi

Automatic ON at sunset, 100% at PIR detection,  
stand by mode after 20 seconds



**MODE 1** ☀ < 30%  
Dopo il tramonto, ON automatico,  
100% al passaggio, OFF dopo 20 secondi

Automatic ON at sunset, 100% at PIR detection,  
OFF after 20 seconds



**MODE 2**  
ON al 50% al tramonto,  
in modalità ridotta dopo 5 ore

ON at 50% at sunset,  
stand by mode after 5 hours

Applique solare con pannello fotovoltaico, sensore crepuscolare e sensore PIR di movimento. Forma adatta ad installazioni pratiche e discrete.

Solar wall light with photovoltaic panel, twilight sensor and PIR motion sensor. Nice shape for practical and discreet installations.



Pannello fotovoltaico con sensore crepuscolare integrato  
Photovoltaic panel with twilight sensor integrated

\*1 anno di garanzia / 1 year warranty

**RICAMBIO BATTERIA / BATTERY REPLACEMENT**  
Li-Ion 3,7 V/DC



4.000 mAh	<b>RBDOM NEW</b>	1/100	€ 8,50
-----------	------------------	-------	--------



SOLARI

# DVERSO



Doppia modalità di funzione  
Double function mode

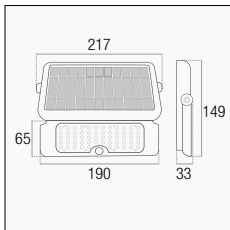

3-4 m 713 g 120° - 2x6 m

5 W	500 lm	90° ∠	Li-Ion 3,7 V/DC 3.000 mAh*	4000K	<b>DVS-059040</b>	1/12	€ 56,00
-----	--------	-------	----------------------------	-------	-------------------	------	---------

Ricarica ~6 h / Autonomia fino a ~12 h  
Recharge ~6 h / Autonomy up to ~12 h

### Modalità luminosa / Bright modes



**MODE 1** > 30%

Dopo il tramonto, ON automatico, 100% al passaggio, in modalità ridotta dopo 20 secondi

Automatic ON at sunset, 100% at PIR detection, stand by mode after 20 seconds



**MODE 1** < 30%

Dopo il tramonto, ON automatico, 100% al passaggio, OFF dopo 20 secondi

Automatic ON at sunset, 100% at PIR detection, OFF after 20 seconds



**MODE 2**

ON al 100% al tramonto, in modalità ridotta dopo 5 ore

ON at 100% at sunset, stand by mode after 5 hours



Staffa ruotabile 360° - Pannello regolabile 135°  
360° Rotatable bracket - 135° Adjustable panel



Installazione a parete o su superficie piana  
Wall or flat surface installation

Proiettore solare LED progettato per sfruttare al massimo l'energia del sole e generare una luce di alta qualità. Consente di annullare totalmente i costi energetici.

LED solar floodlight designed to get the maximum energy from the sun and produce high quality light. A good solution to save energy costs.



**RICAMBIO BATTERIA / BATTERY REPLACEMENT**  
\*1 anno di garanzia / 1 year warranty

Li-Ion 3,7 V/DC	7.200 mAh	<b>RBDVS-05</b>	1/100	€ 15,00
-----------------	-----------	-----------------	-------	---------

SOLARI

# DVERSO



Tripla modalità di funzione  
Triple function mode

Adatto per pali da Ø 40-60 mm  
Suitable for Ø 40-60 mm poles

OUTDOOR

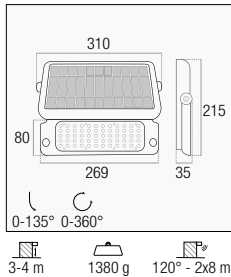

10 W	1.080 lm	90° ∠	Li-Ion 3,7 V/DC 7.200 mAh*	4000K	<b>DVS-109040</b>	1/12	€ 103,00
------	----------	-------	----------------------------	-------	-------------------	------	----------

Ricarica ~6 h / Autonomia fino a ~20 h  
Recharge ~6 h / Autonomy up to ~20 h

3-4 m 1380 g 120° - 2x8 m

### Modalità luminosa / Bright modes



Staffa ruotabile 360° - Pannello regolabile 135°  
360° Rotatable bracket - 135° Adjustable panel



**MODE 1** > 30%

Dopo il tramonto, ON automatico, 100% al passaggio, in modalità ridotta dopo 20 secondi

Automatic ON at sunset, 100% at PIR detection, stand by mode after 20 seconds



**MODE 1** < 30%

Dopo il tramonto, ON automatico, 100% al passaggio, OFF dopo 20 secondi

Automatic ON at sunset, 100% at PIR detection, OFF after 20 seconds



**MODE 2**

ON al 100% al tramonto, in modalità ridotta dopo 5 ore

ON at 100% at sunset, stand by mode after 5 hours



Installazione a muro o a palo tramite staffa inclusa  
Wall or pole installation using the included bracket

Proiettore solare LED progettato per sfruttare al massimo l'energia del sole e generare una luce di alta qualità. Consente di annullare totalmente i costi energetici.

LED solar floodlight designed to get the maximum energy from the sun and produce high quality light. A good solution to save energy costs.



### RICAMBIO BATTERIA / BATTERY REPLACEMENT \*1 anno di garanzia / 1 year warranty

Li-Ion 3,7 V/DC	3.000 mAh	<b>RBDVS</b>	1/100	€ 30,00
	7.200 mAh	<b>RBDVS-05</b>	1/100	€ 15,00









# LEVANTE

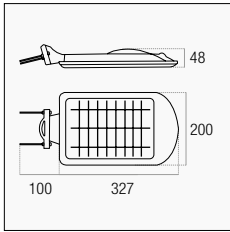

2-4 m 1100 g 120° 5-10 m

5 W	500 lm	120° ∠	LiFePO4 6,4 V/DC 3000 mAh*	4000K	<b>LVT-059540</b>	1/5	€ 166,00
-----	--------	--------	----------------------------	-------	-------------------	-----	----------

Ricarica ~6 h / Autonomia fino a ~8 h  
Recharge ~6 h / Autonomy up to ~8 h

5W adatto per pali da Ø 20-60 mm  
5W suitable for Ø 20-60 mm poles

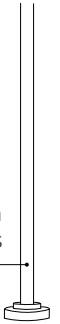

## Funzionamento / Operation



**STEP 1**  
ON automatico al tramonto in modalità ridotta di intensità  
Automatic ON at sunset in low intensity mode



**STEP 2**  
ON al 100% al rilevamento, in modalità ridotta dopo 45 secondi  
100% at PIR detection, to low intensity mode after 45 seconds

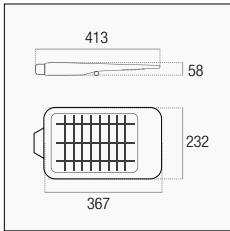

3-5 m 1660 g 120° 5-8 m

15 W	1.600 lm	140° ∠	LiFePO4 7,4 V/DC 5400 mAh*	4000K	<b>LVT-159540</b>	1/10	€ 118,00
------	----------	--------	----------------------------	-------	-------------------	------	----------

Ricarica ~6 h / Autonomia fino a ~8 h  
Recharge ~6 h / Autonomy up to ~8 h

15W adatto per pali da Ø 40-60 mm  
15W suitable for Ø 40-60 mm poles

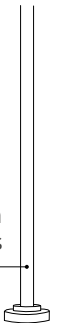

## Modalità luminosa / Bright modes



**MODE 1**  
ON automatico al tramonto in modalità ridotta,  
OFF all'alba  
Automatic ON at sunset in low intensity mode,  
OFF at sunrise



**MODE 2** > 30%  
ON automatico al tramonto, 100% al passaggio,  
in modalità ridotta dopo 20 secondi  
Automatic ON at sunset, 100% at PIR detection,  
to low intensity mode after 20 seconds



**MODE 2** < 30%  
ON automatico al tramonto, 100% al passaggio,  
in modalità ridotta dopo 20 secondi, OFF dopo 5 minuti  
Automatic ON at sunset, 100% at PIR detection,  
in low intensity after 20 seconds, OFF after 5 minutes

## Modalità di installazione / Installation modes



**PALO DRITTO / STRAIGHT POLE**  
Staffa a U per pali da Ø40-60 mm inclusa,  
U-bracket for Ø40-60 mm poles included

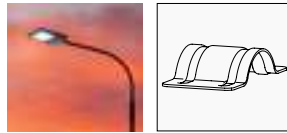

**PALO OBLIQUO / OBLIQUE POLE**  
Staffa curva per pali da Ø40-50 mm inclusa  
Curved bracket for Ø40-50 mm poles included



**MURO / WALL**  
Staffa per fissaggio a muro inclusa  
Wall fixing bracket included

## RICAMBIO ATTACCO PALO / SPARE POLE MOUNT



Ø 40 - 60 mm	<b>ATPLVT</b>	1/24	€ 19,00
--------------	---------------	------	---------

Lampione fotovoltaico progettato per sfruttare al massimo l'energia del sole e generare una luce di alta qualità. Palo non incluso. Batteria sostituibile, accensione switch power.

Photovoltaic lamp designed to get the maximum energy from the sun and produce high quality light. Pole not included. Replaceable battery, power switch ignition.



\*1 anno di garanzia / 1 year warranty

<b>RICAMBIO BATTERIA 15 W / BATTERY REPLACEMENT 15W</b>			
LiFePO4 7,4V 5.400 mAh	<b>RBLVT</b>	1/1	€ 43,00



OUTDOOR  
OUTDOOR  
**OUTDOOR**  
OUTDOOR  
OUTDOOR

DECORATIVO  
DECORATIVO  
**DECORATIVO**  
DECORATIVO  
DECORATIVO

DECORATIVE  
DECORATIVE  
**DECORATIVE**  
DECORATIVE  
DECORATIVE



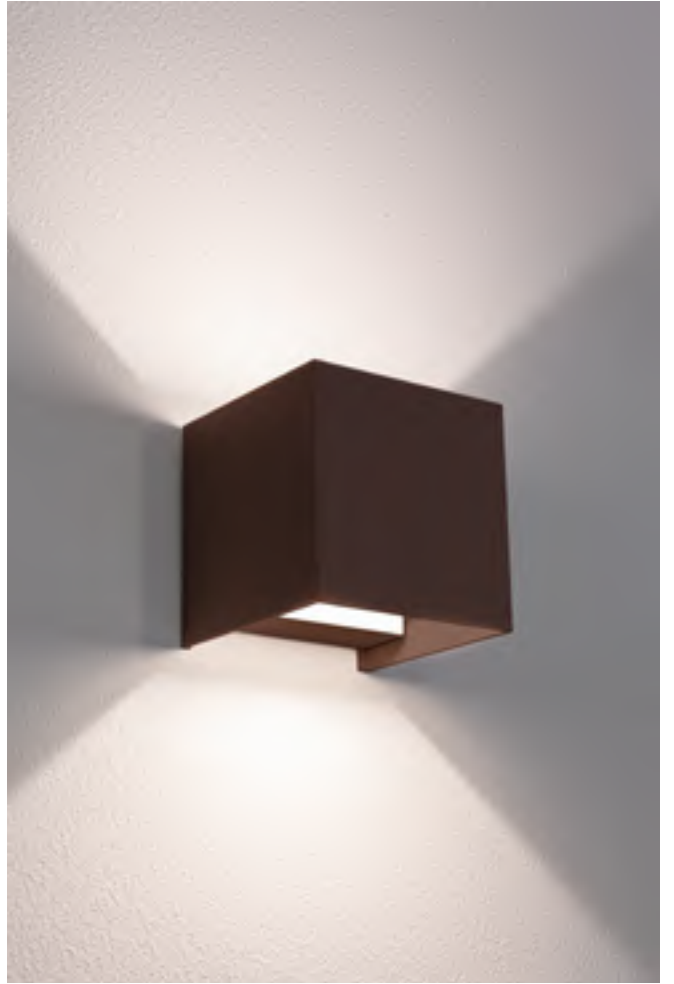

**NEW**

OUTDOOR - DECORATIVO

# UP&DOWN +

## SQUARE

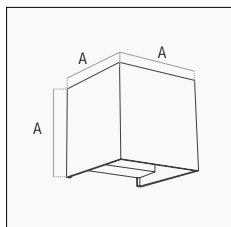

	A mm	g
10 W	100	620
20 W	120	980

10 W	800 lm	7° - 100°	Bianco / White ○ CCT 3000K - 4000K - 5500K	<b>UDSBI-1010 NEW</b>	6/18	€ 53,00
			Ruggine / Corten ● CCT 3000K - 4000K - 5500K	<b>UDSCO-1010 NEW</b>		
			Grigio / Grey ● CCT 3000K - 4000K - 5500K	<b>UDSGR-1010 NEW</b>		
			Nero / Black ● CCT 3000K - 4000K - 5500K	<b>UDSNE-1010 NEW</b>		
20 W	1.800 lm	7° - 100°	Bianco / White ○ CCT 3000K - 4000K - 5500K	<b>UDSBI-2012 NEW</b>	6/18	€ 82,00
			Ruggine / Corten ● CCT 3000K - 4000K - 5500K	<b>UDSCO-2012 NEW</b>		
			Grigio / Grey ● CCT 3000K - 4000K - 5500K	<b>UDSGR-2012 NEW</b>		
			Nero / Black ● CCT 3000K - 4000K - 5500K	<b>UDSNE-2012 NEW</b>		



## ROUND

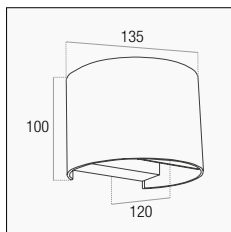

640 g

10 W	800 lm	7° - 100°	Bianco / White ○ CCT 3000K - 4000K - 5500K	<b>UDRBI-1010 NEW</b>	6/18	€ 53,00
			Ruggine / Corten ● CCT 3000K - 4000K - 5500K	<b>UDRCO-1010 NEW</b>		
			Grigio / Grey ● CCT 3000K - 4000K - 5500K	<b>UDRGR-1010 NEW</b>		
			Nero / Black ● CCT 3000K - 4000K - 5500K	<b>UDRNE-1010 NEW</b>		



OUTDOOR

Alette regolabili singolarmente / Individually adjustable flaps

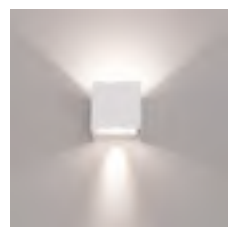
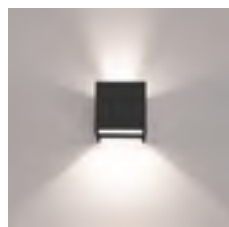
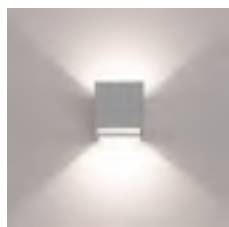
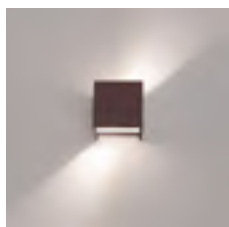
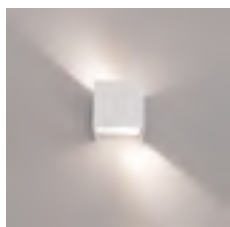

Applique di design in alluminio con fascio luminoso bidirezionale, alette regolabili singolarmente per personalizzare ogni ambiente esterno.

Elegant aluminum wall applique with bidirectional light beam, by adjustable fins to customize any outdoor ambience.

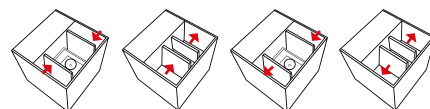

Alette indipendenti regolabili da 7° a 100°  
Independent flaps adjustable from 7° to 100°



OUTDOOR - DECORATIVO

# UP&DOWN

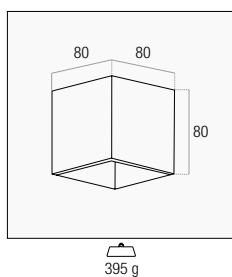
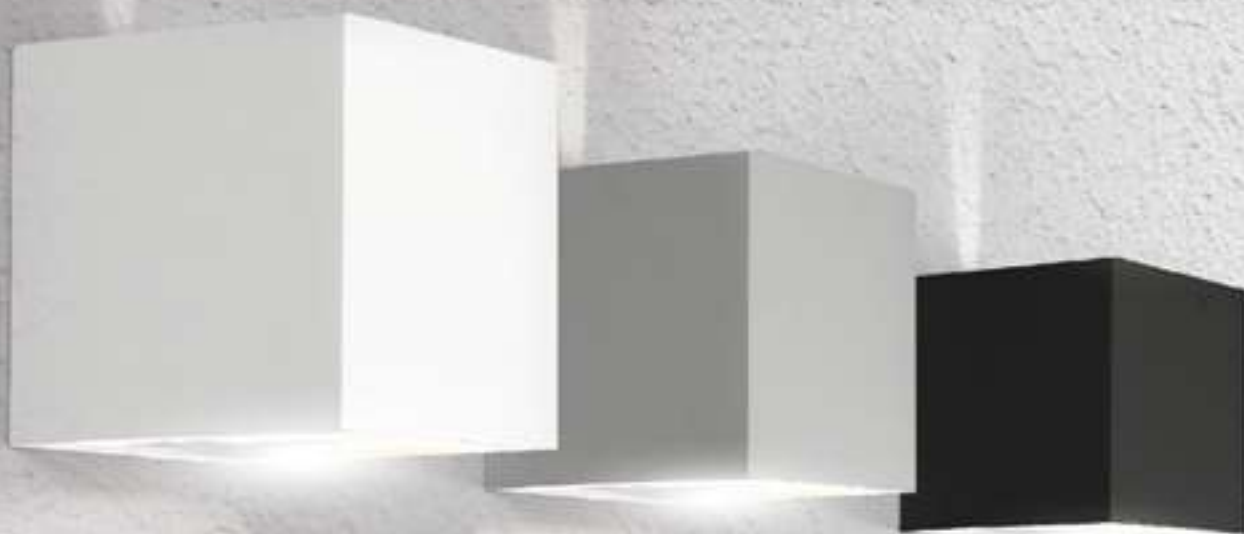

6 W    550 lm    7° - 100° ∠	Bianco / White ○	3000K	<b>UDBI-068030</b>	10/20	€ 58,00
		4000K	<b>UDBI-068040</b>		
	Grigio / Grey ●	3000K	<b>UDGR-068030</b>		
		4000K	<b>UDGR-068040</b>		
	Nero / Black ●	3000K	<b>UDNE-068030</b>		
		4000K	<b>UDNE-068040</b>		

Applique di design in alluminio con fascio luminoso bidirezionale, regolabile tramite alette.

Elegant aluminum wall lamp with bidirectional light beam by adjustable fins.

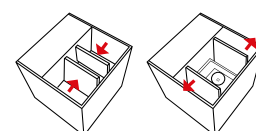

Alette regolabili da 7° a 100°  
Adjustable fins from 7° to 100°

OUTDOOR - DECORATIVO

# FORMA

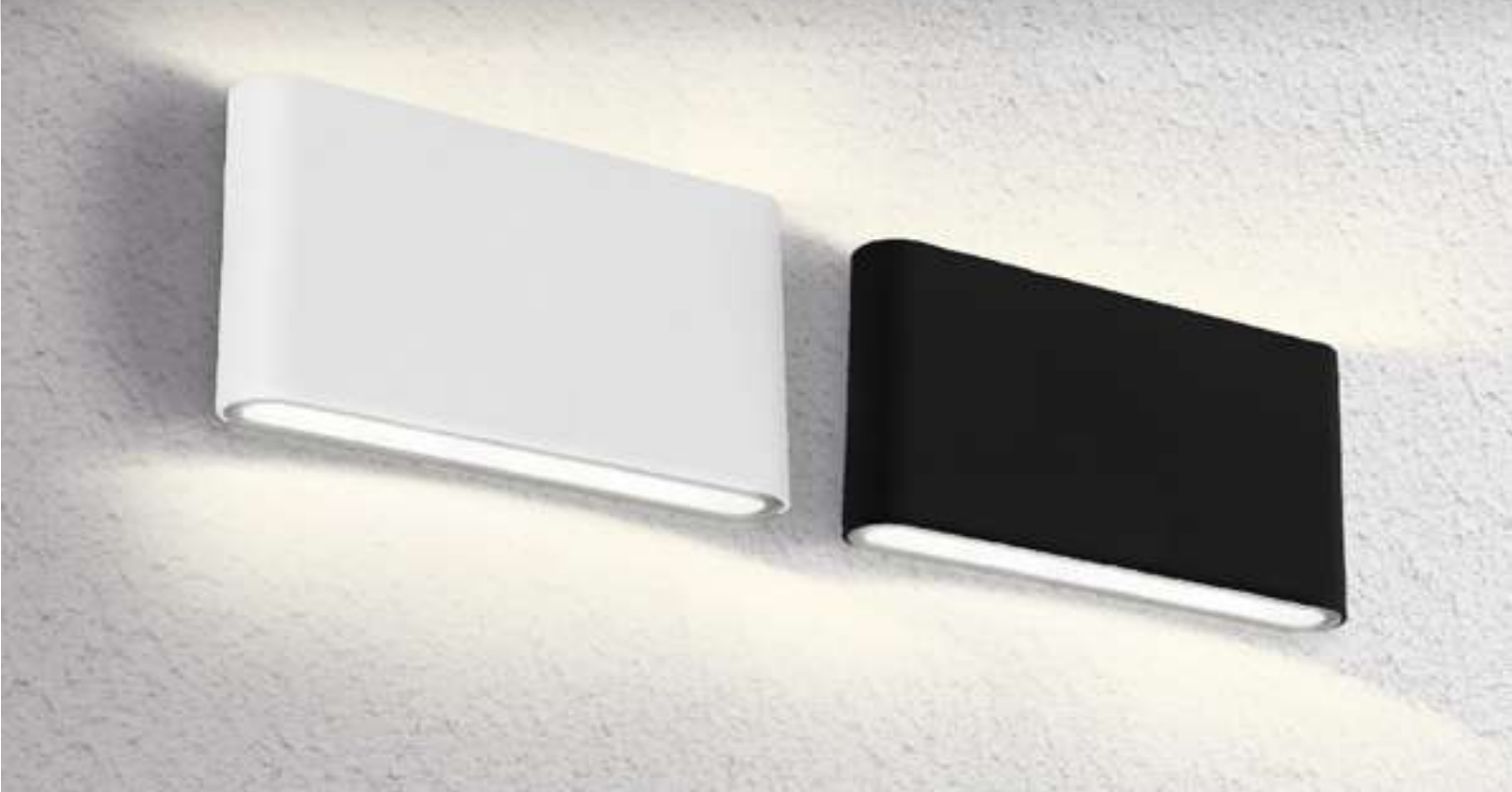

OUTDOOR

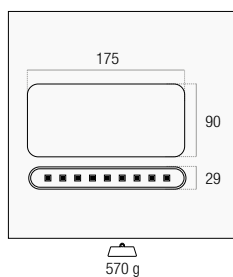

12 W	820 lm	120° ∠	Bianco / White ○	3000K	<b>FRMB-129030</b>	6/18	€ 48,00
				4000K	<b>FRMB-129040</b>		
			Nero / Black ●	3000K	<b>FRMN-129030</b>		
				4000K	<b>FRMN-129040</b>		

Applique bidirezionale dal design moderno ed esclusivo. Produce un'illuminazione decorativa tramite effetto diffondente su parete.

Bidirectional wall lamp with a modern and exclusive design. Especially for decorative lighting through a diffusing effect on the wall.



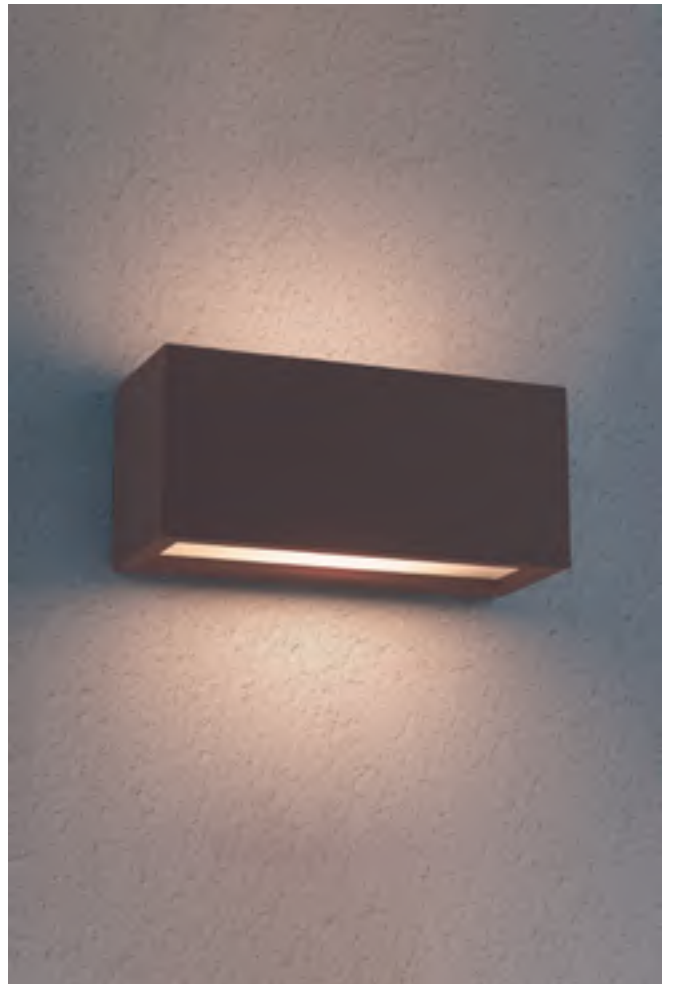

**NEW**

OUTDOOR - DECORATIVO

# REVERSO

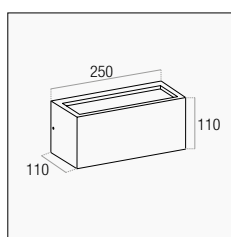

890 g

1 x E27	Bianco / White ○	<b>RVBI-E27 NEW</b>	1/6	€ 60,00
	Ruggine / Corten ●	<b>RVCO-E27 NEW</b>		
	Grigio / Grey ●	<b>RVGR-E27 NEW</b>		
	Nero / Black ●	<b>RVNE-E27 NEW</b>		

Luce bidirezionale  
Bi-directional light

Moderna applique in alluminio a doppia emissione luminosa. Installabile in ambienti esterni. Compatibile con lampade E27.

Modern aluminum applique with double light output. Suitable for outdoor ambiances. Compatible with E27 lamps.



E27

Non inclusa / Not included  
Vedi / Ref.

ING3-082727



AXO-1GU10B

AXO-1GU10SC



AXO-2GU10G

AXO-2GU10SN





**NEW**

OUTDOOR - DECORATIVO

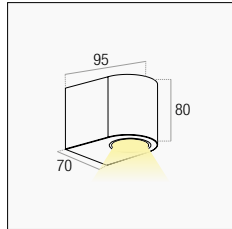
**AXO**

350 g

1 x GU10	Bianco / White ○	<b>AXO-1GU10B</b>	12/24	€ 20,00
	Ruggine / Corten ●	<b>AXO-1GU10C NEW</b>		
	Grigio / Grey ●	<b>AXO-1GU10G NEW</b>		
	Nero / Black ●	<b>AXO-1GU10N NEW</b>		

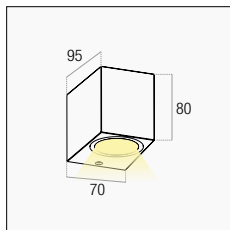
Luce monodirezionale  
One-way light

370 g

1 x GU10	Bianco / White ○	<b>AXO-1GU10SB NEW</b>	12/24	€ 23,00
	Ruggine / Corten ●	<b>AXO-1GU10SC NEW</b>		
	Grigio / Grey ●	<b>AXO-1GU10SG NEW</b>		
	Nero / Black ●	<b>AXO-1GU10SN NEW</b>		

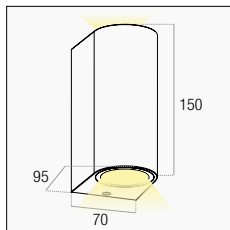
Luce monodirezionale  
One-way light

550 g

2 x GU10	Bianco / White ○	<b>AXO-2GU10B</b>	12/24	€ 29,00
	Ruggine / Corten ●	<b>AXO-2GU10C NEW</b>		
	Grigio / Grey ●	<b>AXO-2GU10G NEW</b>		
	Nero / Black ●	<b>AXO-2GU10N NEW</b>		

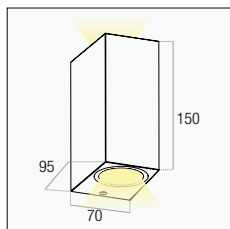
Luce bidirezionale  
Bi-directional light

570 g

2 x GU10	Bianco / White ○	<b>AXO-2GU10SB NEW</b>	12/24	€ 31,00
	Ruggine / Corten ●	<b>AXO-2GU10SC NEW</b>		
	Grigio / Grey ●	<b>AXO-2GU10SG NEW</b>		
	Nero / Black ●	<b>AXO-2GU10SN NEW</b>		

Luce bidirezionale  
Bi-directional light

Moderne applique in alluminio a singola o doppia emissione luminosa. Diffusore in vetro.

Modern aluminum applique with single or double light output. Glass diffuser.



GU10

Non inclusa / Not included  
Vedi / Ref.

LEXAR 6W / 8W

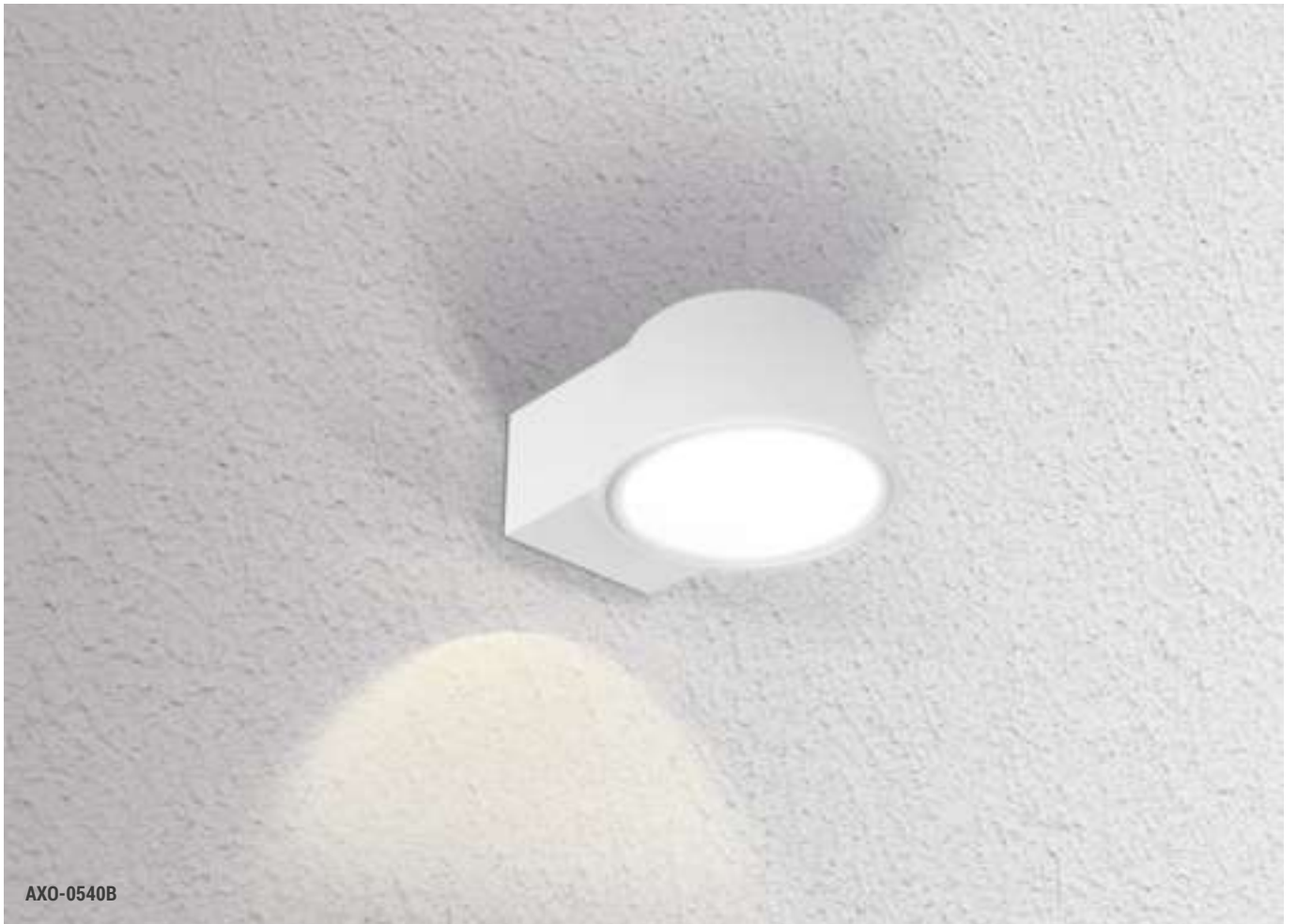

AXO-0540B



AXO-109030

AXO-209030

# AXO

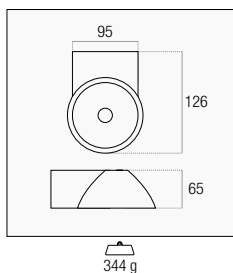

5 W	350 lm	120° ∠	3000K	<b>AXO-0540B</b>	12/24	€ 38,00
-----	--------	--------	-------	------------------	-------	---------

Chip integrato  
Integrated chip

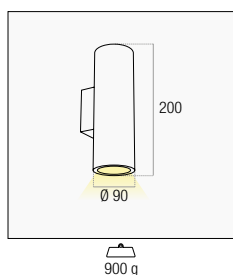

10 W	800 lm	36° ∠	3000K	<b>AXO-109030</b>	1/6	€ 65,00
			4000K	<b>AXO-109040</b>		

Luce monodirezionale  
One-way light

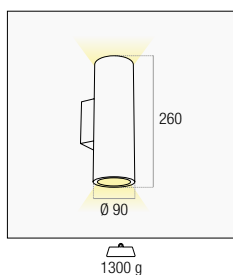

20 W	1600 lm	36° ∠	3000K	<b>AXO-209030</b>	1/6	€ 77,00
------	---------	-------	-------	-------------------	-----	---------

Luce bidirezionale  
Bi-directional light

Appliche mono o bidirezionali, dal design moderno. Effetto taglio di luce sulle pareti. Corpo in alluminio pressofuso, vetro temperato, guarnizioni in silicone, viti in acciaio inox.

Mono or bidirectional applique, with a modern design. Light cut effect on the walls. Die-cast aluminum body, tempered glass, silicone gaskets, stainless steel screws.

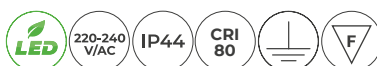

Ideale per portici, ingressi e ambienti esterni  
Ideal for porches, entrances and outdoor ambiances





**NEW**

OUTDOOR - SEGNAPASSO

# PASEO

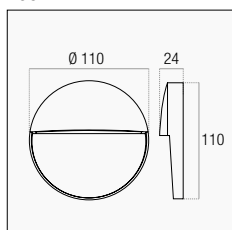
**ROUND**

180 g

4 W	400 lm	78° ∠	Bianco / White ○ 4000K	<b>PEOBIR-041140 NEW</b>	1/25	€ 32,00
			Ruggine / Corten ● 4000K	<b>PEOCOR-041140 NEW</b>		
			Grigio / Grey ● 4000K	<b>PEOGR-041140 NEW</b>		
			Nero / Black ● 4000K	<b>PEONER-041140 NEW</b>		

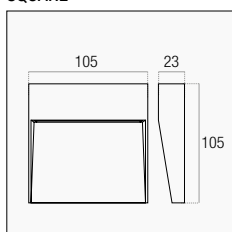
**SQUARE**

220 g

4 W	400 lm	94° ∠	Bianco / White ○ 4000K	<b>PEOBIS-041140 NEW</b>	1/25	€ 32,00
			Ruggine / Corten ● 4000K	<b>PEOCOS-041140 NEW</b>		
			Grigio / Grey ● 4000K	<b>PEOGS-041140 NEW</b>		
			Nero / Black ● 4000K	<b>PEONES-041140 NEW</b>		



Applique segnapasso dal design moderno. Corpo in alluminio pressofuso in 4 finiture.

Path marker applique with a modern design. Die-cast aluminum body in 4 finishes.





OUTDOOR - SEGNAPASSO

# CORTÈS

EMERG.  
3h

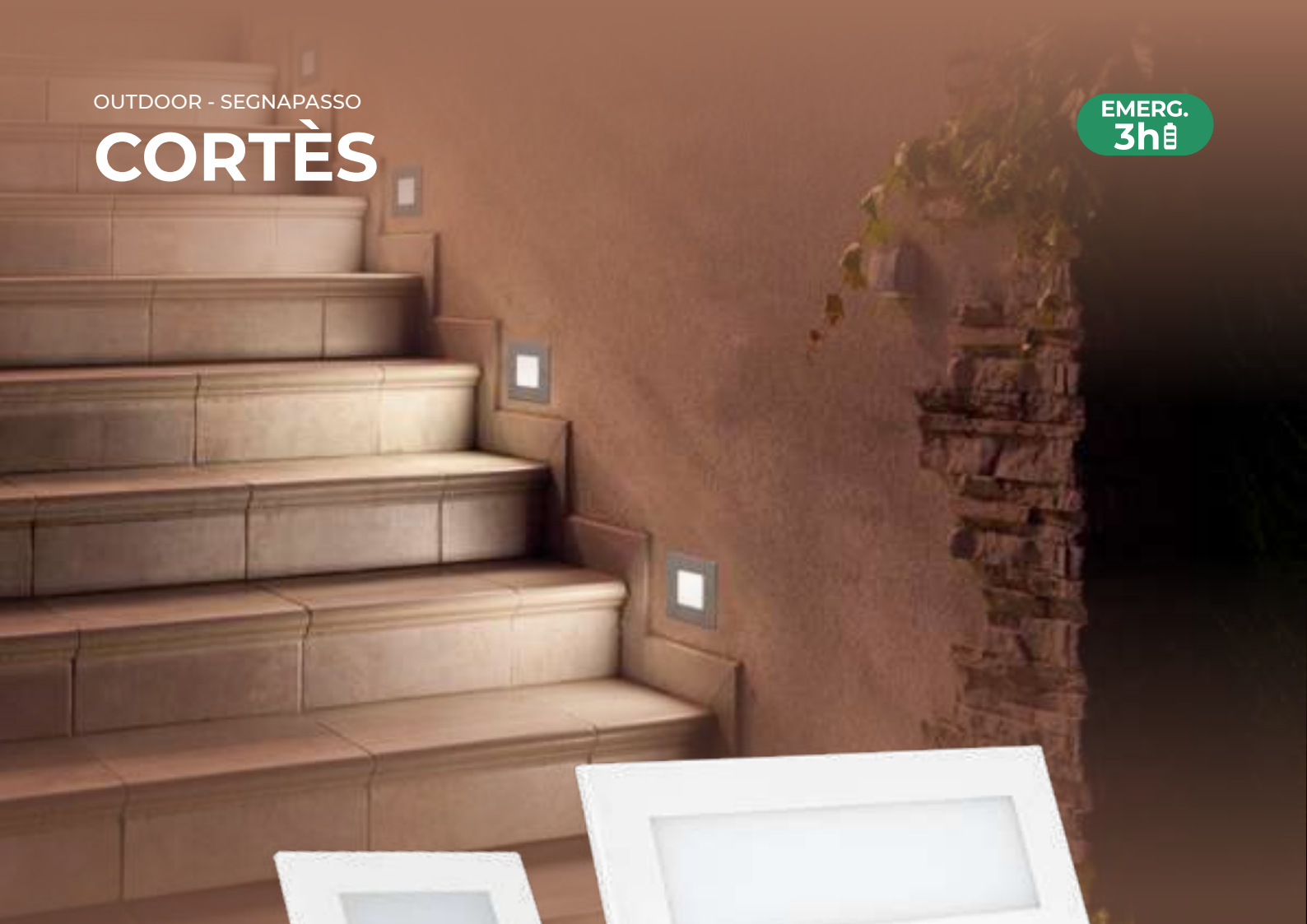

CRT3



CRT6

	A mm	B mm	C mm	g
CRT3	107	25	68	63
CRT3E	107	45	68	126
CRT6	180	47	82	192
CRT6E	180	49	80	198

1 W	70 lm	-	IP65	Cover ○+○	4000K	<b>CRT3-014000</b>	1/40	€ 26,00
		3h Emerg.	IP20	Cover ○+○	4000K	<b>CRT3E-010340</b>	1/40	€ 60,00
5 W	280 lm	-	IP65	Cover ○+○	4000K	<b>CRT6-054000</b>	1/50	€ 59,00
		3h Emerg.	IP65	Cover ○+○	4000K	<b>CRT6E-050340</b>	1/50	€ 83,00



Perfetta per scatole 503 (CRT3) e 506 (CRT6)  
Perfect for 503 (CRT3) and 506 (CRT6) boxes



Cover in metallo satinato intercambiabile inclusa  
Interchangeable satin metal cover included

Luce segnapasso da incasso. Variante con sistema di emergenza che si accende in mancanza di corrente elettrica.

Recessed steplight light. Emergency system version that turns on in case of a power failure.







# LUME PLUS

La soluzione senza fili per l'illuminazione d'atmosfera.  
The wireless solution for evocative lighting.



Autonomia  
Autonomy



Luce bidirezionale  
Bi-directional light



Ricaricabile  
Rechargeable



Per interni ed esterni  
For indoors and outdoors

**NEW**

OUTDOOR - DECORATIVO

# LUME PLUS

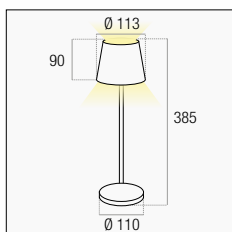

812 g



Cavo di ricarica USB Type-C incluso  
USB Type-C charging cable included

Elegante lampada da tavolo LED ricaricabile. Maneggevole e stabile grazie alla base antiscivolo. Tasto di controllo touch per regolazione intensità luminosa.

Elegant rechargeable LED table lamp. Easy to handle and stable thanks to non-slip base. Touch control button for light intensity adjustment.



2,2 W	190 lm	Li-Ion 3,7 V/DC 5.000 mAh*	Bianco / White ○ 2700K	<b>LMPB-023827 NEW</b>	1/9	€ 86,00
			Ruggine / Corten ● 2700K	<b>LMPC-023827 NEW</b>		
			Nero / Black ● 2700K	<b>LMPN-023827 NEW</b>		

Ricarica ~3,5 h / Autonomia ~12 h  
Recharge ~3,5 h / Autonomy ~12 h

Doppia emissione luminosa  
Double light emission



ESPOSITORE LUME PLUS /  
LUME PLUS EXHIBITOR

**EXPO-LUME NEW** 1/1

PAG. 378



Utilizzo del pulsante posto sulla sommità della lampada  
TAP: Accensione e spegnimento  
PRESS: Regolazione dell'intensità luminosa

Use of the button located on the top of the lamp  
TAP: Power on and off  
PRESS: Adjustment of light intensity

\*1 anno di garanzia / 1 year warranty





INDOOR  
INDOOR  
**INDOOR**  
INDOOR  
INDOOR

DECORATIVO  
DECORATIVO  
**DECORATIVO**  
DECORATIVO  
DECORATIVO

DECORATIVE  
DECORATIVE  
**DECORATIVE**  
DECORATIVE  
DECORATIVE

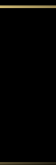



QUBE



RONDÒ

# QUBE - RONDÒ

QUBE

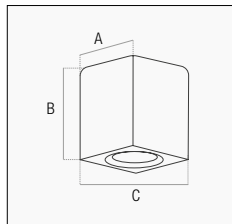

	A mm	B mm	C mm	g
10 W	90	90	90	388
15 W	112	123	112	610
25 W	131	134	131	950
35 W	161	164	161	1476

10 W	800 lm	Bianco / White ○	3000K	<b>QBBI-109030</b>	6/24	€ 37,00
			4000K	<b>QBBI-109040</b>		
		Nero / Black ●	3000K	<b>QBNE-109030</b>		
			4000K	<b>QBNE-109040</b>		
15 W	1.350 lm	Bianco / White ○	3000K	<b>QBBI-1511230</b>	6/24	€ 62,00
			4000K	<b>QBBI-1511240</b>		
		Nero / Black ●	3000K	<b>QBNE-1511230</b>		
			4000K	<b>QBNE-1511240</b>		
25 W	2.500 lm	Bianco / White ○	3000K	<b>QBBI-2513130</b>	6/24	€ 89,00
			4000K	<b>QBBI-2513140</b>		
		Nero / Black ●	3000K	<b>QBNE-2513130</b>		
			4000K	<b>QBNE-2513140</b>		
35 W	3.675 lm	Bianco / White ○	3000K	<b>QBBI-3516130</b>	6/12	€ 118,00
			4000K	<b>QBBI-3516140</b>		
		Nero / Black ●	3000K	<b>QBNE-3516130</b>		
			4000K	<b>QBNE-3516140</b>		

RONDÒ

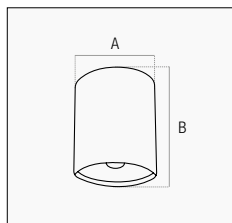

	A mm	B mm	g
10 W	∅ 90	90	322
15 W	∅ 110	123	551
25 W	∅ 130	155	838
35 W	∅ 170	185	1400

10 W	800 lm	Bianco / White ○	3000K	<b>RNDBI-109030</b>	6/24	€ 35,00
			4000K	<b>RNDBI-109040</b>		
		Nero / Black ●	3000K	<b>RNDNE-109030</b>		
			4000K	<b>RNDNE-109040</b>		
15 W	1.350 lm	Bianco / White ○	3000K	<b>RNDBI-1511030</b>	6/24	€ 58,00
			4000K	<b>RNDBI-1511040</b>		
		Nero / Black ●	3000K	<b>RNDNE-1511030</b>		
			4000K	<b>RNDNE-1511040</b>		
25 W	2.500 lm	Bianco / White ○	3000K	<b>RNDBI-2513030</b>	6/24	€ 79,00
			4000K	<b>RNDBI-2513040</b>		
		Nero / Black ●	3000K	<b>RNDNE-2513030</b>		
			4000K	<b>RNDNE-2513040</b>		
35 W	3.675 lm	Bianco / White ○	3000K	<b>RNDBI-3517030</b>	6/12	€ 103,00
			4000K	<b>RNDBI-3517040</b>		
		Nero / Black ●	3000K	<b>RNDNE-3517030</b>		
			4000K	<b>RNDNE-3517040</b>		

Plafoniera con corpo in alluminio, verniciato a polveri epossidiche antigraffio, dotata di parabola riflettente specchiata e vetro di protezione.

Ceiling lamp with aluminum body, painted with anti-scratch epoxy powders, equipped with mirrored reflector and protective glass.



QUBE



RONDO



STYLO



# QUBE - RONDÒ - STYLO

QUBE

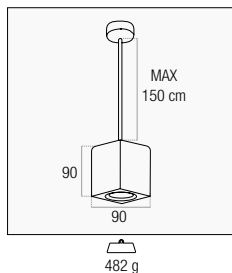

5 W	450 lm	45° ∠	Bianco / White ○	3000K	<b>QBBIP-059030</b>	6/24	€ 40,00
				4000K	<b>QBBIP-059040</b>		
			Nero / Black ●	3000K	<b>QBNEP-059030</b>		
				4000K	<b>QBNEP-059040</b>		

RONDÒ

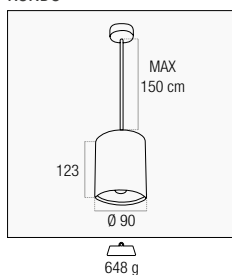

15 W	1.275 lm	45° ∠	Bianco / White ○	3000K	<b>RNDBIP-1511030</b>	6/24	€ 62,00
				4000K	<b>RNDBIP-1511040</b>		
			Nero / Black ●	3000K	<b>RNDNEP-1511030</b>		
				4000K	<b>RNDNEP-1511040</b>		

STYLO

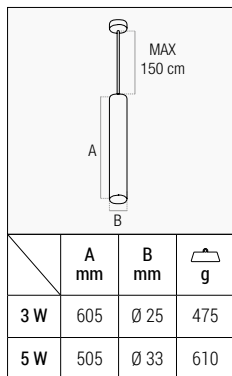

3 W	220 lm	60° ∠	Bianco / White ○	3000K	<b>STYLOBI600-032530</b>	6/24	€ 34,00
				4000K	<b>STYLOBI600-032540</b>		
			Nero / Black ●	3000K	<b>STYLONE600-032530</b>		
				4000K	<b>STYLONE600-032540</b>		
5 W	450 lm	60° ∠	Bianco / White ○	3000K	<b>STYLOBI500-053330</b>	6/24	€ 43,00
				4000K	<b>STYLOBI500-053340</b>		
			Nero / Black ●	3000K	<b>STYLONE500-053330</b>		
				4000K	<b>STYLONE500-053340</b>		

Sospensione LED con corpo in alluminio, verniciato a polveri epossidiche antigraffio, dotata di parabola riflettente specchiata e vetro di protezione.

Led suspension with aluminum body, painted with anti-scratch epoxy powders, equipped with mirrored reflector and protective glass.







DECORATIVO

# ENFASI STYLO

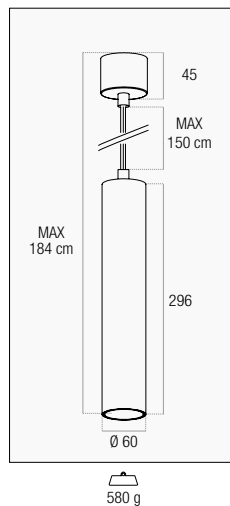

1 x GU10	Bianco / White ○	<b>ENSTYB-GU10</b>	6/24	€ 50,00
	Nero / Black ●	<b>ENSTYN-GU10</b>		

Sospensione regolabile fino a 180 cm  
Adjustable suspension up to 180 cm

Sospensione in alluminio per lampade spot GU10. E' possibile installare all'interno dell'apparecchio la lampada spot GU10 desiderata. Massima flessibilità ed efficacia. La lampada non è inclusa.

Aluminum suspension for GU10 spot lamps. It is possible to install the desired GU10 spot lamp inside the fixture. Maximum flexibility and effectiveness. The lamp is not included.



GU10

Non inclusa / Not included  
Vedi / Ref.



LEXAR - DICRO SHOP - SPOT MULTILED



# ENFASI SQUARE

1 SLOT

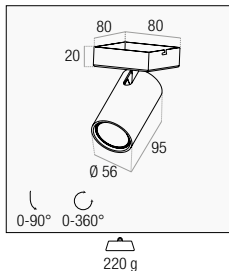

1 x GU10	Bianco / White ○	<b>ENSB-GU10</b>	6/24	€ 23,00
	Nero / Black ●	<b>ENSN-GU10</b>		

2 SLOT

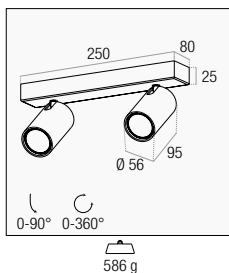

2 x GU10	Bianco / White ○	<b>ENSB-2GU10</b>	1/12	€ 37,00
	Nero / Black ●	<b>ENSN-2GU10</b>		

3 SLOT

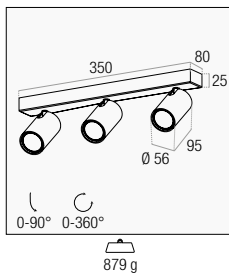

3 x GU10	Bianco / White ○	<b>ENSB-3GU10</b>	1/12	€ 60,00
	Nero / Black ●	<b>ENSN-3GU10</b>		

Portafaretti GU10 in alluminio con base rettangolare. E' possibile installare all'interno dell'apparecchio la lampada spot GU10 desiderata. Massima flessibilità ed efficacia. La lampada non è inclusa.

Aluminum GU10 spotlight holder with rectangular base. It is possible to install the desired GU10 spot lamp inside the fixture. Maximum flexibility and effectiveness. The lamp is not included.



GU10

Non inclusa / Not included  
Vedi / Ref.  
LEXAR - DICRO SHOP - SPOT MULTILED



ENRN

ENIBOR

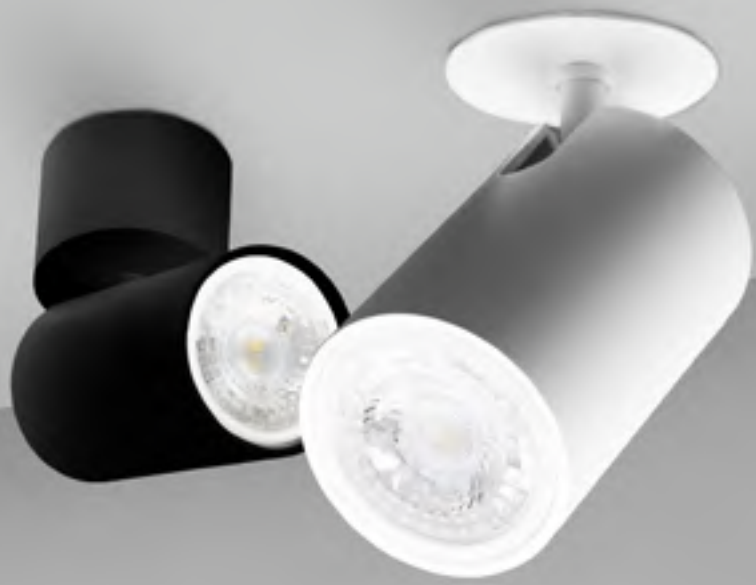

ENIB



# ENFASI ROUND

PLAFONE / CEILING

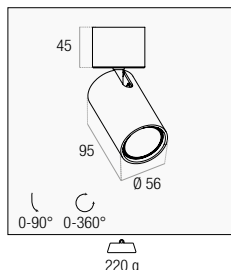

1 x GU10	Orientabile / Orientable	Bianco / White ○	<b>ENRB-GU10</b>	6/24	€ 26,00
		Nero / Black ●	<b>ENRN-GU10</b>		

INCASSO / RECESSED

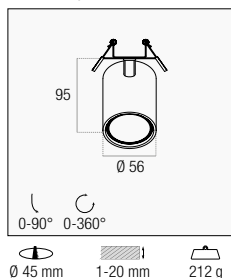

1 x GU10	Orientabile / Orientable	Bianco / White ○	<b>ENIBOR-GU10</b>	6/24	€ 26,00
		Nero / Black ●	<b>ENINOR-GU10</b>		

Attacco GU10 con box di collegamento professionale, montaggio rapido con clip  
 GU10 socket with professional connection box, quick assembly with clips



INCASSO / RECESSED

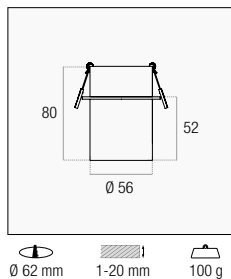

1 x GU10	Fisso / Fixed	Bianco / White ○	<b>ENIB-GU10</b>	6/24	€ 23,00
		Nero / Black ●	<b>ENIN-GU10</b>		

Montaggio rapido con clip  
 Quick assembly with clips

Portafaretti GU10 in alluminio con base rotonda. E' possibile installare all'interno dell'apparecchio la lampada spot GU10 desiderata. Massima flessibilità ed efficacia. La lampada non è inclusa.

Aluminum GU10 spotlight holder with round base. It is possible to install the desired GU10 spot lamp inside the fixture. Maximum flexibility and effectiveness. The lamp is not included.



GU10

Non inclusa / Not included  
 Vedi / Ref.



LEXAR - DICRO SHOP - SPOT MULTILED

ESQNG96-GU10



ESQNB160-2GU10

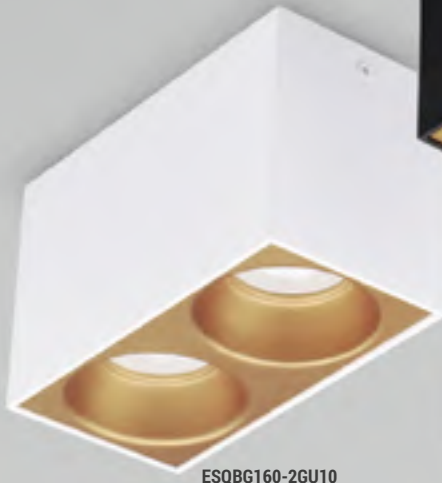

ESQBG160-2GU10

ESQBB80-GU10



DECORATIVO

# ESSENZA QUBE

QUBE

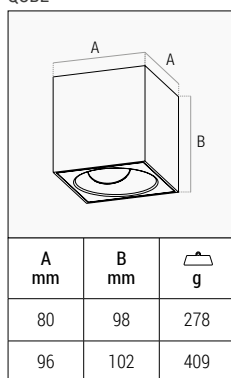

	A	OUT	IN			
1 x GU10	80 mm	Bianco / White ○	Oro / Gold ●	<b>ESQBG80-GU10</b>	1/24	€ 29,00
			Bianco / White ○	<b>ESQBB80-GU10</b>		
		Nero / Black ●	Oro / Gold ●	<b>ESQNG80-GU10</b>		
			Bianco / White ○	<b>ESQNB80-GU10</b>		
1 x GU10	96 mm	Bianco / White ○	Oro / Gold ●	<b>ESQBG96-GU10</b>	1/24	€ 35,00
			Bianco / White ○	<b>ESQBB96-GU10</b>		
		Nero / Black ●	Oro / Gold ●	<b>ESQNG96-GU10</b>		
			Bianco / White ○	<b>ESQNB96-GU10</b>		

QUBE DOPPIO

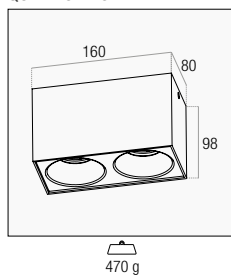

		OUT	IN			
2 x GU10		Bianco / White ○	Oro / Gold ●	<b>ESQBG160-2GU10</b>	1/12	€ 50,00
			Bianco / White ○	<b>ESQBB160-2GU10</b>		
		Nero / Black ●	Oro / Gold ●	<b>ESQNG160-2GU10</b>		
			Bianco / White ○	<b>ESQNB160-2GU10</b>		

Applique a soffitto in alluminio per lampade spot GU10. Diverse combinazioni di colore per adattarsi a tutti gli stili e tendenze.

Aluminum ceiling lamp for GU10 spot lamps. Different color combinations to suit all styles and trends.



Non inclusa / Not included  
Vedi / Ref.

LEXAR - DICRO SHOP - SPOT MULTILED



DECORATIVO

# ESSENZA RONDÒ

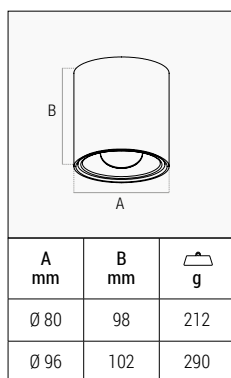

		A	OUT	IN		
1 x GU10	Ø 80 mm	Bianco / White ○	Oro / Gold ●	<b>ESRBG80-GU10</b>	1/24	€ 29,00
			Bianco / White ○	<b>ESRBB80-GU10</b>		
		Nero / Black ●	Oro / Gold ●	<b>ESRNG80-GU10</b>		
			Bianco / White ○	<b>ESRNB80-GU10</b>		
1 x GU10	Ø 96 mm	Bianco / White ○	Oro / Gold ●	<b>ESRBG96-GU10</b>	1/24	€ 32,00
			Bianco / White ○	<b>ESRBB96-GU10</b>		
		Nero / Black ●	Oro / Gold ●	<b>ESRNG96-GU10</b>		
			Bianco / White ○	<b>ESRNB96-GU10</b>		

Applique a soffitto in alluminio per lampade spot GU10. Diverse combinazioni di colore per adattarsi a tutti gli stili e tendenze.

Aluminum ceiling lamp for GU10 spot lamps. Different color combinations to suit all styles and trends.



Non inclusa / Not included  
Vedi / Ref.

LEXAR - DICRO SHOP - SPOT MULTILED





# ESSENZA ORIENTABILE



QUBE

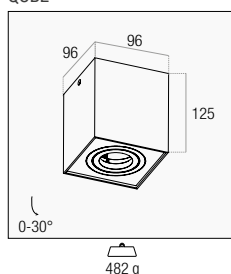

1 x GU10	Bianco / White ○	<b>ESQBOR96-GU10</b>	1/24	€ 35,00
	Nero / Black ●	<b>ESQNOR96-GU10</b>		

ROUND

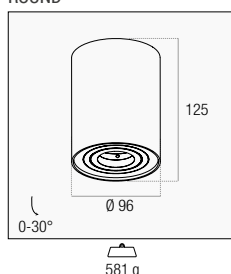

1 x GU10	Bianco / White ○	<b>ESRBOR96-GU10</b>	1/24	€ 32,00
	Nero / Black ●	<b>ESRNOR96-GU10</b>		

Applique a soffitto orientabile per lampade spot GU10. Massima flessibilità ed efficacia per adattarsi a tutti gli stili e tendenze.

Adjustable ceiling wall light for GU10 spot lamps. Maximum flexibility and effectiveness to adapt to all styles and trends.



Non inclusa / Not included  
Vedi / Ref.

LEXAR - DICRO SHOP - SPOT MULTILED

# FANTASY

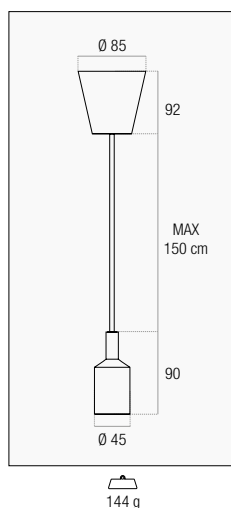

1 x E27	Visual Box	Bianco / White ○	<b>FTBI-150</b>	10/50	€ 7,00
		Grigio / Grey ●	<b>FTGR-150</b>		
		Nero / Black ●	<b>FTNE-150</b>		

Portalamпада in silicone con possibilità di svariate combinazioni di montaggio. Cavo lungo 150 cm.

Silicone lampholder with different mounting combinations. 150 cm long cable.



E27

Non inclusa / Not included  
Vedi / Ref.

INCANTO FILAMENTO MAX 60 W

# FUSION 150

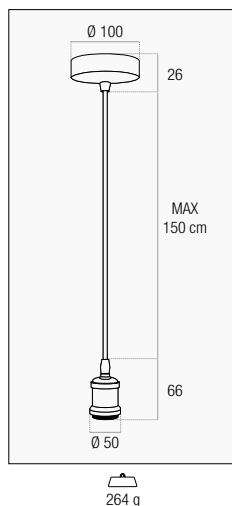

1 x E27	Blister	Bronzo / Bronze ●	<b>FSBR-150</b>	6/24	€ 18,00
		Nero Perla / Pearl Black ●	<b>FSNE-150</b>		
		Oro Rosa / Pink Gold ●	<b>FSRG-150</b>		
		Oro Rosa Anticato / Antique Pink Gold ●	<b>FSRGV-150</b>		



Blister



E27

Non inclusa / Not included  
Vedi / Ref.

INCANTO FILAMENTO EPOCA

Portalampada in alluminio pressofuso con possibilità di svariate combinazioni di montaggio. Cavo lungo 150 cm.

Die-cast aluminum lampholder with different mounting combinations. 150 cm long cable.







# COLORFULL

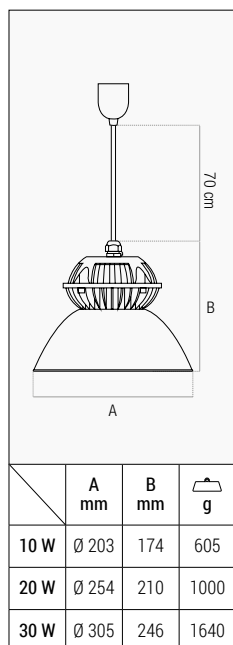

10 W	850 lm	60° ∠	Arancione / Orange ● 3000K	<b>CFAR-102030</b>	1/8	€ 43,00
			Bianco / White ○ 3000K	<b>CFBI-102030</b>		
			Rosso / Red ● 3000K	<b>CFRO-102030</b>		
			Verde / Green ● 3000K	<b>CFVE-102030</b>		
20 W	1.600 lm	60° ∠	Arancione / Orange ● 3000K	<b>CFAR-202530</b>	1/8	€ 55,00
			Bianco / White ○ 3000K	<b>CFBI-202530</b>		
			Rosso / Red ● 3000K	<b>CFAR-202530</b>		
			Verde / Green ● 3000K	<b>CFVE-202530</b>		
30 W	2.500 lm	60° ∠	Arancione / Orange ● 3000K	<b>CFAR-303030</b>	1/4	€ 70,00
			Rosso / Red ● 3000K	<b>CFAR-303030</b>		
			Verde / Green ● 3000K	<b>CFVE-303030</b>		

DECORATIVO

Corpo in alluminio verniciato e parabola in materiale plastico semitrasparente lucido. Completa di bicchiere di fissaggio più cavo di 70 cm.

Painted aluminum and body glossy reflector semi-transparent plastic material. Fixing cup and 70 cm cable included.



Completo di sistema per fissaggio a soffitto  
Ceiling fixing system included



DECORATIVO  
DECORATIVO  
**DECORATIVO**  
DECORATIVO  
DECORATIVO

GESSO  
GESSO  
**GESSO**  
GESSO  
GESSO

PLASTER  
PLASTER  
**PLASTER**  
PLASTER  
PLASTER

## Come installare i nostri prodotti in gesso da incasso. How to install our recessed plaster products.

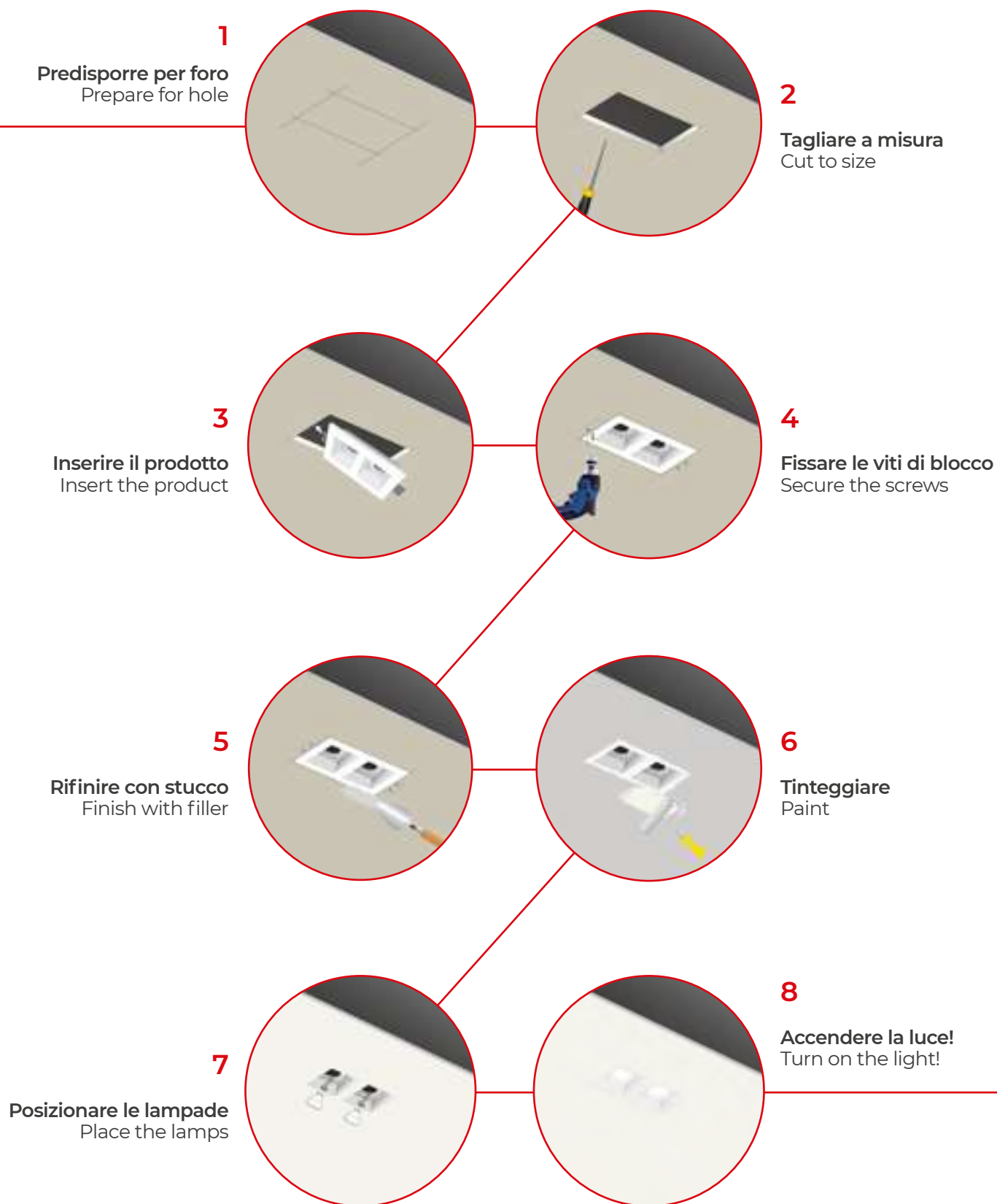



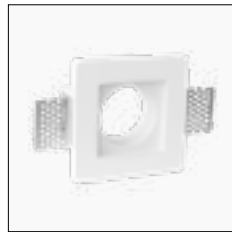
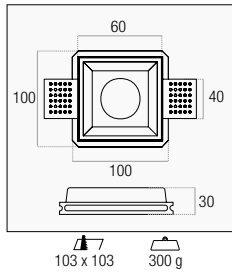

1 x GU10	Bianco / White ○	<b>JESSY-SQ100</b>	1/24	€ 9,00
----------	------------------	--------------------	------	--------

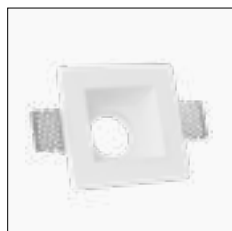
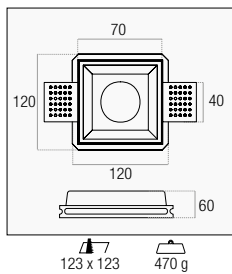

1 x GU10	Bianco / White ○	<b>JESSY-SQ120</b>	1/24	€ 13,00
----------	------------------	--------------------	------	---------

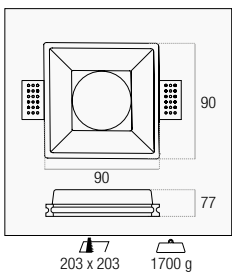

1 x AR111	Bianco / White ○	<b>JESSY-AR111</b>	1/6	€ 37,00
-----------	------------------	--------------------	-----	---------

DECORATIVO



Portalampana GU10 incluso  
GU10 Lamp holder included



GU10 AR111  
Non inclusa / Not included  
Vedi / Ref.  
LEXAR 6W / 8W - SUPERLED



Portafaretti da incasso in gesso adatti ad essere installati in ogni controsoffitto in maniera totalmente invisibile.

Plaster recessed spotlight holder suitable to be installed in any false ceiling in a totally invisible way.





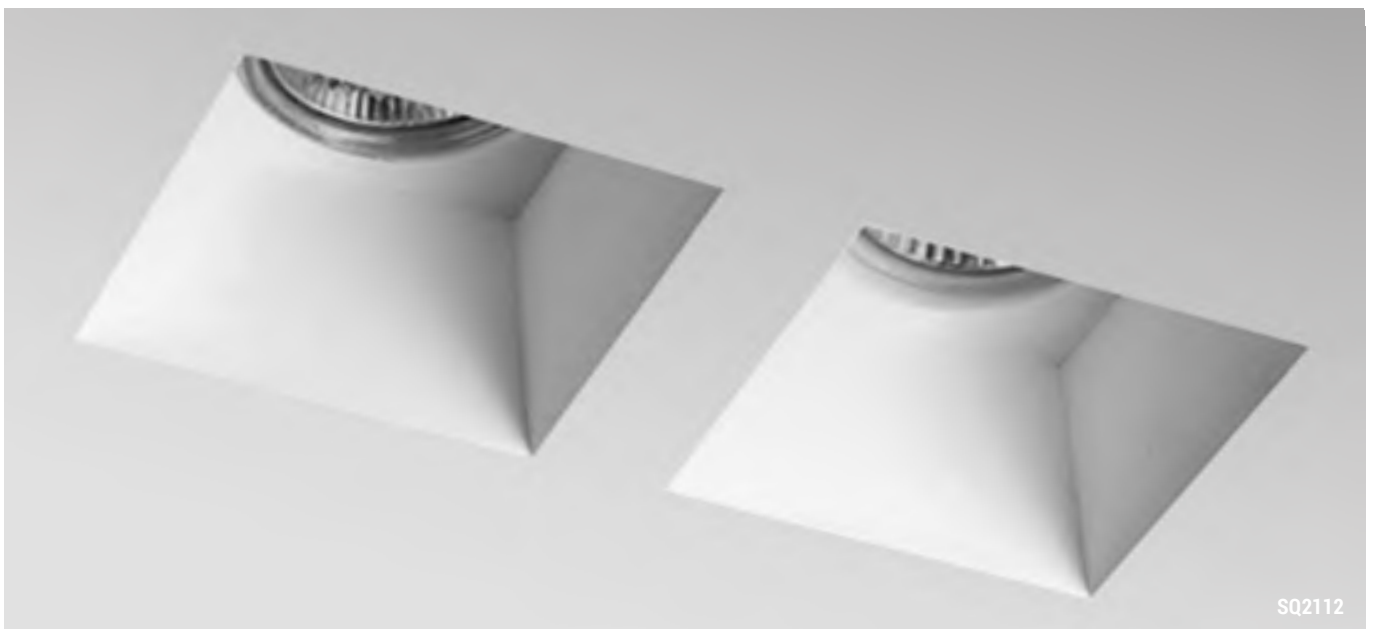
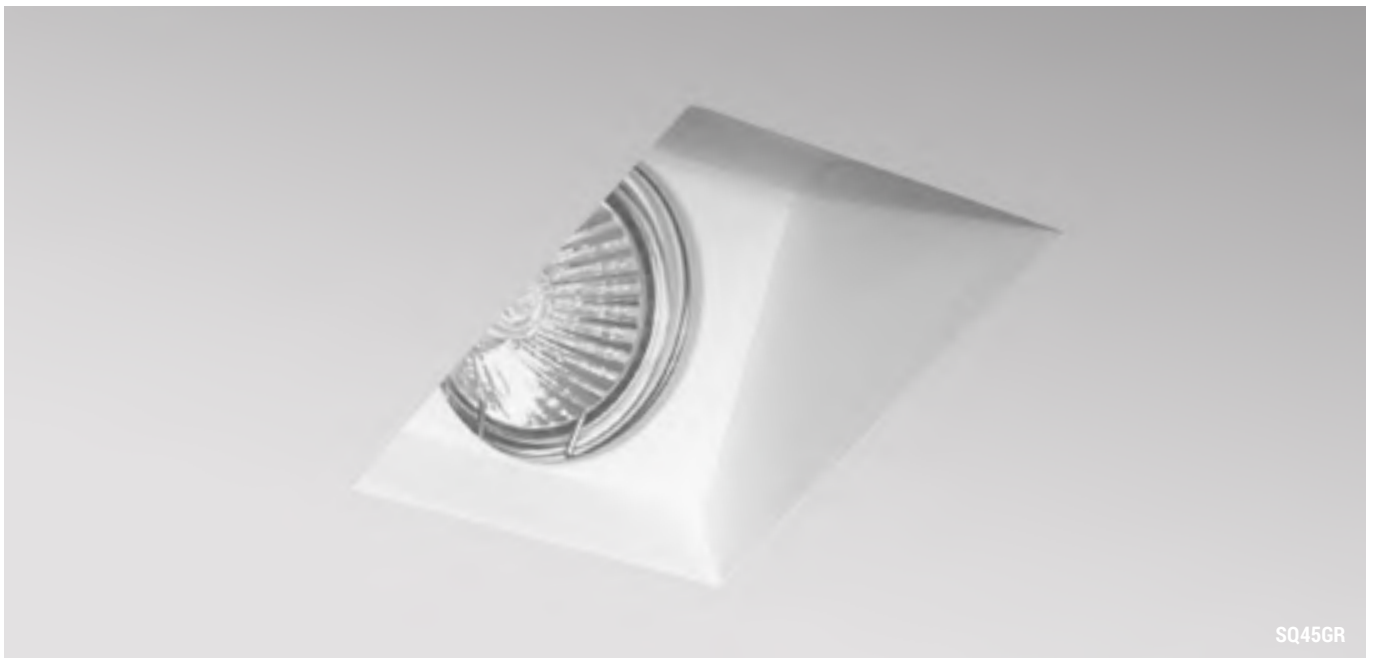
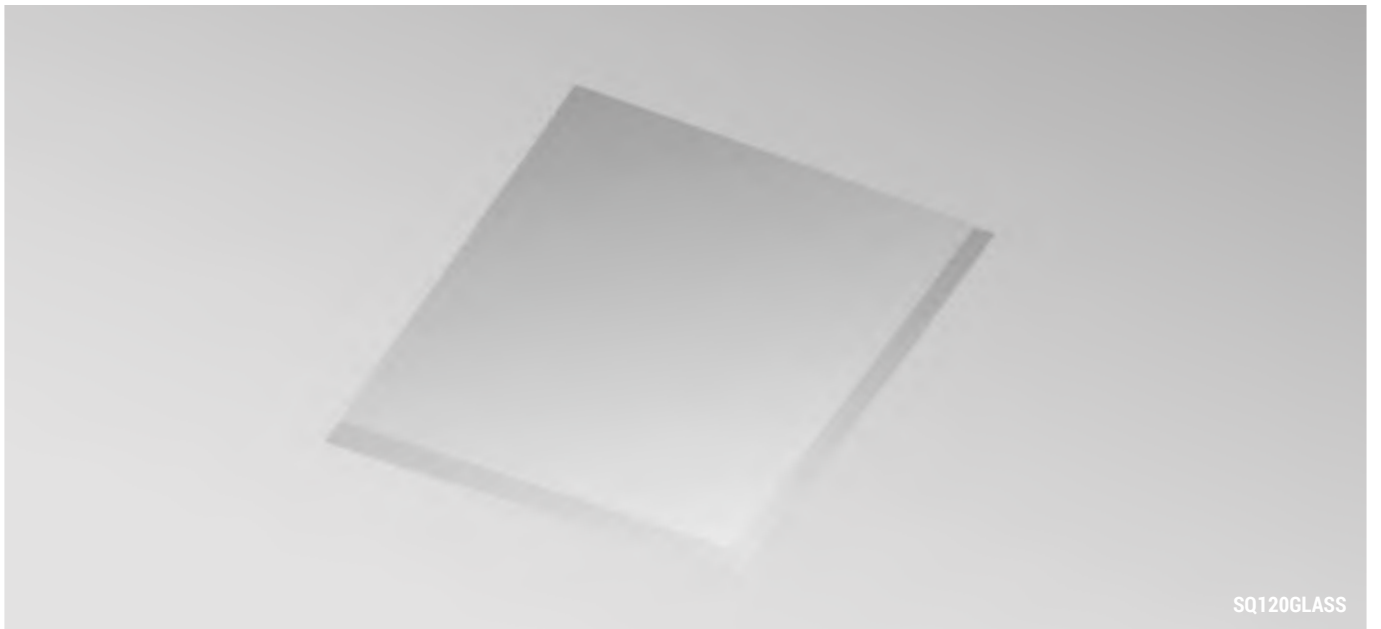

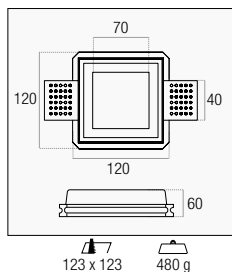

1 x GU10	Bianco / White ○	<b>JESSY-SQ120GLASS</b>	1/24	€ 13,00
----------	------------------	-------------------------	------	---------

Diffusore in vetro opale  
Opal glass diffuser

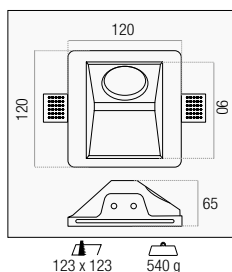

1 x GU10	Bianco / White ○	<b>JESSY-SQ45GR</b>	1/24	€ 13,00
----------	------------------	---------------------	------	---------

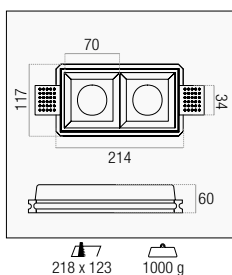

2 x GU10	Bianco / White ○	<b>JESSY2-SQ2112</b>	1/12	€ 24,00
----------	------------------	----------------------	------	---------



Portalamпада incluso  
Lamp holder included

Portafaretti da incasso in gesso adatti ad essere installati in ogni controsoffitto in maniera totalmente invisibile.

Plaster recessed spotlight holder suitable to be installed in any false ceiling in a totally invisible way.



GU10

Non inclusa / Not included  
Vedi / Ref.

LEXAR 6W / 8W





SR120



RD100



RD130

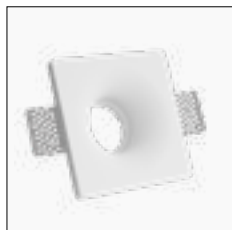
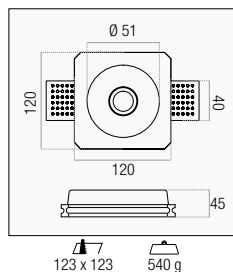

1 x GU10	Bianco / White ○	<b>JESSY-SR120</b>	1/24	€ 13,00
----------	------------------	--------------------	------	---------

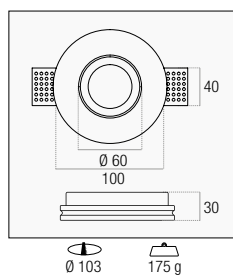

1 x GU10	Bianco / White ○	<b>JESSY-RD100</b>	1/24	€ 9,00
----------	------------------	--------------------	------	--------

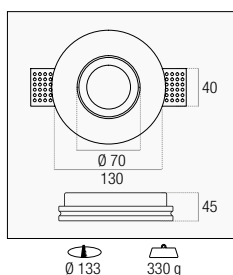

1 x GU10	Bianco / White ○	<b>JESSY2-RD130</b>	1/24	€ 13,00
----------	------------------	---------------------	------	---------

DECORATIVO



Portalamпада incluso  
Lamp holder included

Portafaretti da incasso in gesso adatti ad essere installati in ogni controsoffitto in maniera totalmente invisibile.

Plaster recessed spotlight holder suitable to be installed in any false ceiling in a totally invisible way.



GU10

Non inclusa / Not included  
Vedi / Ref.

LEXAR 6W / 8W

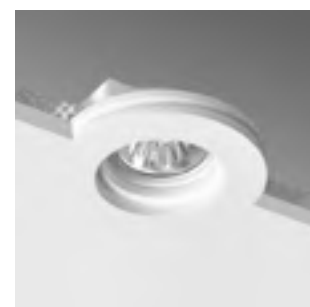

CESSO

# KON170

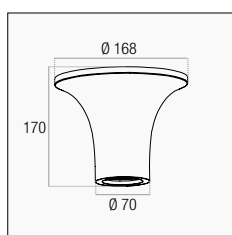

1000 g

1 x GU10	Bianco / White ○	<b>KON170</b>	1/8	€ 45,00
----------	------------------	---------------	-----	---------

Supporto in gesso resinato adatto a essere installato a soffitto. Può essere verniciato per ottenere un effetto a scomparsa.

Ceiling-mounted resin-coated plaster support, suitable for painted for achieving an hidden effect.



GU10

Non inclusa / Not included  
Vedi / Ref.

LEXAR 6W / 8W



# ECLISSE

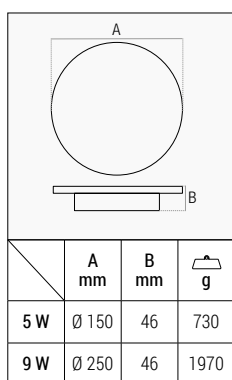

5 W	= 25 W	280 lm	Bianco / White		3000K		<b>ECLISSE150</b>	1/16	€ 98,00
9 W	= 30 W	320 lm	Bianco / White		3000K		<b>ECLISSE250</b>	1/8	€ 173,00

DECORATIVO

Applique in gesso resinato adatta a essere installata a parete.  
Luce decorativa dal design moderno.

Resin-coated plaster applique suitable for wall.  
Decorative light with a modern design.



Luce soffusa per un ambiente confortevole  
Soft light for a comfortable ambience



BOLLE



MIRO200



DALI310

# JESSY BOLLE MIRO200 - DALI310

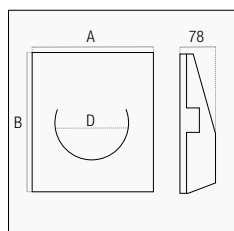

1 x GU10	Bianco / White ○	<b>JESSY-BOLLE150</b>	1/4	€ 62,00
		<b>JESSY-BOLLE250</b>	1/3	€ 79,00

	A mm	B mm	D mm	h mm	g
150	210	250	Ø 14	213x253	2500
250	290	350	Ø 24	293x353	4480

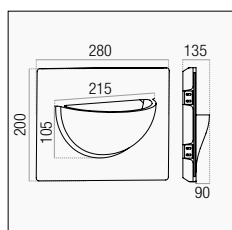

1 x E14	Bianco / White ○	<b>MIRO200</b>	1/6	€ 67,00
---------	------------------	----------------	-----	---------

285 x 205 3600 g

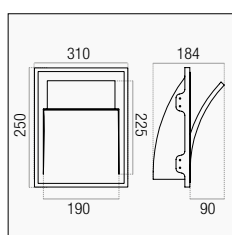

1 x E14	Bianco / White ○	<b>DALI310</b>	1/4	€ 115,00
---------	------------------	----------------	-----	----------

323 x 263 3810 g

Supporti in gesso da incasso a parete. Possono essere verniciati per ottenere un effetto a scomparsa.

Plaster supports for wall suitable to be painted for achieving an hidden effect.



Non inclusa / Not included  
Vedi / Ref.

LEXAR - INCANTO FILAMENTO



180



230



320

# SOFFIO

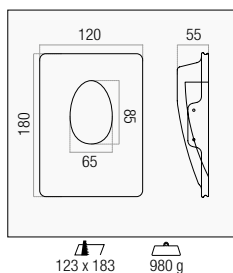

1 W	70 lm	Bianco / White	○	3000K	<b>SOFFIO180</b>	1/24	€ 74,00
-----	-------	----------------	---	-------	------------------	------	---------

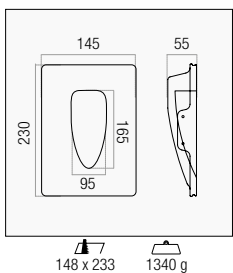

1 W	70 lm	Bianco / White	○	3000K	<b>SOFFIO230</b>	1/12	€ 77,00
-----	-------	----------------	---	-------	------------------	------	---------

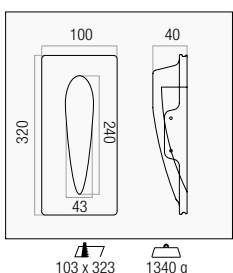

1 W	70 lm	Bianco / White	○	3000K	<b>SOFFIO320</b>	1/12	€ 77,00
-----	-------	----------------	---	-------	------------------	------	---------

DECORATIVO

Segnapasso in gesso a scomparsa totale, veloci da installare. Luce decorativa dal design semplice e moderno.

Total disappearing plaster steplight, quick to install. Decorative light with a simple and modern design.







AP115



AP125



AP275



AP360

**NEW**

APPLIQUE - GESSO

# JESSY

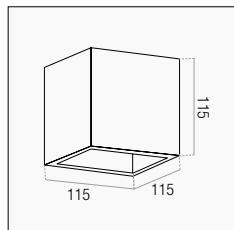

1128 g

1x G9	Bianco / White ○	<b>JESSY-AP115 NEW</b>	1/18	€ 33,00
-------	------------------	------------------------	------	---------

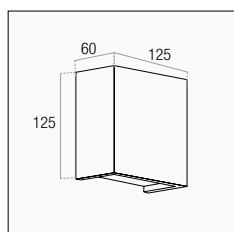

797 g

1x G9	Bianco / White ○	<b>JESSY-AP125 NEW</b>	1/12	€ 33,00
-------	------------------	------------------------	------	---------

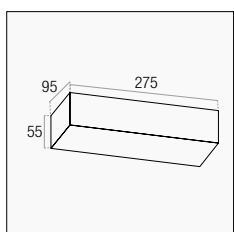

1136 g

1x E14	Bianco / White ○	<b>JESSY-AP275 NEW</b>	1/12	€ 38,00
--------	------------------	------------------------	------	---------

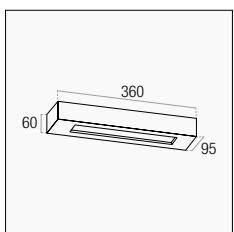

1613 g

2x E14	Bianco / White ○	<b>JESSY-AP360 NEW</b>	1/12	€ 50,00
--------	------------------	------------------------	------	---------

Eleganti applique in gesso per una luce diffusa sulla parete. Possono essere dipinte per integrarsi in ogni ambiente.

Elegant plaster wall light for a diffused light effect. Suitable to be painted for every ambients customization.

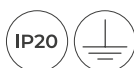

Non inclusa / Not included  
Vedi / Ref.

PIXYFULL - INCANTO FILAMENTO



AP150



AP180

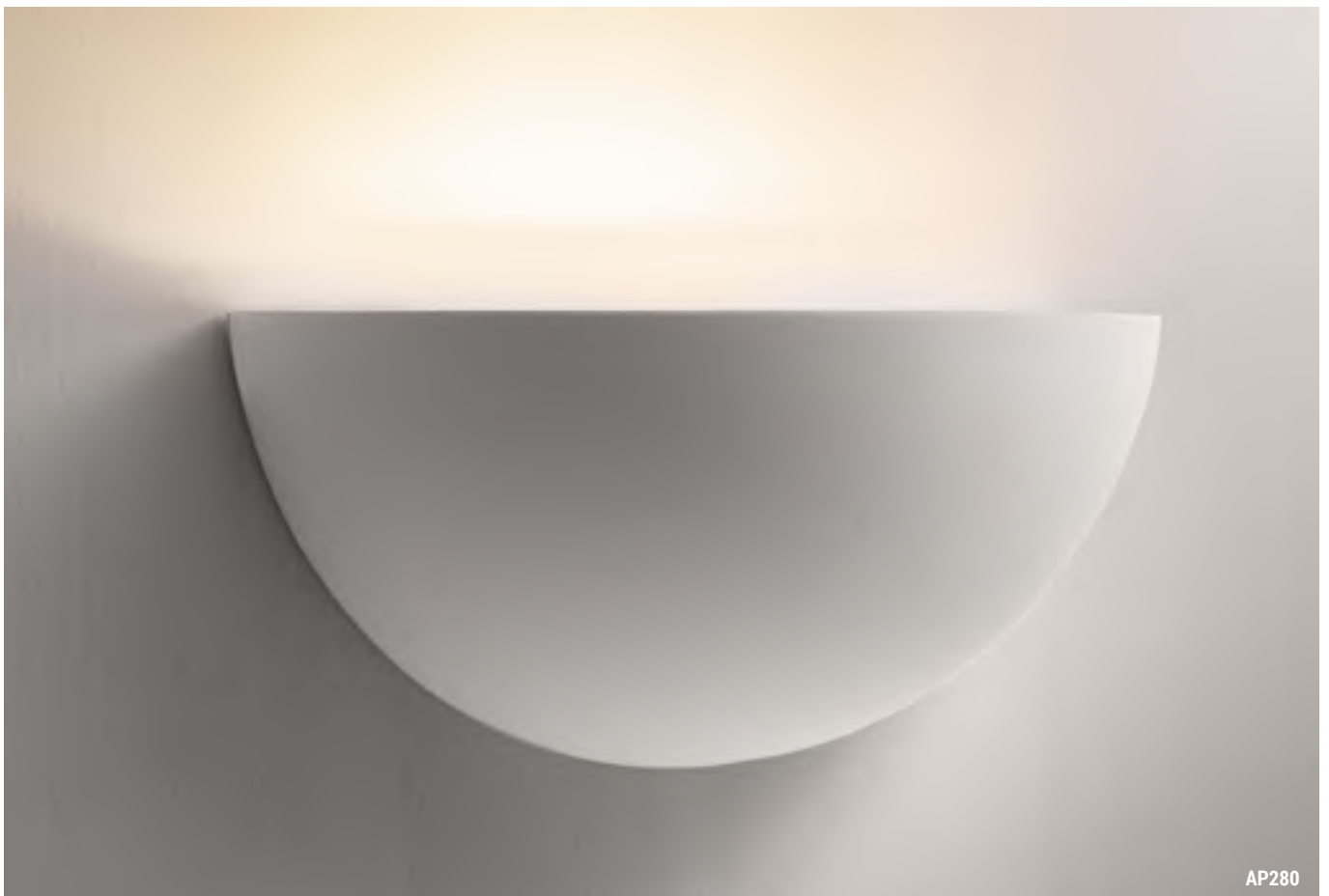

AP280

**NEW**

APPLIQUE - GESSO

# JESSY

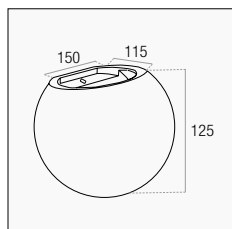

962 g

1x G9	Bianco / White ○	<b>JESSY-AP150 NEW</b>	1/12	€ 35,00
-------	------------------	------------------------	------	---------

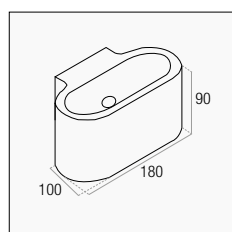

797 g

1x G9	Bianco / White ○	<b>JESSY-AP180 NEW</b>	1/9	€ 36,00
-------	------------------	------------------------	-----	---------

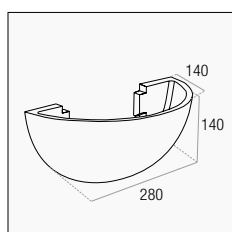

1595 g

1x E14	Bianco / White ○	<b>JESSY-AP280 NEW</b>	1/6	€ 38,00
--------	------------------	------------------------	-----	---------

Eleganti applique in gesso per una luce diffusa sulla parete. Possono essere dipinte per integrarsi in ogni ambiente.

Elegant plaster wall light for a diffused light effect. Suitable to be painted for every ambients customization.



Non inclusa / Not included  
Vedi / Ref.

PIXYFULL - INCANTO FILAMENTO

EMERGENZA  
EMERGENZA  
**EMERGENZA**  
EMERGENZA  
EMERGENZA

EMERGENCY  
EMERGENCY  
**EMERGENCY**  
EMERGENCY  
EMERGENCY

EMERGENZA

# SICURA LED

EMERG.  
3h

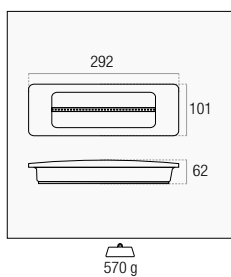

4 W	210 lm	3h Emerg.	4000K	<b>SCL-020340</b>	1/12	€ 38,00
-----	--------	-----------	-------	-------------------	------	---------

2 modalità / 2 modes



SA  
Sempre Accesa  
Always on

SE  
Solo Emergenza  
Only Emergency

Si accende in mancanza di energia elettrica rimanendo attiva per 3 ore. Installabile a superficie o a incasso con apposito box incluso.

In case of lack of electricity the lamp turns on for 3 hours. Surface or recessed installation with special box included.



Box da incasso incluso  
Recessed box included



## EMERGENZA / EMERGENCY

### PRATIKA

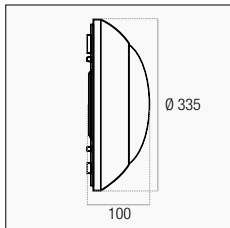

PLAFONIERE - PAG. 89

1300 g

	SOURCE		OUTPUT			
18 W	1.450 lm	1.200 lm	3h Emerg.	4000K	<b>PRKE-183240</b>	1/6



Ricambio driver emergenza opzionale  
Optional emergency driver spare

**RDPRKE NEW**

### ITALIA ROUND

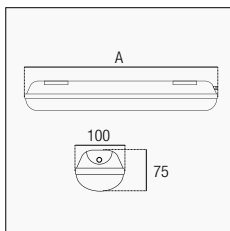

PLAFONIERE STAGNE - PAG. 145

A		SOURCE		OUTPUT			
120 cm	1400 g	40 W	5.300 lm	4.200 lm	3h Emerg.	4000K	<b>ITLRE-401240</b>
150 cm	2100 g	40 W	4.790 lm	4.200 lm	3h Emerg.	4000K	<b>ITLRE-401540</b>
		60 W	6.840 lm	6.000 lm	3h Emerg.	4000K	<b>ITLRE-601540</b>



1/6

### CORTÈS

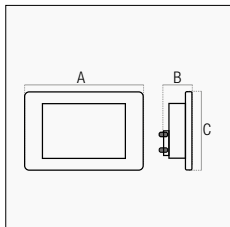

OUTDOOR - PAG. 218

					A	B	C					
1 W	70 lm	3h Emerg.	IP20	107	45	68	126	Cover	+	4000K	<b>CRT3E-010340</b>	1/40
5 W	280 lm	3h Emerg.	IP65	180	49	80	198	Cover	+	4000K	<b>CRT6E-050340</b>	1/50



Cover in metallo satinato intercambiabile inclusa  
Interchangeable satin metal cover included

## EMERGENZA / EMERGENCY

### COMODA

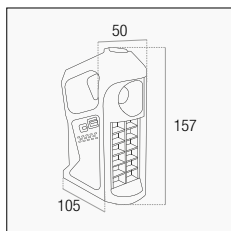

6 W	Li-Ion 3,7 V/DC 1.500 mAh*	6500K	<b>CMDEM-060065</b>	10/50
-----	----------------------------	-------	---------------------	-------

Ricarica ~3 h / Autonomia fino a ~4-6 h  
Recharge ~3 h / Autonomy up to ~4-6 h



Powerbank



Ricaricabile  
Rechargeable

\*1 anno di garanzia / 1 year warranty

VERSATILI - PAG. 374

166 g

### Doppia modalità luminosa / Double light mode

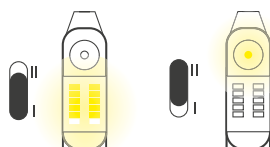

### Modalità emergenza / Emergency mode



Con interruttore impostato su I, mentre è in carica, la torcia resta spenta per poi accendersi in caso di blackout.

With the switch set to I, while it is charging, the flashlight remains off and then turns on in case of a blackout.

### KIT EMERGENZA 2 H

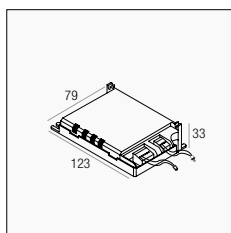

EMERG.	INPUT	OUTPUT		RICARICA / RECHARGE	
2 h MAX 3 W	110-240 V/AC 50/60 Hz	12-80 V/DC 50 mA	Ni-CD 7.2 V/DC 1.000 mAh	24 h	<b>KIT-EMG2</b> 1/48



Utilizzabile su qualsiasi apparecchio con **driver** separato.  
Compreso di **indicatore LED** e **Test Switch**.

Can be used on any device with separate **driver**.  
**LED indicator** and **Test Switch** included.

PANNELLI - PAG. 56

233 g

#### Compatibile con / Compatible with:

FUTURA ADVANCE FTA da 8W a 32W  
FUTURA PRO FTP 10W / 15W / 20W / 28W / 35W  
ZENO ZNS 10W / 16W / 32W - ZNR 10W / 16W / 32W  
P-QUADRO / P-TONDO PT e PQ da 12 a 24W / PQP e PTP 18W e 24W  
(compatibilità elettronica e non meccanica)  
P-LINE 40 PL 40W  
P-QUADRO 42U  
P-QUADRO ADVANCE PQA 24W / 42W / 80W - KIT-PQA 40W - PQAN 40W - PQAM

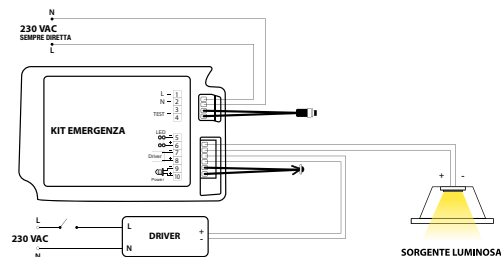

### KIT EMERGENZA 3 H

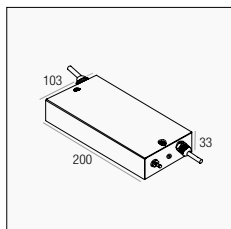

EMERG.	INPUT	OUTPUT		RICARICA / RECHARGE	
3 h 3-5 W	110-265 V/AC 50/60 Hz	12-60 V/DC 100 mA	Ni-CD 6 V/DC 3.000 mAh	24 h	<b>KIT-EMG</b> 1/18



Utilizzabile su qualsiasi apparecchio con **driver** separato.  
Compreso di **indicatore LED** e **Test Switch**.

Can be used on any device with separate **driver**.  
**LED indicator** and **Test Switch** included.

PANNELLI - PAG. 56

765 g

#### Compatibile con / Compatible with:

FUTURA ADVANCE FTA da 8W a 32W  
FUTURA SHOP 95 FTS da 30W/60W  
P-QUADRO 42U  
P-QUADRO ADVANCE PQA 24W / 42W / 80W - KIT-PQA 40W - PQAN 40W - PQAM  
P-LINE 40 PL 40W

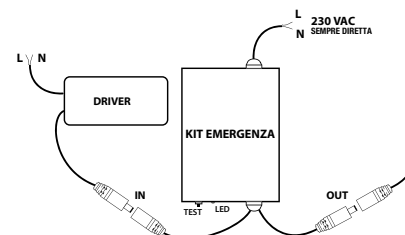



DECORATIVO  
DECORATIVO  
**DECORATIVO**  
DECORATIVO  
DECORATIVO

TRACK LIGHT  
**TRACK LIGHT**  
TRACK LIGHT  
TRACK LIGHT





**TRACK LIGHT**

# BINARY

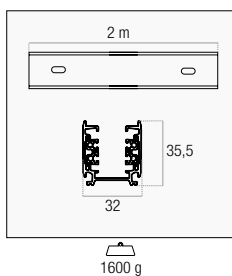

Bianco / White ○	<b>BNRBI-2000</b>	1/10	€ 53,00
Nero / Black ●	<b>BNRNE-2000</b>		

Trifase / Three-Phase

DECORATIVO

Binario per l'installazione di faretti o sospensioni LED nella posizione desiderata. Il sistema trifase permette fino a tre accensioni indipendenti. Può essere installato sia a parete che a soffitto e, in alternativa, anche a sospensione tramite KIT opzionale. Il sistema binario è completamente personalizzabile grazie agli accessori.

Track suitable for LED spotlights or suspensions installation. The three-phase system allows up to three independent ignitions. To be installed both on the wall and on the ceiling or suspended by an optional KIT. The track system is completely customizable thanks to the accessories.





**NEW**

ACCESSORI - TRACK LIGHT

# CONNETTORI CONNECTORS

ADATTATORE PER SOSPENSIONE / SUSPENSION ADAPTER

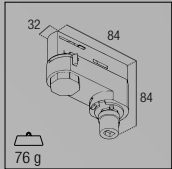

Bianco / White ○	<b>ACBNRBI-AD NEW</b>	1/50	€ 11,00
Nero / Black ●	<b>ACBNRNE-AD NEW</b>		

Adattatore per binario trifase per l'installazione di lampade a sospensione. **Portata max 5 kg**

Three-phase track adapter for pendant lamps installation. **Max load 5 kg.**

## Sistema a binario lineare / Linear track system

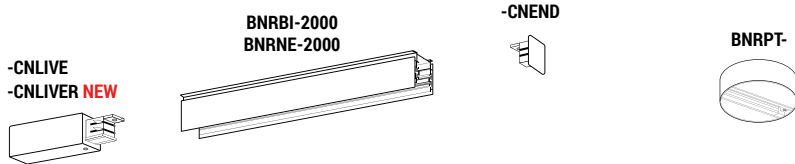

## Sistema a binario personalizzato / Custom track system

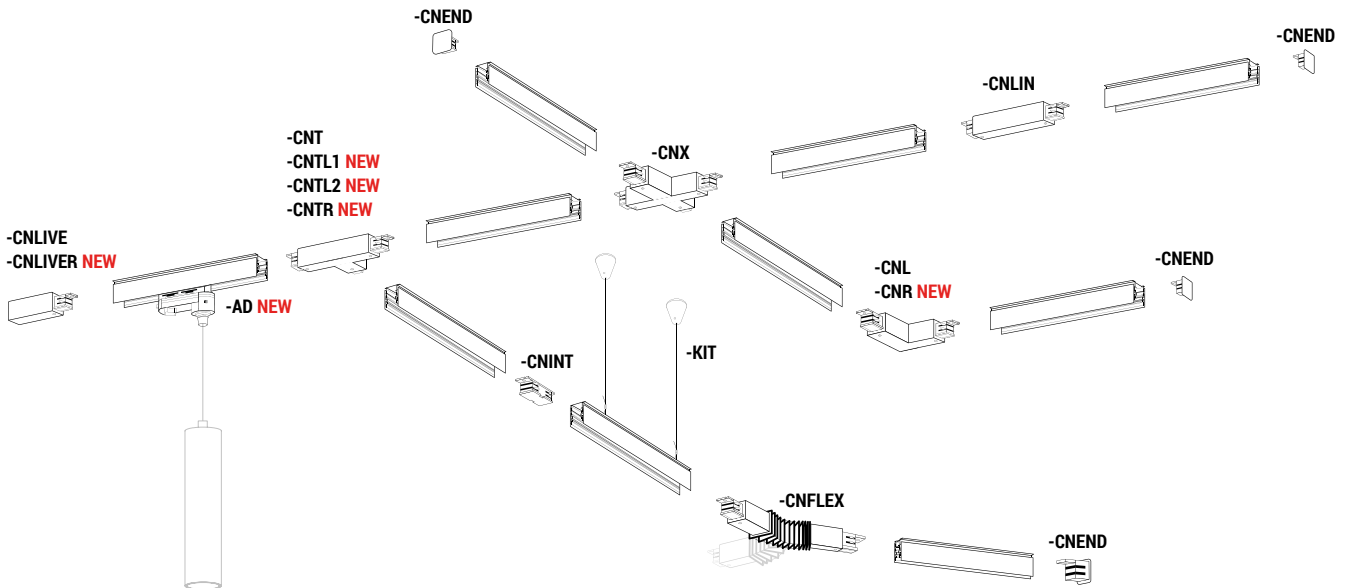

220-240  
V/AC    MAX  
10 A

ALIMENTAZIONE / SUPPLY

POWER ⚡

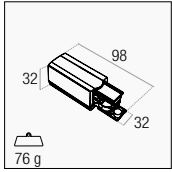

Sinistro - Left	Bianco / White ○	<b>ACBNRBI-CNLIVE</b>	5/90	€ 7,00
	Nero / Black ●	<b>ACBNRNE-CNLIVE</b>		
Destro - Right	Bianco / White ○	<b>ACBNRBI-CNLIVER NEW</b>	1/50	€ 7,00
	Nero / Black ●	<b>ACBNRNE-CNLIVER NEW</b>		

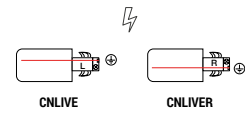

TERMINALE / END CAP

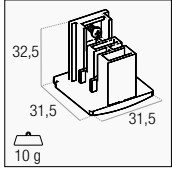

Bianco / White ○	<b>ACBNRBI-CNEND</b>	10/180	€ 1,20
Nero / Black ●	<b>ACBNRNE-CNEND</b>		

GIUNTO A L / L-JOINT

POWER ⚡

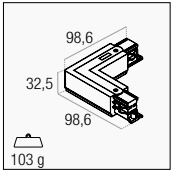

Sinistro - Left	Bianco / White ○	<b>ACBNRBI-CNL</b>	10/180	€ 14,00
	Nero / Black ●	<b>ACBNRNE-CNL</b>		
Destro - Right	Bianco / White ○	<b>ACBNRBI-CNR NEW</b>	1/25	€ 14,00
	Nero / Black ●	<b>ACBNRNE-CNR NEW</b>		

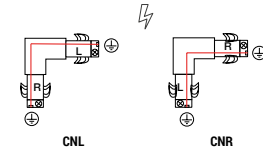

GIUNTO A T / T-JOINT

POWER ⚡

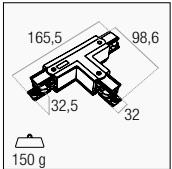

Destro - Sinistro / Right - Left	Bianco / White ○	<b>ACBNRBI-CNT</b>	10/180	€ 19,00
	Nero / Black ●	<b>ACBNRNE-CNT</b>		
Sinistro - Destro / Left - Right	Bianco / White ○	<b>ACBNRBI-CNTL1 NEW</b>	1/25	€ 20,00
	Nero / Black ●	<b>ACBNRNE-CNTL1 NEW</b>		
Sinistro - Sinistro / Left - Left	Bianco / White ○	<b>ACBNRBI-CNTL2 NEW</b>	1/25	€ 20,00
	Nero / Black ●	<b>ACBNRNE-CNTL2 NEW</b>		
Destro - Destro / Right - Right	Bianco / White ○	<b>ACBNRBI-CNTR NEW</b>	1/25	€ 20,00
	Nero / Black ●	<b>ACBNRNE-CNTR NEW</b>		

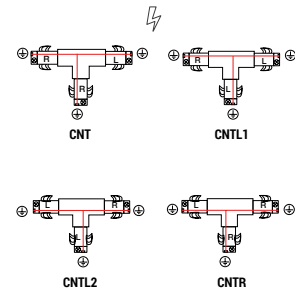

GIUNTO LINEARE / LINEAR JOINT

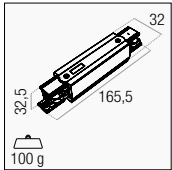

B/W ○	<b>ACBNRBI-CNLIN</b>	20/80	€ 14,00
N/B ●	<b>ACBNRNE-CNLIN</b>		



GIUNTO FLESSIBILE / FLEXIBLE JOINT

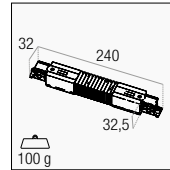

B/W ○	<b>ACBNRBI-CNFLEX</b>	10/40	€ 20,00
N/B ●	<b>ACBNRNE-CNFLEX</b>		



GIUNTO A X / X-JOINT

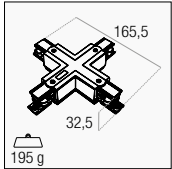

B/W ○	<b>ACBNRBI-CNX</b>	10/180	€ 24,00
N/B ●	<b>ACBNRNE-CNX</b>		

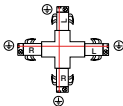

GIUNTO INTERNO (A SCOMPARSA) / INTERNAL HIDDEN JOINT

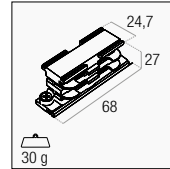

B/W ○	<b>ACBNRBI-CNINT</b>	10/180	€ 7,00
N/B ●	<b>ACBNRNE-CNINT</b>		

PLAFONIERA BINARIO / BINARY CEILING

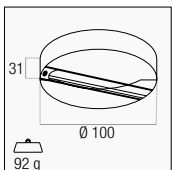

B/W ○	<b>BNRPT-BI</b>	1/10	€ 20,00
N/B ●	<b>BNRPT-NE</b>		

Trifase / Three-Phase

KIT SOSPENSIONE 2 m / SUSPENSION KIT 2 mt

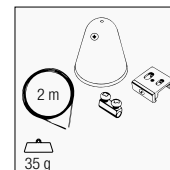

B/W ○	<b>ACBNRBI-KIT</b>	5/90	€ 6,50
N/B ●	<b>ACBNRNE-KIT</b>		

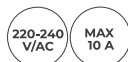

TRACK LIGHT

# REGIA SHOP GU10

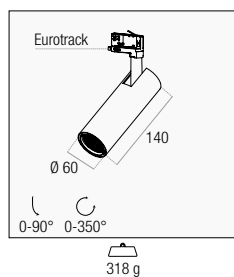

1 x GU10	Bianco / White ○	<b>RGTBI-GU10</b>	6/36	€ 37,00
	Nero / Black ●	<b>RGTNE-GU10</b>		

Track light GU10 per binario Eurotrack. E' possibile installare all'interno dell'apparecchio la lampada spot GU10 desiderata.

Eurotrack GU10 spotlight holder. Suitable for any GU10 lamp.



Non inclusa / Not included  
Vedi / Ref.



LEXAR - DICRO SHOP 95 - SPOT MULTILED

TRACK LIGHT

# REGIA SHOP 180

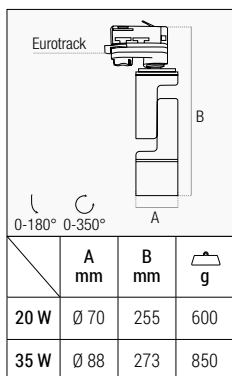

SOURCE		OUTPUT							
20 W	1.700 lm	1.600 lm	38° ∠	UGR<19 - CRI 90	Bianco / White ○	3000K	<b>RGT180BI-207030</b>	1/6	€ 58,00
						4000K	<b>RGT180BI-207040</b>		
					Nero / Black ●	3000K	<b>RGT180NE-207030</b>		
						4000K	<b>RGT180NE-207040</b>		
35 W	3.100 lm	2.800 lm	38° ∠	UGR<19 - CRI 90	Bianco / White ○	3000K	<b>RGT180BI-359030</b>	1/6	€ 79,00
						4000K	<b>RGT180BI-359040</b>		
					Nero / Black ●	3000K	<b>RGT180NE-359030</b>		
						4000K	<b>RGT180NE-359040</b>		

DECORATIVO

Apparecchio LED per binario Eurotrack ad alte prestazioni. Il corpo snodabile permette di direzionare la luce in maniera ottimale.

Eurotrack High performance LED luminaire. Jointed body for a focused and directional light.





ROUND



SQUARE

# REGIA SHOP

## Dimmerabile



### ROUND

	A mm	B mm	C mm	g
25 W	166	132	Ø 70	663
30 W	187	151	Ø 90	1050

### OUTPUT

15 W	1.380 lm	38° ∠	Dimm. - CRI 95	Bianco / White ○	4000K	<b>RGTD-157040</b>	1/6	€ 106,00
25 W	2.150 lm	38° ∠	Dimm. - CRI 95	Bianco / White ○	3000K	<b>RGTD-259030</b>	1/6	€ 156,00

### SQUARE

	A mm	B mm	C mm	g
12 W	139	166	Ø 81	508
25 W	173	213	Ø115	1035
36 W	173	215	Ø115	1035

### OUTPUT

12 W	1.032 lm	38° ∠	Dimm. - CRI 95	Bianco / White ○	3000K	<b>RGSD-128030</b>	1/6	€ 113,00
	1.044 lm	38° ∠	Dimm. - CRI 95	Bianco / White ○	4000K	<b>RGSD-128040</b>		
25 W	2.150 lm	38° ∠	Dimm. - CRI 95	Bianco / White ○	3000K	<b>RGSD-251130</b>	1/6	€ 146,00
	2.300 lm	38° ∠	Dimm. - CRI 95	Bianco / White ○	4000K	<b>RGSD-251140</b>		
36 W	3.020 lm	38° ∠	Dimm. - CRI 95	Bianco / White ○	3000K	<b>RGSD-361130</b>	1/6	€ 173,00
	3.200 lm	38° ∠	Dimm. - CRI 95	Bianco / White ○	4000K	<b>RGSD-361140</b>		

DECORATIVO

Apparecchio a binario professionale con attacco trifase Eurotrack. Dimmerabile con sistemi Trailing Edge.

Professional track luminaire with three-phase Eurotrack connection. Dimmable with Trailing Edge systems.



Dimmerabili con sistemi Trailing-Edge  
Dimmable with Trailing-Edge systems



# REGIA SHOP LINEARE

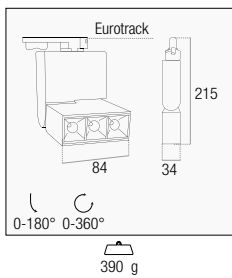

OUTPUT								
9 W	500 lm	30° ∠	UGR<19 - CRI 90	Bianco / White ○	3000K	<b>RGLBI-098330</b>	1/6	€ 65,00
					4000K	<b>RGLBI-098340</b>		
				Nero / Black ●	3000K	<b>RGLNE-098330</b>		
					4000K	<b>RGLNE-098340</b>		

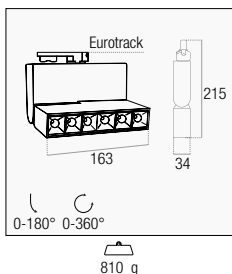

OUTPUT								
18 W	1.200 lm	30° ∠	UGR<19 - CRI 90	Bianco / White ○	3000K	<b>RGLBI-1816330</b>	1/6	€ 101,00
					4000K	<b>RGLBI-1816340</b>		
				Nero / Black ●	3000K	<b>RGLNE-1816330</b>		
					4000K	<b>RGLNE-1816340</b>		

Apparecchio LED per binario Eurotrack ad alte prestazioni. Il corpo snodabile permette di direzionare la luce in maniera ottimale.

Eurotrack High performance LED luminaire. Jointed body for a focused and directional light.



# REGIA BINARIO



25 W



30 W

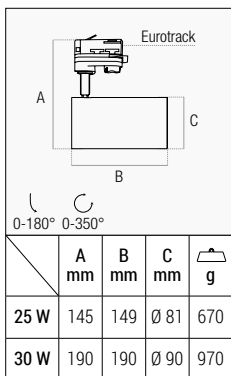

		SOURCE		OUTPUT					
25 W	2.540 lm	2.376 lm	36° ∠	CRI 95	Bianco / White ○	3000K	<b>RGTBI-258030</b>	1/6	€ 86,00
						4000K	<b>RGTBI-258040</b>		
					Nero / Black ●	3000K	<b>RGTNE-258030</b>		
						4000K	<b>RGTNE-258040</b>		
30 W	-	2.550 lm	36° ∠	Dimm. - CRI 95	Bianco / White ○	3000K	<b>RGTBID-309030</b>	1/6	€ 130,00
	-	2.700 lm	36° ∠	Dimm. - CRI 95	Bianco / White ○	4000K	<b>RGTBID-309040</b>		
	-	2.550 lm	36° ∠	Dimm. - CRI 95	Nero / Black ●	3000K	<b>RGTNED-309030</b>		
	-	2.700 lm	36° ∠	Dimm. - CRI 95	Nero / Black ●	4000K	<b>RGTNED-309040</b>		

DECORATIVO

Apparecchio LED per binario Eurotrack, con indice di resa cromatica CRI 95 per garantire la massima brillantezza dei colori.

LED luminaire for Eurotrack track, with CRI 95 color rendering index to ensure maximum color brilliance.



30 W dimmerabile con sistemi Trailing-Edge  
30 W dimmable with Trailing-Edge systems

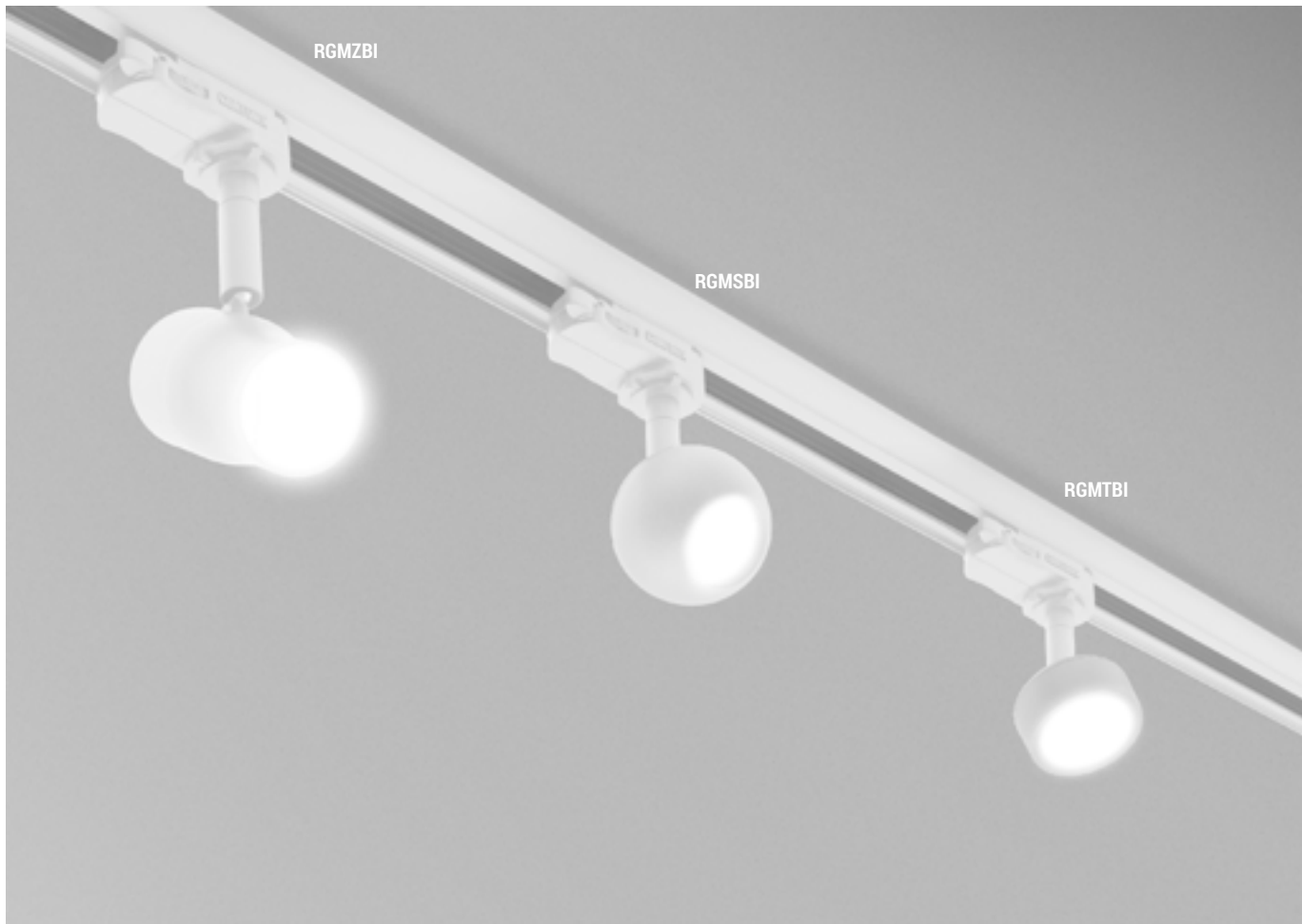

**NEW**

TRACK LIGHT

# REGIA MINI



**ZOOM**

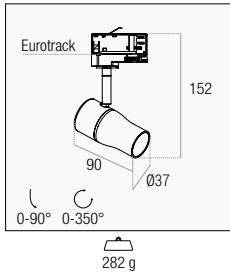

		OUTPUT							
12 W	770 lm	24° ∠	UGR<16 - CRI 90	Bianco / White ○	3000K		<b>RGMZBI-123730 NEW</b>	1/6	€ 70,00
	830 lm	24° ∠	UGR<16 - CRI 90	Bianco / White ○	4000K		<b>RGMZBI-123740 NEW</b>		
	770 lm	24° ∠	UGR<16 - CRI 90	Nero / Black ●	3000K		<b>RGMZNE-123730 NEW</b>		
	830 lm	24° ∠	UGR<16 - CRI 90	Nero / Black ●	4000K		<b>RGMZNE-123740 NEW</b>		



LENTE OPZIONALE / OPTIONAL LENS

15° ∠	<b>RGMZ-LENS15 NEW</b>	1/100	€ 2,20
-------	------------------------	-------	--------

**SPHERE**

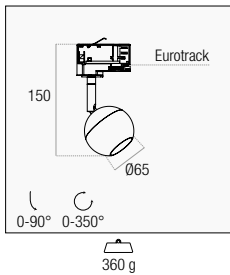

		OUTPUT							
10 W	760 lm	32° ∠	UG <16 - CRI 90	Bianco / White ○	3000K		<b>RGMSBI-106530 NEW</b>	1/6	€ 70,00
	850 lm	32° ∠	UGR<16 - CRI 90	Bianco / White ○	4000K		<b>RGMSBI-106540 NEW</b>		
	760 lm	32° ∠	UGR<16 - CRI 90	Nero / Black ●	3000K		<b>RGMSNE-106530 NEW</b>		
	850 lm	32° ∠	UGR<16 - CRI 90	Nero / Black ●	4000K		<b>RGMSNE-106540 NEW</b>		



LENTI OPZIONALI / OPTIONAL LENSES

15° ∠	<b>RGMS-LENS15 NEW</b>	1/100	€ 2,20
24° ∠	<b>RGMS-LENS24 NEW</b>		

**ROUND**

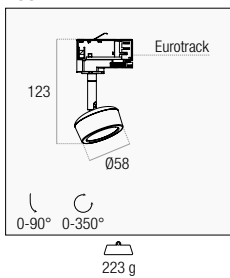

		OUTPUT							
7 W	440 lm	24° ∠	UGR<16 - CRI 90	Bianco / White ○	3000K		<b>RGMTBI-075830 NEW</b>	1/6	€ 59,00
	460 lm	24° ∠	UGR<16 - CRI 90	Bianco / White ○	4000K		<b>RGMTBI-075840 NEW</b>		
	440 lm	24° ∠	UGR<16 - CRI 90	Nero / Black ●	3000K		<b>RGMTNE-075830 NEW</b>		
	460 lm	24° ∠	UGR<16 - CRI 90	Nero / Black ●	4000K		<b>RGMTNE-075840 NEW</b>		



LENTE OPZIONALE / OPTIONAL LENS

15° ∠	<b>RGMT-LENS15 NEW</b>	1/100	€ 5,00
-------	------------------------	-------	--------

Apparecchi LED professionali per binario Eurotrack. La compattezza nel design dona allo spazio grande eleganza. Possibilità di personalizzare l'angolo luce.

Eurotrack Professional LED luminaires. Minimal design for great elegance. Adjustable beam angle.



DECORATIVO



W O R K  
W O R K  
**W O R K**  
W O R K  
W O R K







# WORK JOLLY



4 modalità di utilizzo  
4 operating modes



Pratica impugnatura  
Handy grip



Ricaricabile  
Rechargeable



Pulsante multifunzione  
Multifunction button



Indicatore stato batteria  
Battery status indicator



Funzione Powerbank  
Powerbank function

Disponibile nelle versioni / Available in versions  
30 W - 50 W

NEW

WORK

# JOLLY

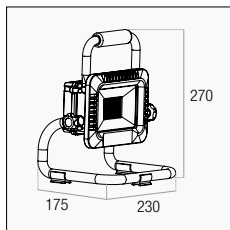

1170 g

30 W	2550 lm	120° ∠	Li-Ion 3,7 V/DC 8.800 mAh*	4000K	<b>JL-308540 NEW</b>	1/8	€ 96,00
50 W	4250 lm	120° ∠	Li-Ion 11,1 V/DC 4.400 mAh*	4000K	<b>JL-508540 NEW</b>	1/8	€ 151,00

Ricarica ~6 h / Autonomia fino a 12 h  
Charging ~6 h / Autonomy up to 12 h



Powerbank  
1 USB

Faro LED ricaricabile ad alta potenza.  
4 modalità di funzionamento.  
Autonomia fino a 12h.  
Controllo livello batteria tramite LED sul retro.

High power rechargeable LED headlight.  
4 operating modes. Autonomy up to 12h.  
LED battery level control on the rear.



4 modalità di funzionamento  
4 operating modes

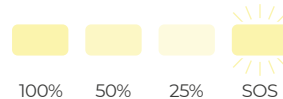

100% 50% 25% SOS



30 W

Incluso adattatore da parete e cavo micro USB  
Including wall adapter and micro USB cable



50 W

Incluso alimentatore domestico 230 V/AC  
230 V / AC domestic power supply included

WORK  
**FOCUS**



30 W

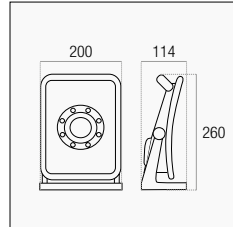

1100 g

30 W	2.800 lm	110° ∠	4000K	<b>FC-309540</b>	1/6	€ 77,00
------	----------	--------	-------	------------------	-----	---------

Cavo in neoprene H07RN-F da 1,8 metri e spina Schuko 2P+T 16A  
1,8 mt H07RN-F neoprene cable and 2P+T 16A Schuko plug



50 W - 80 W

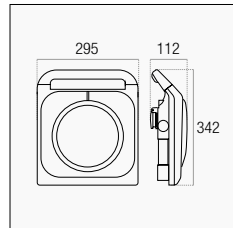

3600 g

50 W	5.000 lm	110° ∠	4000K	<b>FC-509540</b>	1/4	€ 14,00
80 W	8.000 lm	110° ∠	4000K	<b>FC-809540</b>	1/4	€ 173,00

Cavo in neoprene H07RN-F da 3 metri e spina Schuko 2P+T 16A  
3 mt H07RN-F neoprene cable and 2P+T 16A Schuko plug

FOCUS 30 W



1 presa di servizio IP54 Schuko 2P+T 16A  
1 service socket IP54 Schuko 2P+T 16A

FOCUS 50 W - 80 W



2 prese di servizio IP54 Schuko 2P+T 16A  
2 service sockets IP54 Schuko 2P+T 16A

Proiettore portatile alimentato da rete elettrica. Corpo in alluminio pressofuso, ottica antiabbaglio, protezione in gomma antiurto. Staffa regolabile.

Portable floodlight powered by mains. Die-cast aluminum body, anti-glare optics, rubber shockproof protection. Adjustable bracket.



Proiettore portatile alimentato da rete elettrica. Corpo in plastica antishock, ottica antiabbaglio, ampio dissipatore in alluminio pressofuso. Staffa regolabile.

Portable floodlight powered by mains. Shockproof plastic body, anti-glare optics, large die-cast aluminum heat sink. Adjustable bracket.

# WORK REWORK



PROIETTORE CON MANICO / FLOODLIGHT WITH HANDLE

	A mm	B mm	C mm	g
30W	250	250	180	1300
50W	292	280	180	1700
70W	340	370	190	2170
100W	400	430	250	3000

30 W	2.530 lm	120° ∠	4000K	RW-308540	1/4	€ 48,00
50 W	4.425 lm	120° ∠	4000K	RW-508540	1/4	€ 65,00
70 W	5.990 lm	120° ∠	4000K	RW-708540	1/4	€ 94,00
100 W	8.350 lm	120° ∠	4000K	RW-1008540	1/4	€ 118,00

Cavo in neoprene da 1,5 metri e spina Schuko  
1,5 mt H07RN-F neoprene cable and Schuko plug



2 PROIETTORI CON TREPPIEDI / 2 FLOODLIGHTS WITH TRIPOD

	A mm	B mm	C mm	g
60W	176	159	33	580
100W	218	203	35	920

	A mm	B1-B2 mm	g
60W	527	770 - 1600	3560
100W	568	810 - 1640	4240

60 W	5.400 lm	120° ∠	4000K	RWT2-608540	1/2	€ 94,00
100 W	8.850 lm	120° ∠	4000K	RWT2-1008540	1/2	€ 118,00

Precablato con cavo in neoprene da 2,5 metri e spina Schuko  
Pre-wired with 2,5 mt H05RN-F neoprene cable and Schuko plug



## REWORK

Impugnatura ergonomica  
Ergonomic handle



Staffa regolabile  
Adjustable bracket

Ottica antiabbaglio  
Anti-glare optics

## REWORK TREPPIEDI / TRIPOD

Altezza e proiettori regolabili  
Adjustable floodlights and height



Proiettore portatile alimentato da rete elettrica. Corpo in alluminio pressofuso con vernice epossidica.

Portable floodlight powered by mains. Die-cast aluminum body with epoxy paint.



Treppiedi in alluminio con 2 proiettori. Altezza regolabile, proiettori ruotabili 360°.

Aluminum tripod with 2 floodlights. Adjustable height, 360° rotatable floodlights.





WORK  
WORK  
WORK  
WORK

TRIP0D160

WORK

# FREE WORK

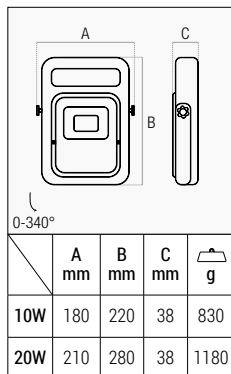

10 W	750 lm	120° ∠	4000K	<b>FRW-100040</b>	1/20	€ 37,00
20 W	1.500 lm	120° ∠	4000K	<b>FRW-200040</b>	1/10	€ 46,00

Cavo in neoprene da 2 metri e spina Schuko  
2 mt neoprene cable and Schuko plug

Proiettore portatile alimentato da rete elettrica. Grazie alla sua solida struttura e comoda impugnatura risulta essere maneggevole per qualunque utilizzo.

Portable floodlight powered by mains. Solid structure and comfortable grip, easy to handle for any use.



Pratica impugnatura  
Handy grip



Staffa regolabile 0-90°  
0-90° Adjustable

Vetro temperato  
Tempered glass

Orientabile 0-340°  
0 - 340° Adjustable

## SUPPORTI PER PROIETTORI SUPPORTS FOR PROJECTORS

### STAND

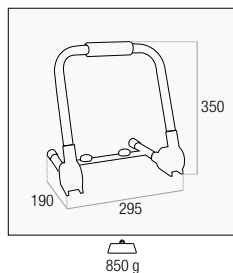

**STAND50** 1/5 € 26,00



### TREPIEDI / TRIPOD

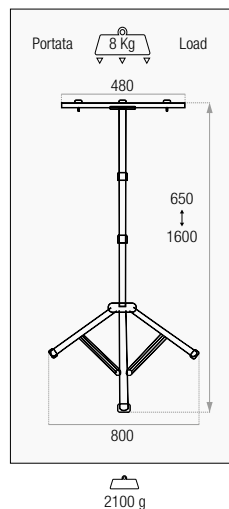

**TRIPOD160** 1/6 € 36,00



Regolabile in altezza  
Height adjustable

Supporto da terra orientabile. Struttura in metallo con impugnatura ergonomica. Installazione facile e veloce.

Adjustable ground support.  
Metal structure with ergonomic handle.  
Quick and easy installation.

Treppiedi ad alta stabilità. Predisposto per 2 faretti. Sicurezza ottimale.

High stability tripod.  
Fitted for 2 floodlights. Optimal safety.



SORGENTI  
SORGENTI  
**SORGENTI**  
SORGENTI  
SORGENTI

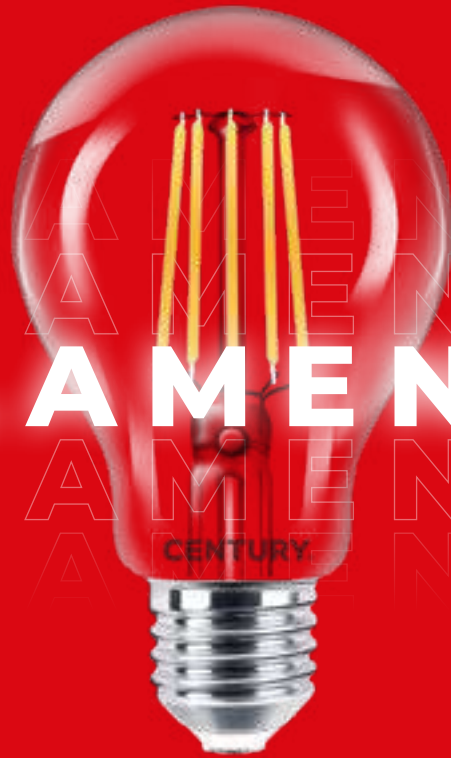

FILAMENTO  
FILAMENTO  
**FILAMENTO**  
FILAMENTO  
FILAMENTO

FILAMENT SOURCES  
FILAMENT SOURCES  
**FILAMENT SOURCES**  
FILAMENT SOURCES  
FILAMENT SOURCES

# Il nuovo packaging. Progettato nei minimi dettagli. The new packaging. Designed in the smallest detail.

Rosso CENTURY  
0% C 100% M 100% Y 5% K

Identità e riconoscibilità immediata  
Identity and immediate recognition

Foro cavaliere  
Suspension hole

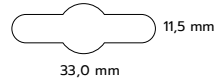

Multilingua  
Multiilingual

Etichetta energetica  
Energy label



Dati tecnici facilmente individuabili  
Easily identifiable technical data

Finestra prodotto non serve aprire la scatola  
Product window no need to open the box

Simbologia tecnica  
Technical symbols

Caratteristica distintiva  
Distinctive feature

EAN

Garanzia di qualità CENTURY  
CENTURY quality guarantee

Etichetta ambientale  
Environmental label

Riferimenti per restare in contatto  
References to keep in touch

HD Photo

Misure, peso e codice prodotto  
Measures, weight and product code

Attacco lampada  
Lamp socket

Banda colore luce  
Light color band

4W = **40w**

---

**470**  
lumen

---

**2700K**

CALDA WARM

Pulizia e chiarezza delle informazioni  
Cleanliness and clarity of information

Sceita guidata tramite scala colore  
Guided choice by color scale



SORCENTI







**Espositori che catturano.**  
Anche l'occhio vuole la sua parte.

**Catching installations.**  
Pleasant to the eye.

Progettazione personalizzata del layout espositivo. Tempi di allestimento sul posto minimizzati.  
Customized design of exhibition layout. Quick set-up on site.

**NEW**

SORGENTI - FILAMENTO

# INCANTO CLEAR

## Goccia



	A mm	B mm	g
4 W	Ø 60	108	33
8 W	Ø 60	108	33
11 W	Ø 60	108	33
16 W	Ø 75	140	55

E27	4 W = 40 W	470 lm	330° ∠	2700K	<b>ING3-042727</b>	10/50	€ 4,00
				4000K	<b>ING3-042740</b>		
E27	7 W = 60 W	806 lm	330° ∠	2700K	<b>ING3-082727</b>	10/50	€ 4,80
				4000K	<b>ING3-082740</b>		
E27	8 W = 75W	1.055 lm	330° ∠	2700K	<b>ING3P-082727</b>	10/50	€ 5,80
				4000K	<b>ING3P-082740</b>		
E27	11 W = 100 W	1.521 lm	330° ∠	2700K	<b>ING3-122727 NEW</b>	10/50	€ 7,00
				4000K	<b>ING3-122740 NEW</b>		
E27	16 W = 140 W	2.300 lm	330° ∠	2700K	<b>ING3-162727</b>	10/50	€ 16,00
				4000K	<b>ING3-162740</b>		

11W - 16W

Lampade a filamento LED in vetro trasparente per un'illuminazione diffusa a 330°.

Transparent glass LED filament lamps with 330° diffused lighting.



**NEW**

SORGENTI - FILAMENTO

# INCANTO SATEN

## Goccia



	A mm	B mm	g
4 W	Ø 60	108	33
8 W	Ø 60	108	33
11 W	Ø 60	108	33
16 W	Ø 75	140	55

E27	4 W = 40 W	470 lm	330° ∠	2700K	<b>INSG3-042730 NEW</b>	10/50	€ 4,10
				4000K	<b>INSG3-042740 NEW</b>		
				6500K	<b>INSG3-042760 NEW</b>		
	7 W = 60 W	806 lm	330° ∠	3000K	<b>INSG3-082730</b>	10/50	€ 4,80
				4000K	<b>INSG3-082740</b>		
				6500K	<b>INSG3-082760</b>		
	8 W = 75 W	1.055 lm	330° ∠	3000K	<b>INSG3P-082730</b>	10/50	€ 5,80
				4000K	<b>INSG3P-082740</b>		
				6500K	<b>INSG3P-082760</b>		
	11 W = 100 W	1.521 lm	330° ∠	3000K	<b>INSG3-122730 NEW</b>	10/50	€ 7,00
				4000K	<b>INSG3-122740 NEW</b>		
				6500K	<b>INSG3-122760 NEW</b>		
16 W = 140 W	2.300 lm	330° ∠	3000K	<b>INSG3-162730</b>	10/50	€ 16,00	
			4000K	<b>INSG3-162740</b>			
			6500K	<b>INSG3-162760</b>			

11W - 16W

Lampade a filamento LED in vetro opale per un'illuminazione morbida e diffusa.

Opal LED filament lamps with soft and diffused light.





**NEW**

SORGENTI - FILAMENTO

# INCANTO CLEAR

## Globo



		A		B	
		mm		mm	
		A		B	
		mm		mm	
		g			
8 W	Ø 95	140	50		
10 W	Ø 125	174	103		
11 W	Ø 125	170	100		
16 W	Ø 125	170	100		

E27	8 W = 75 W	1.055 lm	330° ∠	2700K	<b>ING95-082727</b>	5/20	€ 9,50
				4000K	<b>ING95-082740</b>		
	10 W = 100 W	1.521 lm	330° ∠	2700K	<b>ING125-102727</b>	5/20	€ 13,00
				6000K	<b>ING125-102760</b>		
	11 W = 100 W	1.521 lm	330° ∠	3000K	<b>ING125-122727 NEW</b>	5/20	€ 13,00
				4000K	<b>ING125-122740 NEW</b>		
6500K				<b>ING125-122760 NEW</b>			
16 W = 140 W	2.300 lm	330° ∠	2700K	<b>ING125-162727</b>	5/20	€ 20,00	
			4000K	<b>ING125-162740</b>			



Lampade a filamento LED in vetro trasparente per un'illuminazione diffusa a 330°.

Transparent glass LED filament lamps with 330° diffused lighting.



**NEW**

SORGENTI - FILAMENTO

# INCANTO SATEN

## Globo



	A	B	g
	mm	mm	
8 W	Ø 95	140	50
10 W	Ø 125	174	103
11 W	Ø 125	170	100
16 W	Ø 125	170	100

E27	8 W = 75 W	1.055 lm	330° ∠	3000K	<b>INSG95-082730 NEW</b>	5/20	€ 9,50
				4000K	<b>INSG95-082740 NEW</b>		
				6500K	<b>INSG95-082760 NEW</b>		
	10 W = 100 W	1.521 lm	330° ∠	3000K	<b>INSG125-102730</b>	5/20	€ 13,00
				6000K	<b>INSG125-102760</b>		
	11 W = 100 W	1.521 lm	330° ∠	3000K	<b>INSG125-122730 NEW</b>	5/20	€ 13,00
				4000K	<b>INSG125-122740 NEW</b>		
				6500K	<b>INSG125-122760 NEW</b>		
	16 W = 140 W	2.300 lm	330° ∠	3000K	<b>INSG125-162730</b>	5/20	€ 20,00
				4000K	<b>INSG125-162740</b>		
				6500K	<b>INSG125-162760</b>		

**D** **E**  
11W - 16W

Lampade a filamento LED in vetro opale per un'illuminazione morbida e diffusa.

Opal LED filament lamps with soft and diffused light.



SORGENTI - FILAMENTO

# INCANTO CLEAR



Ø45 x 80  
13 g



## SFERA E14

E14	2 W = 25 W	250 lm	330° ∠	2700K	<b>INH1G-021427</b>	10/50	€ 3,20
				2700K	<b>INH1G-041427</b>		
	4 W = 40 W	470 lm	330° ∠	4000K	<b>INH1G-041440</b>	10/50	€ 3,80
				2700K	<b>INH1G-061427</b>		
	6 W = 60 W	806 lm	330° ∠	4000K	<b>INH1G-061440</b>	10/50	€ 4,80



Ø45 x 80  
19 g



## SFERA E27

E27	2 W = 25 W	250 lm	330° ∠	2700K	<b>INH1G-022727</b>	10/50	€ 3,20
				2700K	<b>INH1G-042727</b>		
	4 W = 40 W	470 lm	330° ∠	4000K	<b>INH1G-042740</b>	10/50	€ 3,80
				2700K	<b>INH1G-062727</b>		
	6 W = 60 W	806 lm	330° ∠	4000K	<b>INH1G-062740</b>	10/50	€ 4,80



Ø35 x 98  
14 g



## OLIVA

E14	2 W = 25 W	250 lm	330° ∠	2700K	<b>INM1-021427</b>	10/50	€ 3,20
				2700K	<b>INM1-041427</b>		
	4 W = 40 W	470 lm	330° ∠	4000K	<b>INM1-041440</b>	10/50	€ 3,80
				2700K	<b>INM1-061427</b>		
	6 W = 60 W	806 lm	330° ∠	4000K	<b>INM1-061440</b>	10/50	€ 4,80



Ø35 x 98  
14 g



## TORTIGLIONE

E14	4 W = 40 W	470 lm	330° ∠	2700K	<b>INTOR-041427</b>	10/50	€ 3,80
				4000K	<b>INTOR-041440</b>		
	6 W = 60 W	806 lm	330° ∠	2700K	<b>INTOR-061427</b>	10/50	€ 4,80
				4000K	<b>INTOR-061440</b>		



Ø37 x 118  
14 g



## COLPO DI VENTO

E14	2 W = 25 W	250 lm	330° ∠	2700K	<b>INM1C-021427</b>	10/50	€ 3,20
				2700K	<b>INM1C-041427</b>		
	4 W = 40 W	470 lm	330° ∠	4000K	<b>INM1C-041440</b>	10/50	€ 3,80



Lampade a filamento LED in vetro trasparente per un'illuminazione diffusa a 330°.

Transparent glass LED filament lamps with 330° diffused lighting.



# INCANTO SATEN



Ø45 x 80  
13 g



## SFERA E14

E14	4 W = 40 W	470 lm	330° ∠	3000K	<b>INSH1G-041430</b>	10/50	€ 3,80
				4000K	<b>INSH1G-041440</b>		
				6500K	<b>INSH1G-041460</b>		
	6 W = 60 W	806 lm	330° ∠	3000K	<b>INSH1G-061430</b>	10/50	€ 4,80
				4000K	<b>INSH1G-061440</b>		
				6500K	<b>INSH1G-061460</b>		



Ø45 x 80  
19 g



## SFERA E27

E27	4 W = 40 W	470 lm	330° ∠	3000K	<b>INSH1G-042730</b>	10/50	€ 3,80
				4000K	<b>INSH1G-042740</b>		
				6500K	<b>INSH1G-042760</b>		
	6 W = 60 W	806 lm	330° ∠	3000K	<b>INSH1G-062730</b>	10/50	€ 4,80
				4000K	<b>INSH1G-062740</b>		
				6500K	<b>INSH1G-062760</b>		



Ø35 x 98  
14 g



## OLIVA

E14	4 W = 40 W	470 lm	330° ∠	3000K	<b>INSM1-041430</b>	10/50	€ 3,80
				4000K	<b>INSM1-041440</b>		
				6500K	<b>INSM1-041460</b>		
	6 W = 60 W	806 lm	330° ∠	3000K	<b>INSM1-061430</b>	10/50	€ 4,80
				4000K	<b>INSM1-061440</b>		
				6500K	<b>INSM1-061460</b>		



Ø35 x 98  
14 g



## TORTIGLIONE

E14	4 W = 40 W	470 lm	330° ∠	3000K	<b>INSTOR-041430</b>	10/50	€ 3,80
				4000K	<b>INSTOR-041440</b>		
				6500K	<b>INSTOR-041460</b>		
	6 W = 60 W	806 lm	330° ∠	3000K	<b>INSTOR-061430</b>	10/50	€ 4,80
				4000K	<b>INSTOR-061440</b>		
				6500K	<b>INSTOR-061460</b>		



Ø37 x 118  
14 g



## COLPO DI VENTO

E14	4 W = 40 W	470 lm	330° ∠	3000K	<b>INSM1C-041430</b>	10/50	€ 3,80
				4000K	<b>INSM1C-041440</b>		
				6500K	<b>INSM1C-041460</b>		



Lampade a filamento LED in vetro opale per un'illuminazione morbida e diffusa.

Opal LED filament lamps with soft and diffused light.



**NEW**

SORGENTI - FILAMENTO

# INCANTO CLEAR

## Dimmerabile



Ø60 x 108  
333 g



### GOCCIA E27

E27	11 W	= 100 W	1.521 lm	330° ∠	Dimm.	2700K	<b>INDG3-112727 NEW</b>	10/50	€ 10,50
						4000K	<b>INDG3-112740 NEW</b>		



Ø45 x 80  
15 g



### SFERA E14

E14	6 W	= 60 W	806 lm	330° ∠	Dimm.	2700K	<b>INDH1G-061427 NEW</b>	10/50	€ 6,00
						4000K	<b>INDH1G-061440 NEW</b>		



Ø35 x 98  
14 g



### OLIVA E14

E14	6 W	= 60 W	806 lm	330° ∠	Dimm.	2700K	<b>INDM1-061427 NEW</b>	10/50	€ 6,00
						4000K	<b>INDM1-061440 NEW</b>		



Lampade a filamento LED dimmerabili in vetro trasparente per un'illuminazione diffusa a 330°.

Transparent glass dimmable LED filament lamps with 330° diffused lighting.



**NEW**

SORGENTI - FILAMENTO

# INCANTO SATEN

## Dimmerabile



Ø60 x 108  
333 g

**GOCCIA E27**

E27	11 W	= 100 W	1.521 lm	330° ∠	Dimm.	3000K	<b>INSDG3-112730 NEW</b>	10/50	€ 11,00
						4000K	<b>INSDG3-112740 NEW</b>		



Ø45 x 80  
15 g

**SFERA E14**

E14	6 W	= 60 W	806 lm	330° ∠	Dimm.	3000K	<b>INSDH1G-061430 NEW</b>	10/50	€ 6,70
						4000K	<b>INSDH1G-061440 NEW</b>		



Ø35 x 98  
14 g

**OLIVA E14**

E14	6 W	= 60 W	806 lm	330° ∠	Dimm.	3000K	<b>INSDM1-061430 NEW</b>	10/50	€ 6,70
						4000K	<b>INSDM1-061440 NEW</b>		



Lampade a filamento LED dimmerabili in vetro opale per un'illuminazione morbida e diffusa.

Opal dimmable LED filament lamps with soft and diffused light.





SORGENTI - FILAMENTO

# INCANTO Tubolare



E14	4 W    = 40 W    470 lm    330° ∠	2700K	<b>INTB-041427</b>	10/50	€ 4,30
		4000K	<b>INTB-041440</b>		
	7 W    = 75 W    1100 lm    330° ∠	2700K	<b>INTB-071427</b>	10/50	€ 5,30
		4000K	<b>INTB-071440</b>		

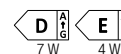

### CLEAR E27

E27	9 W    = 85 W    1200 lm    330° ∠	2700K	<b>INTB-092727</b>	10/50	€ 7,70
		4000K	<b>INTB-092740</b>		



### SATEN E14

E14	7 W    = 75 W    1100 lm    330° ∠	3000K	<b>INSTB-071430</b>	10/50	€ 5,30
		4000K	<b>INSTB-071440</b>		
		6500K	<b>INSTB-071460</b>		



### SATEN E27

E27	9 W    = 85 W    1.200 lm    330° ∠	3000K	<b>INSTB-092730</b>	10/50	€ 7,70
		4000K	<b>INSTB-092740</b>		
		6500K	<b>INSTB-092760</b>		



Lampade tubolari con innovativa tecnologia a filamento LED in vetro opale o trasparente.

Tubular lamps with innovative LED filament technology in opal or transparent glass.



SORGENTI - FILAMENTO

# INCANTO SATEN

## Saphir



	A mm	B mm	g
11 W	Ø 75	157	63
14 W	Ø 90	198	99
E40	Ø 90	208	104

E27	11 W = 100 W	1.300 lm	360° ∠	2200K	<b>SAPS-112722</b>	5/20	€ 18,00
		1.500 lm	360° ∠	2700K	<b>SAPS-112727</b>		
	14 W = 110 W	1.700 lm	360° ∠	2200K	<b>SAPS-142722</b>	5/20	€ 22,00
E40	14 W = 110 W	1.700 lm	360° ∠	2200K	<b>SAPS-144022</b>	5/20	€ 23,00

A+

Simile nelle forme alle tradizionali SAP, garantisce un'ottima prestazione luminosa per ogni tipo di ambiente.

Similar shape to traditional SAPs, for excellent lighting performance suitable for every kind of ambience.

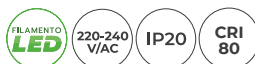



# INCANTO **SILVER**



Versione E27  
E27 Version



Versione E14  
E14 Version



Cupola argentata  
Silver dome



NO abbagliamento  
NO glare



NO dispersione  
NO dispersion



Dimmerabile  
Dimmable

Disponibile nella versione: / Available versions:  
**Goccia - Sfera**

## RIFLETTE LA LUCE

Special cupola specchiata antiabbaglio per un ottimo comfort visivo.

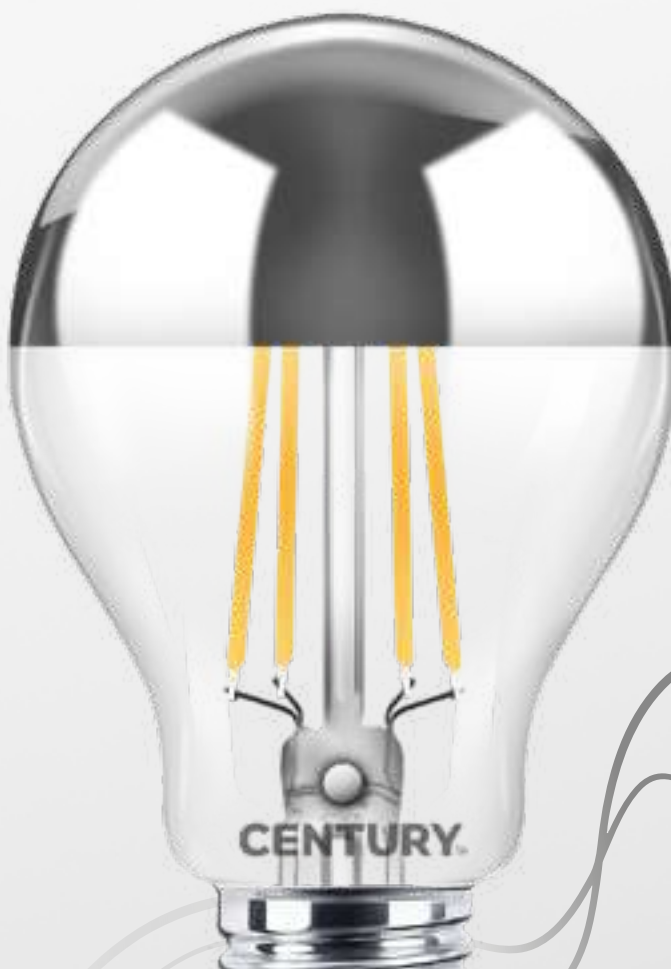

## REFLECTS THE LIGHT

Special antiglare mirror dome for a perfect visual comfort

**NEW**

SORGENTI - FILAMENTO

# INCANTO SILVER

## Dimmerabile



SFERA SILVER DOME

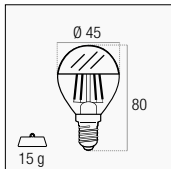

E14	6 W	= 60 W	680 lm	330° ∠	Dimm.	2700K	<b>INH1GSD-061427 NEW</b>	10/50	€ 7,00
-----	-----	--------	--------	--------	-------	-------	---------------------------	-------	--------



Dimmerabile con sistemi Trailing-Edge  
Dimmable with Trailing-Edge systems



GOCCIA SILVER DOME

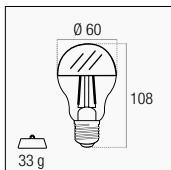

E27	8 W	= 60 W	900 lm	330° ∠	Dimm.	2700K	<b>ING3SD-082727 NEW</b>	10/50	€ 8,00
	11 W	= 100 W	1.350 lm	330° ∠	No Dimm.	2700K	<b>ING3S-112727 NEW</b>	10/50	€ 9,50



Dimmerabile con sistemi Trailing-Edge  
Dimmable with Trailing-Edge systems



Lampade a filamento LED in vetro trasparente con cupola argentata effetto specchio per una diffusione mirata della luce.

Clear glass LED filament lamps with mirror effect silver dome for focused light diffusion.

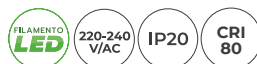

SORGENTI - FILAMENTO

# INCANTO EPOCA



Ø35 x 98  
14 g



## OLIVA

E14	4 W	= 30 W	400 lm	330° ∠	No Dimm.	2200K	INVM1-041422	10/50	€ 6,00
					Dimm.	2200K			



Dimmerabile con sistemi Trailing-Edge  
Dimmable with Trailing-Edge systems



Ø35 x 98  
14 g



## TORTIGLIONE

E14	4 W	= 30 W	400 lm	330° ∠	No Dimm.	2200K	INVTOR-041422	10/50	€ 6,00
-----	-----	--------	--------	--------	----------	-------	---------------	-------	--------



Ø37 x 118  
14 g



## COLPO DI VENTO

E14	4 W	= 30 W	400 lm	330° ∠	No Dimm.	2200K	INVM1C-041422	10/50	€ 6,00
-----	-----	--------	--------	--------	----------	-------	---------------	-------	--------



Ø60 x 106  
33 g



## GOCCIA

E27	8 W	= 60 W	806 lm	330° ∠	No Dimm.	2200K	INVG3-082722	10/50	€ 6,70
-----	-----	--------	--------	--------	----------	-------	--------------	-------	--------



Lampade dalla finitura ambrata che garantiscono un'atmosfera suggestiva.

Amber finish Lamps for a suggestive atmosphere.



SORGENTI - FILAMENTO

# INCANTO EPOCA



Ø64 x 140  
40 g



## EDISON

E27	8 W	= 60 W	806 lm	330° ∠	No Dimm.	2200K	<b>INVP-082722</b>	10/50	€ 8,00
	12 W	= 85 W	1.350 lm	330° ∠	Dimm.	2200K	<b>INVPD-122722 NEW</b>	10/50	€ 13,00



12 W dimmerabile con sistemi Trailing-Edge  
12 W dimmable with Trailing-Edge systems

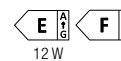

12 W



Ø125 x 170  
100 g



## GLOBO

E27	8 W	= 60 W	806 lm	330° ∠	No Dimm.	2200K	<b>INVG125-082722</b>	5/20	€ 19,00
	10 W	= 60 W	806 lm	330° ∠	No Dimm.	2200K	<b>INVG125-102722</b>	5/20	€ 21,00
	12 W	= 85 W	1.350 lm	330° ∠	Dimm.	2200K	<b>INVG125D-122722 NEW</b>	5/20	€ 24,00



12 W dimmerabile con sistemi Trailing-Edge  
12 W dimmable with Trailing-Edge systems

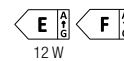

12 W



Ø160 x 320  
265 g

## GLOBO

E27	8 W	= 60 W	806 lm	360° ∠	Dimm.	2200K	<b>INVPS160-082722</b>	1/4	€ 77,00
-----	-----	--------	--------	--------	-------	-------	------------------------	-----	---------



Dimmerabile con sistemi Trailing-Edge  
Dimmable with Trailing-Edge systems



XL



Ø200 x 300  
366 g

## GLOBO

E27	8 W	= 60 W	806 lm	360° ∠	Dimm.	2200K	<b>INVG200-082722</b>	1/4	€ 79,00
-----	-----	--------	--------	--------	-------	-------	-----------------------	-----	---------



Dimmerabile con sistemi Trailing-Edge  
Dimmable with Trailing-Edge systems



Lampade dalla finitura ambrata che garantiscono un'atmosfera suggestiva.

Amber finish Lamps for a suggestive atmosphere.





SORGENTI  
SORGENTI  
**SORGENTI**  
SORGENTI  
SORGENTI

CLASSICHE  
CLASSICHE  
**CLASSICHE**  
CLASSICHE  
CLASSICHE

CLASSIC SOURCES  
CLASSIC SOURCES  
**CLASSIC SOURCES**  
CLASSIC SOURCES  
CLASSIC SOURCES

SORGENTI - CLASSICHE

# HARMONY 95

## Luce brillante / Brilliant light



Ø45 x 80  
23 g



### SFERA E14

E14	6 W	= 40 W	470 lm	180° ∠	CRI 95	2700K	HRH1G-061427	10/50	€ 4,80
-----	-----	--------	--------	--------	--------	-------	--------------	-------	--------



Ø45 x 80  
23 g



### SFERA E27

E27	6 W	= 40 W	470 lm	180° ∠	CRI 95	2700K	HRH1G-062727	10/50	€ 4,80
-----	-----	--------	--------	--------	--------	-------	--------------	-------	--------



Ø37 x 100  
21 g



### OLIVA

E14	6 W	= 40 W	470 lm	180° ∠	CRI 95	2700K	HRM1-061427	10/50	€ 4,80
-----	-----	--------	--------	--------	--------	-------	-------------	-------	--------



10 W  
Ø60 x 119  
58 g



12 W  
Ø60 x 119  
62 g

### GOCCIA

E27	10 W	= 60 W	806 lm	240° ∠	CRI 95	2700K	HRG3-102727	10/50	€ 6,00
	12 W	= 75 W	1.055 lm	240° ∠	CRI 95	2700K	HRG3-122727	10/50	€ 7,00



Ottima resa cromatica e massima brillantezza luminosa grazie al CRI95.

Excellent color rendering and maximum brightness with CRI95.



SORGENTI - CLASSICHE

# HARMONY 80



Ø45 x 80  
23 g



## SFERA E14

E14	4 W	= 30 W	350 lm	200° ∠	3000K	<b>HR80H1G-041430</b>	10/50	€ 1,90
					4000K	<b>HR80H1G-041440</b>		
					6500K	<b>HR80H1G-041464</b>		



Ø45 x 80  
23 g



## SFERA E27

E27	4 W	= 30 W	350 lm	200° ∠	3000K	<b>HR80H1G-042730</b>	10/50	€ 1,90
					4000K	<b>HR80H1G-042740</b>		
					6500K	<b>HR80H1G-042764</b>		



Ø37 x 100  
21 g



## OLIVA

E14	4 W	= 30 W	350 lm	220° ∠	3000K	<b>HR80M1-041430</b>	10/50	€ 1,90
					4000K	<b>HR80M1-041440</b>		
					6500K	<b>HR80M1-041464</b>		



9 W - 11 W  
Ø60 x 108  
30 g

15 W  
Ø60 x 123  
40 g

17 W  
Ø65 x 120  
90 g



## GOCCIA

E27	9 W	= 60 W	806 lm	200° ∠	3000K	<b>HR80G3-092730</b>	10/50	€ 3,00
					4000K	<b>HR80G3-092740</b>		
					6500K	<b>HR80G3-092764</b>		
	11 W	= 75 W	1.055 lm	200° ∠	3000K	<b>HR80G3-112730</b>	10/50	€ 3,50
					4000K	<b>HR80G3-112740</b>		
					6500K	<b>HR80G3-112764</b>		
	15 W	= 100 W	1.521 lm	200° ∠	3000K	<b>HR80G3-152730</b>	10/50	€ 6,00
					4000K	<b>HR80G3-152740</b>		
					6500K	<b>HR80G3-152764</b>		
17 W	= 100 W	1.921 lm	180° ∠	3000K	<b>HR80G3-172730</b>	10/50	€ 6,50	
				4000K	<b>HR80G3-172740</b>			
				6500K	<b>HR80G3-172764</b>			



Massima qualità della luce e possibilità di scelta tra diverse temperature di colore luce.

Maximum light quality and choice between different light color temperatures.



**NEW**

SORGENTI - CLASSICHE

# HARMONY 80



GLOBO

	A mm	B mm	g
15 W	Ø95	143	78
20 W	Ø120	163	143
24 W	Ø120	163	173
24 W Dimm	Ø125	173	150

E27	15 W	= 90 W	1.490 lm	220° ∠	No Dimm.	3000K	HR80G95-152730	6/24	€ 9,50	
						4000K	HR80G95-152740			
6000K	HR80G95-152760									
E27	20 W	= 120 W	2.100 lm	220° ∠	No Dimm.	3000K	HR80G120-202730	6/24	€ 12,00	
						4000K	HR80G120-202740			
						6000K	HR80G120-202760			
E27	24 W	= 130 W	2.500 lm	220° ∠	No Dimm.	3000K	HR80G120-242730	6/24	€ 15,00	
						4000K	HR80G120-242740			
						6000K	HR80G120-242760			
	E27	24 W	= 130 W	2.200 lm	260° ∠	Dimm.	3000K	HRDG125-242730 <b>NEW</b>	6/24	€ 18,00
							4000K	HRDG125-242740 <b>NEW</b>		
							6000K	HRDG125-242760 <b>NEW</b>		



HRDG125 Dimmerabile con sistemi Trailing-Edge  
HRDG125 Dimmable with Trailing-Edge systems



SORGENTI

Massima qualità della luce e possibilità di scelta tra diverse temperature di colore luce.

Maximum light quality and choice between different light color temperatures.

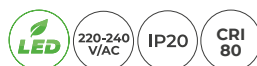

# ONDA



6 W 045 x 80 23 g  
8 W 045 x 80 33 g

## SFERA E14

E14	6 W = 40 W	490 lm	200° ∠	3000K	<b>ONH1G-061430</b>	10/50	€ 2,60
				4000K	<b>ONH1G-061440</b>		
				6500K	<b>ONH1G-061465</b>		
	8 W = 60 W	806 lm	180° ∠	3000K	<b>ONH1G-081430</b>	10/50	€ 3,50
				4000K	<b>ONH1G-081440</b>		
				6500K	<b>ONH1G-081465</b>		



6 W 045 x 80 23 g  
8 W 045 x 80 33 g

## SFERA E27

E27	6 W = 40 W	490 lm	200° ∠	3000K	<b>ONH1G-062730</b>	10/50	€ 2,60
				4000K	<b>ONH1G-062740</b>		
				6500K	<b>ONH1G-062765</b>		
	8 W = 60 W	806 lm	180° ∠	3000K	<b>ONH1G-082730</b>	10/50	€ 3,50
				4000K	<b>ONH1G-082740</b>		
				6500K	<b>ONH1G-082765</b>		

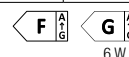

6 W 037 x 100 20 g  
8 W 037 x 106 30 g

## OLIVA

E14	6 W = 40 W	490 lm	220° ∠	3000K	<b>ONM1-061430</b>	10/50	€ 2,60
				4000K	<b>ONM1-061440</b>		
				6500K	<b>ONM1-061465</b>		
	8 W = 60 W	806 lm	220° ∠	3000K	<b>ONM1-081430</b>	10/50	€ 3,50
				4000K	<b>ONM1-081440</b>		
				6500K	<b>ONM1-081465</b>		



037 x 124 23 g

## COLPO DI VENTO

E27	6 W = 40 W	490 lm	220° ∠	3000K	<b>ONM1C-061430</b>	10/50	€ 2,60
				4000K	<b>ONM1C-061440</b>		
				6500K	<b>ONM1C-061465</b>		



Massima qualità della luce e possibilità di scelta tra diverse temperature di colore luce.

Maximum light quality and choice between different light color temperatures.



**NEW**

# SORGENTI - CLASSICHE

## ARIA PLUS

**3 YEARS**  
WARRANTY



**7 W - 10W**    **12 W**    **15 W**  
 Ø60 x 129    Ø60 x 120    Ø60 x 129  
 130 g    109 g    96 g

### GOCCIA

E27	7 W	= 50 W	648 lm	270° ∠	No Dimm.	3000K	<b>ARP-072730</b>	10/50	€ 5,00	
						6400K	<b>ARP-072764</b>			
	10 W	= 65 W	882 lm	270° ∠	No Dimm.	3000K	<b>ARP-102730</b>	10/50	€ 6,00	
						4000K	<b>ARP-102740</b>			
		12 W	= 75 W	1.068 lm	220° ∠	No Dimm.	3000K	<b>ARP-122730</b>	10/50	€ 7,00
							4000K	<b>ARP-122740</b>		
		15 W	= 100 W	1.521 lm	270° ∠	No Dimm.	3000K	<b>ARP-152730</b>	10/50	€ 8,00
							6400K	<b>ARP-152764</b>		

**A+**



**20 W**    **20 W Dimm.**  
 Ø65 x 133    Ø65 x 133  
 83 g    85 g

### GOCCIA 20 W

E27	20 W	= 150 W	2.450 lm	180° ∠	No Dimm.	3000K	<b>ARP-202730</b>	10/50	€ 9,00	
						4000K	<b>ARP-202740</b>			
						6500K	<b>ARP-202765</b>			
		20 W	= 140 W	2.300 lm	180° ∠	Dimm.	3000K	<b>ARPD-202730 NEW</b>	10/50	€ 11,50
							4000K	<b>ARPD-202740 NEW</b>		
							6500K	<b>ARPD-202765 NEW</b>		



ARPD Dimmerabile con sistemi Trailing-Edge  
 ARPD Dimmable with Trailing-Edge systems

**E**

Massima qualità della luce e possibilità di scelta tra diverse temperature di colore luce.

Maximum light quality and choice between different light color temperatures.





SORGENTI  
SORGENTI  
**SORGENTI**  
SORGENTI  
SORGENTI

S POT  
S POT  
**S POT**  
S POT  
S POT

SPOT SOURCES  
SPOT SOURCES  
**SPOT SOURCES**  
SPOT SOURCES  
SPOT SOURCES

**NEW**

SORGENTI - SPOT  
**LEXAR**



6 W 050 x 54 31 g  
8 W 050 x 54 41 g



35°

GU10	5 W = 40 W 380 lm 35° ∠ 220-240 V/AC 50/60 Hz	3000K	<b>LX38-061030</b>	10/50	€ 4,00
		4000K	<b>LX38-061040</b>		
		6000K	<b>LX38-061060</b>		
	6,5 W = 50 W 500 lm 35° ∠ 220-240 V/AC 50/60 Hz	3000K	<b>LX38-081030</b>	10/50	€ 4,80
		4000K	<b>LX38-081040</b>		
		6000K	<b>LX38-081060</b>		

F A G



050 x 54 31 g



105°

GU10	5 W = 40 W 380 lm 105° ∠ 220-240 V/AC 50/60 Hz	3000K	<b>LX110-061030</b>	10/50	€ 4,00
		4000K	<b>LX110-061040</b>		
		6500K	<b>LX110-061060</b>		
	6,5 W = 50 W 570 lm 105° ∠ 220-240 V/AC 50/60 Hz	3000K	<b>LX110-081030</b>	10/50	€ 4,80
		4000K	<b>LX110-081040</b>		
		6500K	<b>LX110-081060</b>		

F A G



050 x 53 70 g



110° CERAMIC

GU10	9 W = 60 W 800 lm 110° ∠ 220-240 V/AC 50/60 Hz	3000K	<b>LXC110-091030 NEW</b>	10/50	€ 7,50
		4000K	<b>LXC110-091040 NEW</b>		
		6000K	<b>LXC110-091060 NEW</b>		

Corpo in ceramica per una dissipazione ottimale ed una maggiore durata.  
Ceramic body for optimal dissipation and longer life.

F A G



050 x 46 26 g



60°

GU5.3	5 W = 40 W 350 lm 60° ∠ 12 V AC/DC 50/60 Hz	3000K	<b>LX60-065330</b>	10/50	€ 6,00
		4000K	<b>LX60-065340</b>		
		6000K	<b>LX60-065360</b>		
	6,5 W = 50 W 450 lm 60° ∠ 12 V AC/DC 50/60 Hz	3000K	<b>LX60-085330</b>	10/50	€ 7,00
		4000K	<b>LX60-085340</b>		
		6000K	<b>LX60-085360</b>		

Alimentazione con trasformatori elettromagnetici e non elettronici.  
Power supply with electromagnetic and non-electronic transformers.

G A G

Disponibili in diverse temperature di colore luce, sono adatte sia per l'illuminazione d'accento che per quella generica.

Available in different light color temperatures and suitable for both accent lighting and general lighting.



SORGENTI - SPOT

# DICRO SHOP 95

## Dimmerabile



Ø50 x 54  
41 g

GU10	6 W	= 40 W	315 lm	35° ∠	CRI 95	3000K	<b>DSD-063830</b>	10/50	€ 8,00
						4000K	<b>DSD-063840</b>		
						6000K	<b>DSD-063860</b>		



Disponibile in diverse temperature di colore luce, adatta sia per l'illuminazione d'accento che per quella generica.

Available in different light color temperatures, and suitable for both lighting accent and the generic lighting solutions.



Dimmerabile con sistemi Trailing-Edge  
Dimmable with Trailing-Edge systems



Rende i colori rossi forti e brillanti.  
Makes red colors strong and bright.

SORGENTI - SPOT

# DICRO SHOP 90

## Dimmerabile



Ø50 x 54  
72 g

GU10	6,5 W	= 50 W	550 lm	12° ∠	CRI 95 - R9>50	3000K	<b>DSD-061230</b>	10/50	€ 20,00
						4000K	<b>DSD-061240</b>		
			650 lm	12° ∠	CRI 95 - R9>50	6000K	<b>DSD-061260</b>		

Corpo in alluminio ad alto spessore per maggiore dissipazione  
High thickness aluminum body for greater dissipation



Lampada spot GU10 professionale ideale per illuminazione d'accento. Realizzata in alluminio ad alto spessore e dotata di un'ottica ad alto rendimento con fascio di 12°.

Professional GU10 spot lamp ideal for accent lighting. High-thickness aluminum body equipped with a high-performance optic with 12° beam angle.



Ottica studiata per un'elevata concentrazione del fascio luminoso  
Optics designed for a high concentration of the light beam

SORGENTI - SPOT

# SPOT MULTILED



GU10	7 W	= 50 W	600 lm	110° ∠	3000K <span style="color: yellow;">■</span>	<b>K2T7LED-071030</b>	6/24	€ 3,40
					4000K <span style="color: green;">■</span>	<b>K2T7LED-071040</b>		
					6500K <span style="color: blue;">■</span>	<b>K2T7LED-071060</b>		



Disponibile in diverse temperature di colore luce, adatta sia per l'illuminazione d'accento che per quella generica.

Available in different light color temperatures, and suitable for both lighting accent and the generic lighting solutions.



SORGENTI - SPOT

# SPOT MAXILED



MR11	3 W	= 20 W	240 lm	30° ∠	3000K <span style="color: yellow;">■</span>	<b>K12XLED-300430</b>	6/24	€ 11,00
					4000K <span style="color: green;">■</span>	<b>K12XLED-300440</b>		

Alimentazione con trasformatori elettromagnetici e non elettronici.  
Power supply with electromagnetic and non-electronic transformers.



Disponibile in diverse temperature di colore luce, adatta sia per l'illuminazione d'accento che per quella generica.

Available in different light color temperatures, and suitable for both lighting accent and the generic lighting solutions.





SORGENTI  
SORGENTI  
**SORGENTI**  
SORGENTI  
SORGENTI

SPECIALI  
SPECIALI  
**SPECIALI**  
SPECIALI  
SPECIALI

SPECIAL SOURCES  
SPECIAL SOURCES  
**SPECIAL SOURCES**  
SPECIAL SOURCES  
SPECIAL SOURCES





SORGENTI - SPECIALI

# PIXY G4



Ø14 x 51  
10 g



### COB 2 W

G4	2 W	= 20 W	200 lm	300° ∠	12 V AC/DC 50/60 Hz	3000K	<b>PIXYCOB-020430</b>	12/96	€ 5,00
						4000K	<b>PIXYCOB-020440</b>		
						6500K	<b>PIXYCOB-020464</b>		



Ø30 x 43  
4 g



### PLATE 2 W

G4	2 W	= 20 W	170 lm	180° ∠	12 V AC/DC 50/60 Hz	3000K	<b>PIXYPLT-020430</b>	12/96	€ 5,00
----	-----	--------	--------	--------	---------------------	-------	-----------------------	-------	--------



Ø16 x 45  
10 g



### 3 W

G4	3 W	= 30 W	300 lm	300° ∠	12 V AC/DC 50/60 Hz	3000K	<b>PIXYFULL-030430</b>	12/96	€ 6,00
						4000K	<b>PIXYFULL-030440</b>		
						6500K	<b>PIXYFULL-030464</b>		



Ø16 x 57  
13 g



### 4,5 W

G4	4,5 W	= 40 W	460 lm	360° ∠	12 V AC/DC 50/60 Hz	3000K	<b>PIXYFULL-450430</b>	12/96	€ 7,00
						4000K	<b>PIXYFULL-450440</b>		
						6400K	<b>PIXYFULL-450464</b>		



Design trasparente ed elegante. Si alimenta con trasformatore elettromagnetici e non elettronici.

Transparent and elegant design. Powered by electromagnetic and non-electronic transformers.



SORGENTI - SPECIALI

# PIXY G9



Ø15 x 44  
11 g



### 3 W

G9	3 W	= 30 W	270 lm	300° ∠	3000K	<b>PIXYFULL-030930</b>	12/96	€ 4,30
					4000K	<b>PIXYFULL-030940</b>		
					6500K	<b>PIXYFULL-030964</b>		



Ø16 x 60  
14 g



### 4 W

G9	4 W	= 40 W	450 lm	300° ∠	3000K	<b>PIXYFULL-040930</b>	12/96	€ 5,00
					4000K	<b>PIXYFULL-040940</b>		
					6500K	<b>PIXYFULL-040964</b>		



Ø14 x 64  
10 g



### COB 4 W

G9	4 W	= 40 W	440 lm	300° ∠	3000K	<b>PIXYCOB-040930</b>	12/96	€ 6,00
					4000K	<b>PIXYCOB-040940</b>		
					6500K	<b>PIXYCOB-040964</b>		



Ø16 x 60  
15 g



### 5 W

G9	5 W	= 40 W	500 lm	330° ∠	3000K	<b>PIXYFULL-050930</b>	12/96	€ 6,20
					4000K	<b>PIXYFULL-050940</b>		
					6500K	<b>PIXYFULL-050964</b>		



Ø16 x 75  
22 g



### 8 W

G9	8 W	= 60 W	800 lm	330° ∠	3000K	<b>PIXYFULL-080930</b>	12/96	€ 7,50
					4000K	<b>PIXYFULL-080940</b>		
					6500K	<b>PIXYFULL-080964</b>		



Design trasparente ed elegante. Si alimenta con corrente a 220 V (senza trasformatore).

Transparent and elegant design. Powered by 220 V current (without transformer).



**NEW**

SORGENTI - SPECIALI

# PIXY

## Dimmerabile



	A mm	B mm	g
4 W	Ø 18	55	15
6,5 W	Ø 21	70	25

G9	4 W	=35 W	350 lm	330° ∟	Blister - Dimm.	3000K	<b>PIXYDIM-450930 NEW</b>	12/96	€ 8,00
						4000K	<b>PIXYDIM-450940 NEW</b>		
						6000K	<b>PIXYDIM-450960 NEW</b>		
	6,5 W	=50 W	600 lm	330° ∟	Blister - Dimm.	3000K	<b>PIXYDIM-650930 NEW</b>	12/96	€ 9,00
						4000K	<b>PIXYDIM-650940 NEW</b>		
						6000K	<b>PIXYDIM-650960 NEW</b>		

**F**

Lampada LED G9, trasparente e dimmerabile.  
Transparent and dimmable G9 LED lamp.



**NEW**

SORGENTI - SPECIALI

# TRE-D



6 W 11 W  
 Ø16 x 78 Ø16 x 118  
 11 g 15 g

## TRE-D COB

R7s	6 W	=40 W	615 lm	360° ∠	Color Box	3000K	<b>TRCOB-057830 NEW</b>	6/24	€ 13,00
						4000K	<b>TRCOB-057840 NEW</b>		
		=60 W	750 lm	360° ∠	Blister	3000K	<b>TRCOB-057830BL NEW</b>		
						4000K	<b>TRCOB-057840BL NEW</b>		
	11 W	=75 W	1.180 lm	360° ∠	Color Box	3000K	<b>TRCOB-1011830 NEW</b>	6/24	€ 16,00
						4000K	<b>TRCOB-1011840 NEW</b>		
1.220 lm		360° ∠	Blister	3000K	<b>TRCOB-1011830BL NEW</b>				
				4000K	<b>TRCOB-1011840BL NEW</b>				

Tecnologia COB  
 COB technology



Ø29 x 118  
 70 g

## TRE-D

R7s	12 W	= 120 W	1.600 lm	360° ∠	Blister - Dimm.	3000K	<b>TRD-1211830BL</b>	6/24	€ 24,00
						4000K	<b>TRD-1211840BL</b>		
	14 W	= 120 W	1.550 lm	300° ∠	Blister - No Dimm.	3000K	<b>TR-1511830BL</b>	6/24	€ 19,00
						4000K	<b>TR-1511840BL</b>		

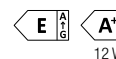

12 W



5 W 8 W  
 Ø15 x 78 Ø15 x 118  
 23 g 35 g

## TRE-D SLIM

R7s	5 W	= 50 W	470 lm	330° ∠	Blister	3000K	<b>TRS-058730BL</b>	6/24	€ 10,00
	9 W	= 70 W	950 lm	330° ∠	Blister	3000K	<b>TRS-0811830BL</b>	6/24	€ 13,00

Ultraslim



Lampada LED R7S. Elevate prestazioni in dimensioni ridotte.

R7S LED lamp. High performance in short size.



SORGENTI - SPECIALI

# ARIA PLUS

## 12-24 V AC/DC

12-24 V  
AC/DC

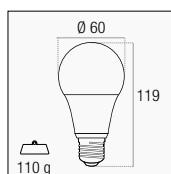

E27	12 W	= 85 W	1.280 lm	270° ∠	3000K	ARP-122430	10/50	€ 14,00
					4000K			

F A G

Lampada a bassa tensione con range di utilizzo 12-24 V AC/DC. Un prodotto versatile che garantisce massima qualità della luce.

Low voltage lamp with 12-24 V AC / DC range. A versatile product for maximum light quality.



SORGENTI - SPECIALI

# SENSOR

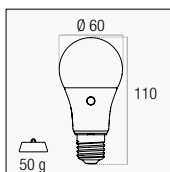

E27	11 W = 75 W	1.050 lm	200° ∠	Auto On-Off	3000K	<b>G3SP-102730</b>	6/24	€ 13,00
					6400K	<b>G3SP-102764</b>		

Doppio sensore crepuscolare  
Double Light sensor



L'On-Off automatico giorno-notte consente di risparmiare con un'illuminazione intelligente.

Automatic day-night On-Off to saving power for an intelligent lighting.



On-Off automatico giorno-notte  
Automatic day-night on-off

SORGENTI



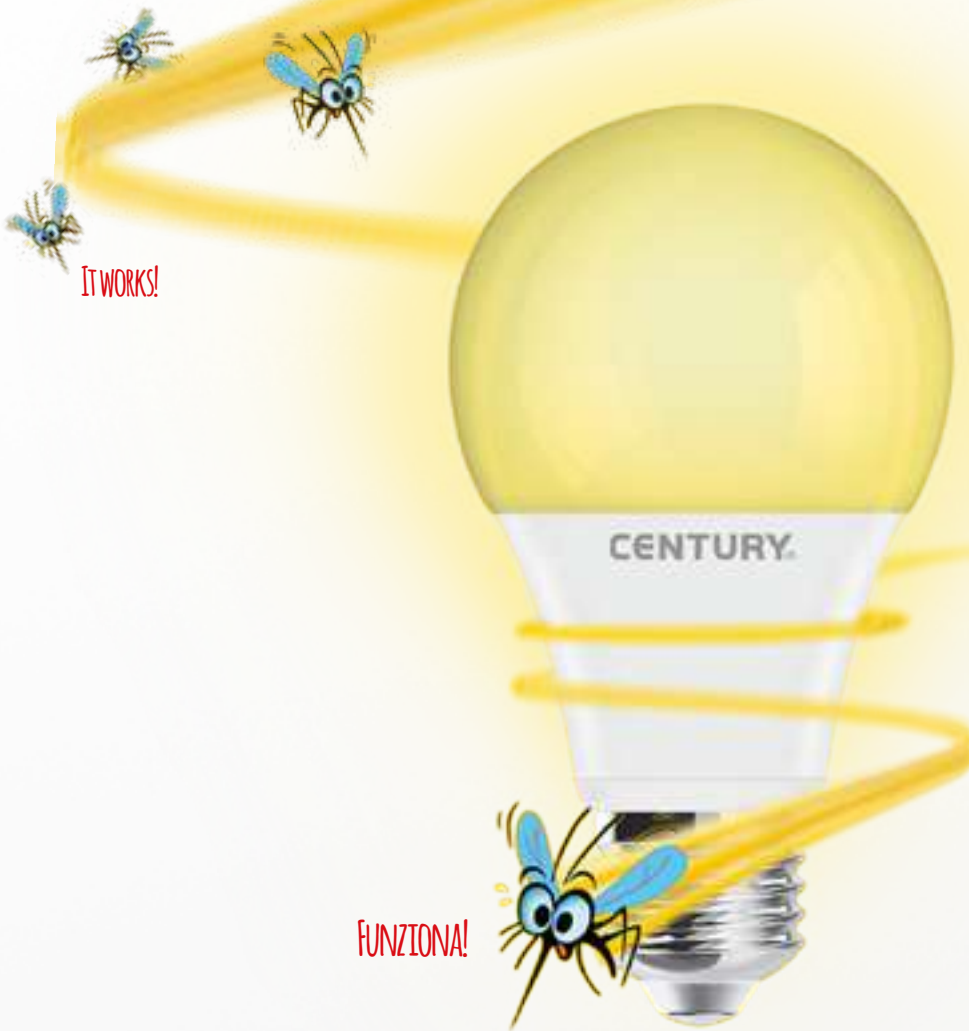

# KILLER 50 ANTIZANZARA LED

16

Protegge una superficie fino a 16 m<sup>2</sup>  
Surface protection up to 16 m<sup>2</sup>



Atossica  
Non-Toxic



Tiene lontane le zanzare  
Keep mosquitoes away



Inodore  
Odorless



Sicura per persone e animali  
Safe for people and animals



In vendita con espositore da **25 pz**  
**25 pcs** Display ready for sale

SORGENTI - SPECIALI

# KILLER 50

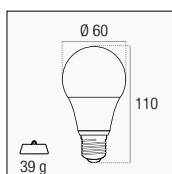

E27	9 W	= 50 W	650 lm	230° ∠	2200K	KLRSC-092700	1/25	€ 10,00
-----	-----	--------	--------	--------	-------	--------------	------	---------



Lampada dal particolare colore giallo che, filtrando i raggi infrarossi UV, crea una lunghezza d'onda (590 nm) capace di mantenere lontane le zanzare.

Special yellow lamp able to keep mosquitos away through a wave lenght (590 nm) created by UV rays filtering.



In vendita con espositore da 25 pz  
25 pcs Display ready for sale



CENTURY

SORGENTI

# SPECIALI

## Special



Ø18 x 50  
10 g



### LAMPADA FRIGO / FRIDGE LAMP

E14	1,8 W	= 15 W	130 lm	300° ∠	Blister	2700K	<b>FGF-011427</b>	12/48	€ 4,30
						5000K	<b>FGF-011450</b>		



Lampada dalle dimensioni estremamente ridotte adatta per uso specifico nel pieno rispetto dell'ambiente.  
Special eco-friendly short-sized lamp suitable for specific use.



Ø25 x 70  
14 g



### CANDELA VOTIVA

E14	0,4 W	25 lm	360° ∠	Color box	2700K	<b>VTV-052427</b>	50/200	€ 2,40
-----	-------	-------	--------	-----------	-------	-------------------	--------	--------

Lampada dalla luce soffusa adatta a creare ambientazioni evocative.  
Soft light lamp suitable for evocative ambiances.



**12 W** Ø180 x 25  
110 g

**18 W** Ø218 x 25  
160 g

**23 W** Ø253 x 25  
180 g



### CIRCOLINA

-	12 W	1.250 lm	120° ∠	Color box	3000K	<b>CRL-1218030</b>	1/20	€ 16,00
					4000K	<b>CRL-1218040</b>		
-	18 W	1.900 lm	120° ∠	Color box	3000K	<b>CRL-1821830</b>	1/20	€ 19,00
					4000K	<b>CRL-1821840</b>		
-	23 W	2.450 lm	120° ∠	Color box	3000K	<b>CRL-2425330</b>	1/20	€ 23,00
					4000K	<b>CRL-2425340</b>		

Rapida installazione con magneti  
Quick installation with magnets



Doppio sistema di montaggio: fissaggio con magneti nelle plafoniere già esistenti o fissaggio classico tramite viti.  
Double mounting system: magnet fixing installation for existing ceiling lights or classic screw fixing.

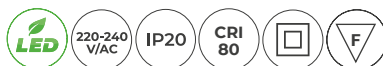



SORGENTI - SPECIALI

# FLAME

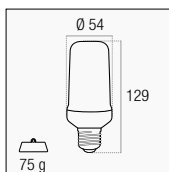

E27	4 W	140 lm	220° ∠	1500K	<b>FS1-042715</b>	6/24	€ 19,00
-----	-----	--------	--------	-------	-------------------	------	---------

### 3 modalità luminose / 3 light modes



Effetto fiamma  
Flame effect



Luce fissa  
Always on



Dissolvenza  
Fade



Guardala in azione  
See it in action



Giroscopio / Gyroscope  
La fiamma seguirà sempre la direzione corretta  
The flame will always follow the correct direction

Niente batte il calore e la spettacolarità del fuoco. Ogni chip è programmato singolarmente per dare vita alla fiamma.

Nothing compare the amazing view of the fire. Each chip is individually programmed to bring flame to life.



SORGENTI  
SORGENTI  
**SORGENTI**  
SORGENTI  
SORGENTI

PROFESSIONALI  
PROFESSIONALI  
**PROFESSIONALI**  
PROFESSIONALI  
PROFESSIONALI

PROFESSIONAL SOURCES  
PROFESSIONAL SOURCES  
**PROFESSIONAL SOURCES**  
PROFESSIONAL SOURCES

# LOTUS

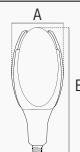

			
	A mm	B mm	g
30 W	Ø96	228	274
50 W	Ø108	264	330
E40	Ø108	274	405

E27	30 W	2.800 lm	330° ∠	1800K	LTS-302718	1/20	€ 33,00
		3.200 lm	330° ∠	3000K	LTS-302730	1/20	€ 30,00
				4000K	LTS-302740		
	50 W	4.250 lm	330° ∠	1800K	LTS-502718	1/20	€ 46,00
		5.400 lm	330° ∠	2200K	LTS-502722		
				3000K	LTS-502730		
E40	50 W	4.750 lm	330° ∠	2200K	LTS-504022	1/20	€ 46,00
		5.400 lm	330° ∠	3000K	LTS-504030		
				4000K	LTS-504040		



Lampada ad alta potenza di forma simile alle tradizionali SAP, capace di garantire una luce morbida e uniforme. Ottima dissipazione e idonea all'uso prolungato.

High-power lamp with SAP traditional shape, for a soft and uniform light. Excellent dissipation suitable for prolonged use.







● **Angolo luce di 360°**  
Sul piano orizzontale ed elevata resa luminosa

**360 ° light beam**  
On horizontal axis and high light output

CENTURY

● **Ideale per ambienti esterni  
in apparecchi IP65**

C grazie alla struttura in alluminio alettato riesce a dissipare il calore anche in condizioni estreme.

● **Ideal for outdoor  
in IP65 luminaires**

Special finned aluminum structure designed for extreme conditions heating dissipation.

**PLOSE  
360**

**NEW**

SORGENTI - PROFESSIONALI

# PLOSE 360



Ideale per apparecchi chiusi  
Ideal for closed fixtures

Corpo in alluminio ad alta dissipazione  
High dissipation aluminum body

	A mm	B mm	g
30 W	Ø73	175	430
40 W	Ø73	180	450
E40	Ø73	195	460

E27	30 W	4.300 lm	280° ∆	3000K	<b>PSE-302730</b>	5/20  € 60,00
				4000K	<b>PSE-302740</b>	
				6500K	<b>PSE-302765</b>	
E27	37 W	5.700 lm	280° ∆	3000K	<b>PSE-402730</b>	5/20  € 82,00
				4000K	<b>PSE-402740</b>	
				6500K	<b>PSE-402765</b>	
E40	40 W	5.700 lm	280° ∆	3000K	<b>PSE-404030 NEW</b>	5/20  € 86,50
				4000K	<b>PSE-404040 NEW</b>	
				6500K	<b>PSE-404065 NEW</b>	



Angolo luce di 360° orizzontale e 280° verticale  
360° horizontal and 280° vertical light beam

Applicabile in apparecchi con grado di protezione IP65, angolo luce di 360° su piano orizzontale ed elevata resa luminosa.

Suitable for IP65 fixtures, 360° light beam angle on horizontal axis and high light output.

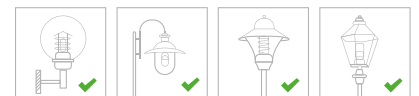

Ideale per ambienti esterni in apparecchi IP65  
Ideal for outdoor environments in IP65 luminaires



MAXIMA  
MAXIMA  
**MAXIMA**  
MAXIMA  
MAXIMA



MAXIMA



MAXIMA Round

# MAXIMA - MAXIMA Round

MAXIMA

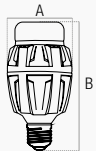

	A mm	B mm	g
40 W	Ø 78	151	265
70 W	Ø 88	180	396
100 W	Ø 98	198	511
150 W	Ø114	230	748

E27	40 W	4.300 lm	175-250 V/AC 50/60 Hz	200° ∠	4000K	<b>MX-402740</b>	5/20	€ 70,00
E40	70 W	7.600 lm	175-250 V/AC 50/60 Hz	200° ∠	4000K	<b>MX-704040</b>	5/10	€ 108,00
				200° ∠	6500K	<b>MX-704065</b>		
	100 W	10.950 lm	175-250 V/AC 50/60 Hz	200° ∠	4000K	<b>MX-1004040</b>	5/10	€ 122,00
				200° ∠	6500K	<b>MX-1004065</b>		
150 W	16.490 lm	175-250 V/AC 50/60 Hz	270° ∠	4000K	<b>MX-1504040</b>	5/10	€ 182,00	
			270° ∠	6500K	<b>MX-1504065</b>			



MAXIMA Round



	A mm	B mm	g
50 W	Ø145	215	470
100 W	Ø190	268	855

E27	50 W	4.000 lm	170-240 V/AC 50/60 Hz	180° ∠	4000K	<b>MXR-502740</b>	5/10	€ 41,00
E40	50 W	4.000 lm	170-240 V/AC 50/60 Hz	180° ∠	4000K	<b>MXR-504040</b>		
		4.100 lm	170-240 V/AC 50/60 Hz	180° ∠	6500K	<b>MXR-504065</b>		
	100 W	8.000 lm	170-240 V/AC 50/60 Hz	180° ∠	4000K	<b>MXR-1004040</b>	5/10	€ 72,00



Corpo in alluminio pressofuso verniciato a polveri epossidiche. Idonea per sospensioni industriali aperte ma non adatta ad ambienti altamente polverosi.

Die-cast aluminum body painted with epoxy powders. Suitable for open industrial suspensions but not suitable for very dusty environments.

Ventola di raffreddamento ad inibizione brushless  
Cooling fan with brushless inhibition



Diffusore in PC opale  
Opal PC diffuser

Piastra LED multichip SMD 3528  
SMD 3528 multichip LED plate

Dissipatore in alluminio 1060  
1060 aluminum heatsink

Driver ad alta potenza  
High power driver

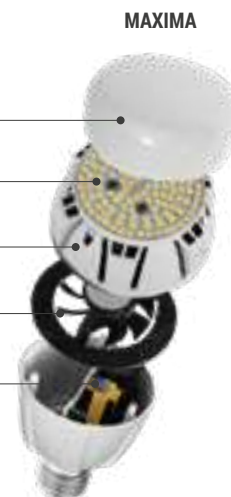



# SERIE LIGHT



LR50 E14

LR63 E27

LR80 E27

	A mm	B mm	g
5 W	Ø 50	85	27
9 W	Ø 63	100	40
15 W	Ø 80	112	77

E14	5 W	= 40 W	470 lm	120° ∠	3000K	<b>LR50-051430</b>	6/24	€ 5,00
					4000K	<b>LR50-051440</b>		
E27	9 W	= 60 W	820 lm	120° ∠	3000K	<b>LR63-082730</b>	6/24	€ 6,70
					4000K	<b>LR63-082740</b>		
	15 W	= 100 W	1.521 lm	150° ∠	3000K	<b>LR80-152730</b>	6/24	€ 9,00
					4000K	<b>LR80-152740</b>		

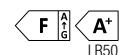

Lampade LED direzionali che generano un fascio mirato di luce, disponibili in diverse temperature di colore luce.

Directional LED lamps for a focused light, available in different light color temperatures.



# SERIE LIGHT



PAR20

PAR30

PAR38

	A	B	g
	mm	mm	g
8 W	Ø63	89	54
10 W	Ø95	105	96
15 W	Ø121	131	125

E27	8 W	= 60 W	640 lm	40° ∠	3000K	<b>PAR20-082730</b>	6/24	€ 7,00
					4000K	<b>PAR20-082740</b>		
	10 W	= 75 W	730 lm	38° ∠	3000K	<b>PAR30-102730</b>	6/24	€ 12,00
					4000K	<b>PAR30-102740</b>		
	15 W	= 100 W	1.100 lm	38° ∠	3000K	<b>PAR38-152730</b>	6/24	€ 16,00
					4000K	<b>PAR38-152740</b>		

Speciale lente per omogeneità del fascio luminoso  
Special lens for uniformity light beam



Lampade PAR di nuova generazione con speciale fascio di luce, soluzione ideale per l'illuminazione spot.

New generation PAR lamps with special light beam angle, ideal solution for spot lighting.





# PAR SHOP



SHPAR20

SHPAR38

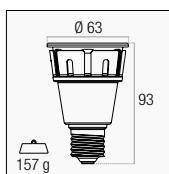

E27	8 W = 75 W	640 lm	38° ∠	3000K	<b>SHPAR20-082730</b>	6/24	€ 40,00
		656 lm	38° ∠	4000K	<b>SHPAR20-082740</b>		

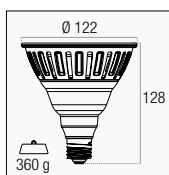

E27	18 W = 120 W	1.430 lm	38° ∠	3000K	<b>SHPAR38-182730</b>	6/24	€ 74,00
		1.462 lm	38° ∠	4000K	<b>SHPAR38-182740</b>		



Lampade PAR di nuova generazione con speciale fascio di luce, soluzione ideale per l'illuminazione spot.

New generation PAR lamps with special light beam angle, ideal solution for spot lighting.



Dimmerabile con sistemi Trailing-Edge  
Dimmable with Trailing-Edge systems

# PAR56

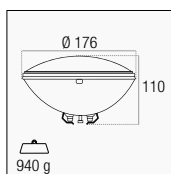

-	30 W	= 300 W	2.700 lm	90° ∠	4000K	<b>PAR56-301640</b>	6/24	€ 166,00
					6000K	<b>PAR56-301660</b>		

Lampada per piscine in vetro temperato anti invecchiamento  
Anti-aging tempered glass pool lamp



Si installa con semplicità. Realizzata in vetro, ha un indice di protezione IP68 che la rende perfettamente resistente alle immersioni prolungate.

Easy installation. Made of glass, IP68 protection index resistant to prolonged immersions.

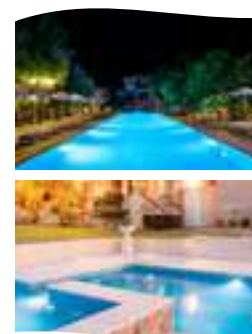

Ideali per illuminare le piscine  
Ideal for swimming pools lighting



# PL-COVER



E27



G24d

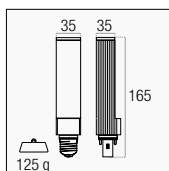

E27	10 W	= 18 W	800 lm	120° ∠	4000K	PLC-102740	6/24	€ 21,00
G24d	10 W	= 18 W	800 lm	120° ∠	4000K	PLC-102440		



Diffusore in PC opale.  
Si raccomanda, prima dell'installazione,  
di rimuovere ogni alimentatore elettronico  
ed elettromagnetico presente nel corpo  
illuminante.

Opal PC diffuser.  
Before installation, remove any electronic and  
electromagnetic ballast in the lighting body.



UP

SORGENTI - PROFESSIONALI

# GXLED

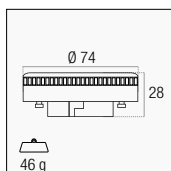

GX53	5 W	= 40 W	470 lm	120° ∠	3000K	<b>GXLED-055330 UPGRADE</b>	6/24	€ 16,00
			470 lm	120° ∠	4000K	<b>GXLED-055340 UPGRADE</b>		

New design  
Better performance



Dissipatore in plastica e diffusore in PC opale.

Plastic heatsink and opal PC diffuser.



CENTURY®

**NEW**

SORGENTI - PROFESSIONALI

# CITY LAMP AR111



GU10

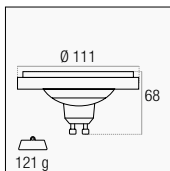
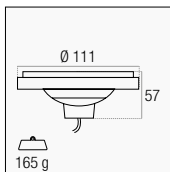

-	15 W	= 100 W	1100 lm	24° $\angle$	3000K	<b>CL-152430</b>	6/24	€ 19,00
					4000K	<b>CL-152440</b>		

Driver esterno incluso  
External Driver included



**COB GU10**

GU10	15 W	= 100 W	1.100 lm	38° $\angle$	3000K	<b>CLGU10-153830 NEW</b>	6/24	€ 15,00
					4000K	<b>CLGU10-153840 NEW</b>		



Brillante effetto visivo, riproduce in modo fedele i reali colori risaltando la bellezza degli oggetti.

Brilliant visual effect, the lamp assures real colors of objects highlighting their beauty.



SORGENTI - PROFESSIONALI

# SUPERLED AR111

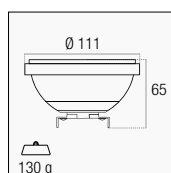

G53	12 W	= 50 W	900 lm	38° ∠	3000K	<b>SLAR111-124030</b>	10/50	€ 16,00
					4000K	<b>SLAR111-124040</b>		

Alimentazione con trasformatori elettromagnetici  
Power supply with electromagnetic transformers



Brillante effetto visivo, riproduce in modo fedele i reali colori risaltando la bellezza degli oggetti.

Brilliant visual effect, the lamp assures real colors of objects highlighting their beauty.



**CENTURY**



SORGENTI

# TUBI LED



# FULL VISION

BOX

	A mm	g
9 W	600	110
10 W	600	110
14 W	900	158
18 W	1200	211
22 W	1500	259

G13	10 W	1.100 lm	270° Δ	4000K	<b>FVT8-096040</b>	1/25	€ 6,00
				6500K	<b>FVT8-096065</b>		
	14 W	1.400 lm	270° Δ	4000K	<b>FVT8-149040</b>	1/25	€ 11,00
				6500K	<b>FVT8-149065</b>		
	18 W	2.000 lm	270° Δ	3000K	<b>FVT8-181230</b>	1/25	€ 9,00
				4000K	<b>FVT8-181240</b>		
				6500K	<b>FVT8-181265</b>		
				3000K	<b>FVT8-221530</b>		
	22 W	2.500 lm	270° Δ	4000K	<b>FVT8-221540</b>	1/25	€ 11,00
				6500K	<b>FVT8-221565</b>		
				6500K	<b>FVT8-221565</b>		



FVT8 - Box

Scatola da 25 pz con packaging in cartone  
Box of 25 pcs with cardboard packaging

INDUSTRIAL PACK

	A mm	g
9 W	600	110
18 W	1200	211
22 W	1500	259

G13	9 W	900 lm	270° Δ	4000K	<b>FVT8M-096040</b>	1/25	€ 5,00
				6500K	<b>FVT8M-096065</b>		
	18 W	2.000 lm	270° Δ	4000K	<b>FVT8M-181240</b>	1/25	€ 8,00
				6500K	<b>FVT8M-181265</b>		
	22 W	2.500 lm	270° Δ	4000K	<b>FVT8M-221540</b>	1/25	€ 9,00
				6500K	<b>FVT8M-221565</b>		



FVT8M - Industrial Pack

Confezione industriale da 25 pz con foam protettivo  
Industrial pack of 25 pcs with protective foam

Idoneo per plafoniere con parabola riflettente.  
Struttura in vetro opale per un fascio luminoso omogeneo.

Suitable for ceiling lights with reflector.  
Opal glass structure for a uniform light beam angle.





GO GO SMART SMART  
GO GO SMART SMART  
**GO GO SMART SMART**  
GO GO SMART SMART  
GO GO SMART SMART





*La domotica senza costi!*  
*Domotic without costs!*

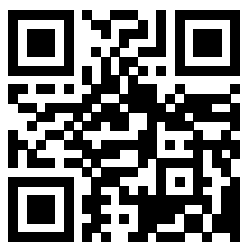

Guarda il video dimostrativo  
Watch the demonstrative video







### Milioni di colori

Il colore è emozione, energia, stato d'animo. Crea la **giusta atmosfera** per ogni occasione grazie alle **infinite possibilità di scelta**.

#### Millions of colors

Color is emotion, energy, mood. Create the **right atmosphere** for any occasion thanks to the **endless possibilities of choice**.



### Controllo vocale

Puoi usare la **tua voce** per chiedere agli **assistenti virtuali** Alexa o Google Assistant di accendere la luce, regolare il colore e la luminosità.

#### Voice control

You can use your voice to ask **virtual assistants** Alexa or Google Assistant to turn on the light, adjust its color and brightness.



### Bianco puro, alta luminosità

Quando c'è bisogno di luce **scegli il bianco**. Imposta un bianco freddo per leggere o studiare e un bianco caldo per le attività meno impegnative.

#### Pure white, high brightness

When there is a need for light, **choose white**. Set cool white when reading or studying and warm white for less demanding activities.



### Crea i tuoi gruppi

Raggruppa i tuoi dispositivi GO SMART per un **controllo sincronizzato**. Tutta la luce della tua casa sarà nel palmo di una mano!

#### Create your groups

Group your GO SMART devices together for **synchronized control**. All the light in your home will be in the palm of your hand!



### Dimmerabile

Regola la luminosità in base alle tue esigenze: la casa è un luogo dinamico e la luce sa adattarsi benissimo.

#### Dimmable

Adjust the **brightness** according to your needs: your home is a dynamic place and the light adapts perfectly.



### Ovunque sei

Puoi **controllare e regolare** la luce sia **in casa che fuori**. Non è necessario alcun dispositivo di rete aggiuntivo basta solo uno smartphone.

#### Wherever you are

You can **control and adjust** your light both **indoors and out**. It is not needed no hub are enough just a smartphone.



### Timer ON / OFF

Adatta la luce alla tua routine. Puoi **programmare l'accensione** insieme alla sveglia oppure lo **spegnimento notturno** nella stanza dei bambini.

#### Timer ON / OFF

Adapt your light to your routine. You can program it to **switch on** together with your alarm clock or **switch it off at night** in the children's room.







Powered by



### 1. Scarica e installa l'App

Cerca l'App "Tuya Smart" su Apple Store o Google Play Store per scaricare ed installare l'applicazione.



### 1. Download App

Search for "Tuya Smart" App on Apple Store or Google Play Store to download and install the application.



### 2. Registrati ed esegui il login

Apri l'app Tuya e registrati attraverso il tuo numero di telefono o tramite email. Una volta effettuato l'accesso procedi alla creazione di una nuova Casa.



### 2. Register and log in

Open Tuya app and register with your phone number or by email. Proceed to create a new Home.

### 3. Aggiungi il dispositivo

Per aggiungere un dispositivo, assicurarsi che sia nello stato di connessione (la lampada lampeggia velocemente). A questo punto la lampada inizia a lampeggiare ed è pronta per la connessione.

Cliccare su "+" in alto a destra nella sezione "La mia casa" di Tuya Smart e scegli "Fonte di Luce (Wi-Fi)" dal menù "Illuminazione", inserisci la password del Wi-Fi quindi per completare attendi il collegamento.



### 3. Add the device

To add a device, make sure it is in the connected state (the lamp blinks fast). At this point the lamp starts flashing and is ready for connection.

Click on "+" at the top right of the "My home" section of Tuya Smart and choose "Light source (Wi-Fi)" from the "Lighting" menu, enter the Wi-Fi password and then wait for the connection to complete.

### 4. Controlla il dispositivo

Una volta che il dispositivo è stato configurato con successo, il suo nome comparirà in lista nella schermata "La mia casa".

Premi su di esso per entrare nella schermata di controllo e premi al centro per accenderlo.

Divertiti a scoprire tutte le modalità della lampadina Smart.

Scegli una luce ideale per leggere, una per rilassarti oppure scopri le modalità per selezionare il colore della luce.

Pianifica l'accensione affinché la lampadina si accenda quando non sei in casa, oppure per svegliarti al mattino.

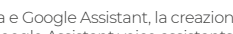

### 4. Control the device

Once the device has been successfully configured, its name will appear in the list on the screen "My home".

Press on it to enter its control screen and press the center to turn it on.

Have fun discovering all modes of Smart bulb.

Choose between an ideal light for reading, one for relaxing or discover the rotating modes of the light color. Schedule the ignition so that the light bulb turns on when you are not at home or to wake up in the morning.

Per l'integrazione con gli assistenti vocali Amazon Alexa e Google Assistant, la creazione di scenari o la condivisione di un dispositivo consultare il manuale di istruzioni del prodotto.  
For integration with Amazon Alexa and Google Assistant voice assistants, creating scenarios or sharing a device, consult the product instruction manual.



Ø65 x 134  
60 g



### GOCIA RGB+CCT

E27	14 W	= 100 W	1.400 lm	220° ∠	Blister	RGB + CCT 3000K - 6500K	<b>G3SMA-142700</b>	10/50	€ 21,00
-----	------	---------	----------	--------	---------	-------------------------	---------------------	-------	---------



Ø60 x 105  
55 g



### GOCIA CCT

E27	7 W	= 60 W	806 lm	220° ∠	Blister	CCT 2700K - 6500K	<b>ING3SMA-072700</b>	10/50	€ 17,00
-----	-----	--------	--------	--------	---------	-------------------	-----------------------	-------	---------



Ø47 x 88  
24 g



### SFERA

E14	6 W	= 40 W	470 lm	180° ∠	Blister	RGB + CCT 3000K - 6500K	<b>H1GSMA-061400</b>	10/50	€ 16,00
-----	-----	--------	--------	--------	---------	-------------------------	----------------------	-------	---------



Ø37 x 106  
25 g



### OLIVA

E14	6 W	= 40 W	470 lm	220° ∠	Blister	RGB + CCT 2700K - 6500K	<b>M1SMA-061400</b>	10/50	€ 16,00
-----	-----	--------	--------	--------	---------	-------------------------	---------------------	-------	---------



Ø50 x 56  
27 g



### SPOT

GU10	6 W	= 40 W	400 lm	120° ∠	Blister	RGB + CCT 2700K - 6500K	<b>GUSMA120-061000</b>	10/50	€ 16,00
			345 lm	38° ∠	Blister	RGB + CCT 2700K - 6500K	<b>GUSMA38-061000</b>		

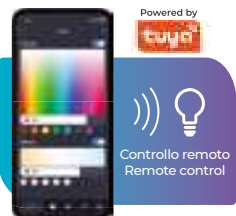

Powered by

Controllo remoto  
Remote control



Timer ON / OFF



Controllo funzioni di gruppo  
Group function control



Regolazione dei colori e del bianco  
Adjusting colors and white



Regolazione della luminosità  
Brightness adjustment

Puoi controllarle con la tua voce!  
You can control them with your voice!



Guarda il video dimostrativo  
Watch the demonstrative video

GO SMART

# ACCÈNTO SMART

## Strip RGB+W



# WiFi

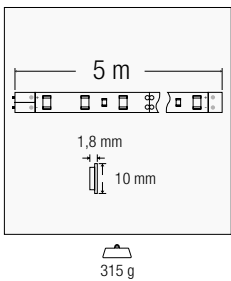

BIANCO / WHITE							
24 W (4,8 W/m)	1.650 lm (330 lm/m)	48 led/m	Blister	RGB+4000K	<b>ACRSM-484800</b>	10/20	€ 77,00

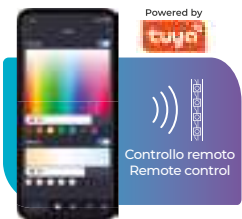

- Timer ON / OFF
- Controllo funzioni di gruppo  
Group function control
- Regolazione dei colori e del bianco  
Adjusting colors and white
- Regolazione della luminosità  
Brightness adjustment

Puoi controllarla con la tua voce!  
You can control it with your voice!



KIT pronto all'uso  
Ready-to-use KIT

GO SMART

# ACCÈNTO SMART

## Controller RGB+W



# WiFi

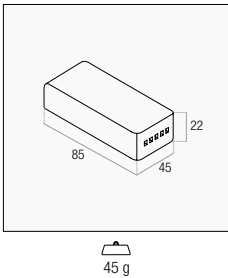

IN / OUT	CARICO MASSIMO / MAX LOAD				
12-24 V/DC	5 A x 4 Channel = 20 A / Max 120 W	Wi-Fi 2,4 GHz	<b>CTLSMA-ACRGBW</b>	10/20	€ 37,00

Rende Smart le strip LED RGB+W tradizionali.  
Makes traditional RGB+W strips Smart.

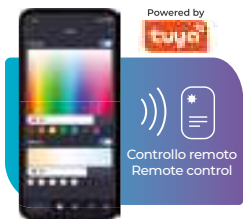

- Timer ON / OFF
- Controllo funzioni di gruppo  
Group function control
- Regolazione dei colori e del bianco  
Adjusting colors and white
- Regolazione della luminosità  
Brightness adjustment

Puoi controllarlo con la tua voce!  
You can control it with your voice!



IP20



Compatibile con  
Compatible with  
**ACRGBW-196010**



**CENTURY**

GO SMART

GO SMART

# BLANCA SMART

WiFi



CCT  
3000K-6500K

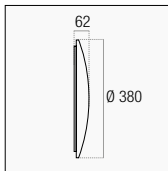

700 g

24 W	1.800 lm	120° $\triangle$	CCT 3000K - 6500K	BCSMA-243800	1/10	€ 67,00
------	----------	------------------	-------------------	--------------	------	---------

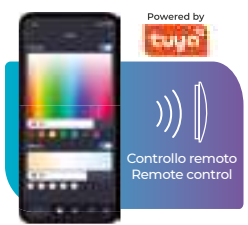

- Timer ON / OFF
- Controllo funzioni di gruppo  
Group function control
- Regolazione dei colori e del bianco  
Adjusting colors and white
- Regolazione della luminosità  
Brightness adjustment
- Nessun hub richiesto  
No hub required

Puoi controllarla con la tua voce!  
You can control it with your voice!

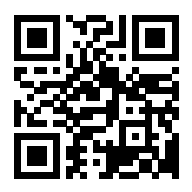

Guarda il video dimostrativo  
Watch the demonstrative video



# SPOTFIVE SMART



RGB + CCT

CCT

CCT  
3000K-6500K

RGB + CCT

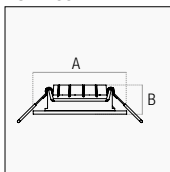

	A	B	Beam	Weight	Beam angle	Color	Model	Life span	Price
12 W	750 lm	Ø 150 mm	46 mm	Ø 125 mm	200 g	120°	RGB + CCT 2700K - 6500K	10/20	€ 62,00
18 W	1.170 lm	Ø 176 mm	55 mm	Ø 150 mm	356 g	120°	RGB + CCT 3000K - 6500K	10/20	€ 86,00



CCT

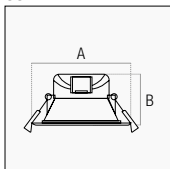

	A	B	Beam	Weight	Beam angle	Color	Model	Life span	Price
18 W	1.800 lm	Ø 190 mm	80 mm	Ø 150 mm	310 g	100°	CCT 3000K - 6500K	10/20	€ 58,00
24 W	2.400 lm	Ø 190 mm	80 mm	Ø 150 mm	310 g	100°	CCT 3000K - 6500K	10/20	€ 60,00

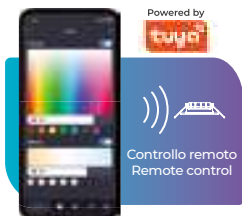

- Timer ON / OFF
- Controllo funzioni di gruppo  
Group function control
- Regolazione dei colori e del bianco  
Adjusting colors and white
- Regolazione della luminosità  
Brightness adjustment
- Nessun hub richiesto  
No hub required

Puoi controllarli con la tua voce!  
You can control them with your voice!



Guarda il video dimostrativo  
Watch the demonstrative video



# INTERRUTTORE SMART

WiFi



1 PULSANTE / BUTTON

2 PULSANTI / BUTTONS

3 PULSANTI / BUTTONS

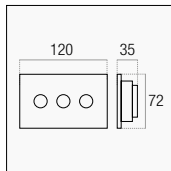

146 g

1 Pulsante Touch / 1 Touch Button	MAX 5 A	Wi-Fi 2,4 GHz IEEE 802.11 b/g/n	<b>SWSMA-1</b>	1/4	€ 50,00
2 Pulsanti Touch / 2 Touch Buttons	MAX 5 A	Wi-Fi 2,4 GHz IEEE 802.11 b/g/n	<b>SWSMA-2</b>	1/4	€ 58,00
3 Pulsanti Touch / 3 Touch Buttons	MAX 5 A	Wi-Fi 2,4 GHz IEEE 802.11 b/g/n	<b>SWSMA-3</b>	1/4	€ 62,00

Interruttori Smart controllabili da remoto.  
Smart WIFI switches with remote control



- Timer ON / OFF
- Controllo funzioni di gruppo  
Group function control
- Countdown
- Nessun hub richiesto  
No hub required

Puoi controllarli con la tua voce!  
You can control them with your voice!



Idonei per scatole 503  
Suitable for 503 boxes

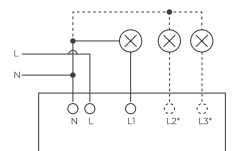

Schema di collegamento interruttore  
Switch connection diagram



# SMART POWER





PLUG

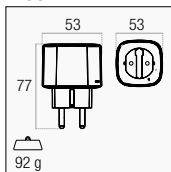

SWITCH

PLUG



Schuko (EU)	MAX 3.680 W	220-240 V/AC 50/60 Hz	MAX 16 A	<b>SCKSMA</b>	25/50 	€ 32,00
-------------	-------------	-----------------------	----------	---------------	---	---------

Presa intelligente con attacco Schuko  
Smart plug with Schuko socket



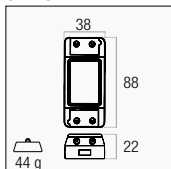

SWITCH

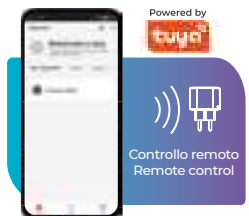

Cavo / Cable	MAX 2.200 W	90-250 V/AC 50/60 Hz	MAX 16 A	<b>CTLSMA</b>	9/90 	€ 24,00
--------------	-------------	----------------------	----------	---------------	--	---------

Interruttore intelligente con collegamento in cavo  
Smart switch with in-line connection



-  Timer ON / OFF
-  Controllo funzioni di gruppo  
Group function control
-  Countdown
-  Nessun hub richiesto  
No hub required

Puoi controllarli con la tua voce!  
You can control them with your voice!



Guarda il video dimostrativo  
Watch the demonstrative video





B L I S T E R  
B L I S T E R  
**B L I S T E R**  
B L I S T E R  
B L I S T E R



BLISTER - FILAMENTO

# INCANTO CLEAR

## Blister 2 pz



Ø45 x 80  
13 g



### SFERA E14

E14	2 W = 25 W	250 lm	330° ∠	2700K	<b>INH1G-021427BL2</b>	6/48	€ 7,00
				4000K	<b>INH1G-041440BL2</b>	6/48	€ 8,00
	4 W = 40 W	470 lm	330° ∠	2700K	<b>INH1G-041427BL2</b>	6/48	€ 8,00
				4000K	<b>INH1G-041440BL2</b>		
	6 W = 60 W	806 lm	330° ∠	2700K	<b>INH1G-061427BL2</b>	6/48	€ 10,00
				4000K	<b>INH1G-061440BL2</b>		



Ø45 x 80  
19 g



### SFERA E27

E27	2 W = 25 W	250 lm	330° ∠	2700K	<b>INH1G-022727BL2</b>	6/48	€ 7,00
				4000K	<b>INH1G-042740BL2</b>	6/48	€ 8,00
	4 W = 40 W	470 lm	330° ∠	2700K	<b>INH1G-042727BL2</b>	6/48	€ 8,00
				4000K	<b>INH1G-042740BL2</b>		
	6 W = 60 W	806 lm	330° ∠	2700K	<b>INH1G-062727BL2</b>	6/48	€ 10,00
				4000K	<b>INH1G-062740BL2</b>		



Ø35 x 98  
14 g



### CANDELA

E14	2 W = 25 W	250 lm	330° ∠	2700K	<b>INM1-021427BL2</b>	6/48	€ 7,00
				4000K	<b>INM1-041440BL2</b>	6/48	€ 8,00
	4 W = 40 W	470 lm	330° ∠	2700K	<b>INM1-041427BL2</b>	6/48	€ 8,00
				4000K	<b>INM1-041440BL2</b>		
	6 W = 60 W	806 lm	330° ∠	2700K	<b>INM1-061427BL2</b>	6/48	€ 10,00
				4000K	<b>INM1-061440BL2</b>		



Ø35 x 98  
14 g



### TORTIGLIONE

E14	4 W = 40 W	470 lm	330° ∠	2700K	<b>INTOR-041427BL2</b>	6/48	€ 8,00
-----	------------	--------	--------	-------	------------------------	------	--------



Lampade a filamento LED in vetro trasparente per un'illuminazione diffusa a 330°.

Transparent glass LED filament lamps with 330° diffused lighting.



**NEW**

BLISTER - FILAMENTO

# INCANTO CLEAR

## Blister 2 pz



Ø37 x 118  
14 g



### COLPO DI VENTO

E14	2 W	= 25 W	250 lm	330° ∠	2700K		<b>INM1C-021427BL2</b>	6/48	€ 7,00
	4 W	= 40 W	470 lm	330° ∠	2700K		<b>INM1C-041427BL2</b>	6/48	€ 8,00
					4000K		<b>INM1C-041440BL2</b>		



**4 W - E14** 025 x 85  
12 g

**7 W - E14** 030 x 102  
17 g

**9 W - E27** 030 x 98  
23 g



### TUBOLARE - 1 pz

E14	4 W	= 40 W	470 lm	330° ∠	2700K		<b>INTB-041427BL</b>	12/48	€ 4,00
	7 W	= 75 W	1.100 lm	330° ∠	2700K		<b>INTB-071427BL</b>	12/48	€ 5,00
E27	9 W	= 85 W	1.200 lm	330° ∠	2700K		<b>INTB-092727BL</b>	12/48	€ 7,50



Ø60 x 108  
33 g



### GOCCIA

E27	4 W	= 40 W	470 lm	330° ∠	2700K		<b>ING3-042727BL2</b>	6/48	€ 9,00
					4000K		<b>ING3-042740BL2</b>		
	7 W	= 60 W	806 lm	330° ∠	2700K		<b>ING3-082727BL2</b>	6/48	€ 10,00
					4000K		<b>ING3-082740BL2</b>		
	8 W	= 75 W	1.055 lm	330° ∠	2700K		<b>INSG3P-082727BL2</b>	6/48	€ 13,00
					4000K		<b>INSG3P-082740BL2</b>		
11 W	= 100 W	1.521 lm	330° ∠	2700K		<b>ING3-122727BL2 NEW</b>	6/48	€ 16,00	
				4000K		<b>ING3-122740BL2 NEW</b>			



Lampade a filamento LED in vetro trasparente per un'illuminazione diffusa a 330°.

Transparent glass LED filament lamps with 330° diffused lighting.





BLISTER - FILAMENTO

# INCANTO SATEN

## Blister 2 pz



### SFERA E14

E14	4 W = 40 W	470 lm	330° ∠	3000K	<b>INSH1G-041430BL2</b>	6/48	€ 8,00
				4000K	<b>INSH1G-041440BL2</b>		
				6500K	<b>INSH1G-041460BL2</b>		
	6 W = 60 W	806 lm	330° ∠	3000K	<b>INSH1G-061430BL2</b>	6/48	€ 10,00
				4000K	<b>INSH1G-061440BL2</b>		
				6500K	<b>INSH1G-061460BL2</b>		



### SFERA E27

E27	4 W = 40 W	470 lm	330° ∠	3000K	<b>INSH1G-042730BL2</b>	6/48	€ 8,00
				4000K	<b>INSH1G-042740BL2</b>		
				6500K	<b>INSH1G-042760BL2</b>		
	6 W = 60 W	806 lm	330° ∠	3000K	<b>INSH1G-062730BL2</b>	6/48	€ 10,00
				4000K	<b>INSH1G-062740BL2</b>		
				6500K	<b>INSH1G-062760BL2</b>		



### CANDELA

E14	4 W = 40 W	470 lm	330° ∠	3000K	<b>INSM1-041430BL2</b>	6/48	€ 8,00
				4000K	<b>INSM1-041440BL2</b>		
				6500K	<b>INSM1-041460BL2</b>		
	6 W = 60 W	806 lm	330° ∠	3000K	<b>INSM1-061430BL2</b>	6/48	€ 10,00
				4000K	<b>INSM1-061440BL2</b>		
				6500K	<b>INSM1-061460BL2</b>		



### TORTIGLIONE

E14	4 W = 40 W	470 lm	330° ∠	3000K	<b>INSTOR-041430BL2</b>	6/48	€ 8,00
				6500K	<b>INSTOR-041460BL2</b>		



Lampade a filamento LED in vetro opale per un'illuminazione morbida e diffusa.

Opal LED filament lamps with soft and diffused light.



**NEW**

BLISTER - FILAMENTO

# INCANTO SATEN

## Blister 2 pz



Ø37 x 118  
14 g



### COLPO DI VENTO

E14	4 W	= 40 W	470 lm	330° ∠	3000K <span style="color: yellow;">■</span>	<b>INSM1C-041430BL2</b>	6/48	€ 8,00
					6500K <span style="color: blue;">■</span>	<b>INSM1C-041460BL2</b>		

**E** A  
G



Ø60 x 108  
33 g



### GOCCIA

	7 W	= 60 W	806 lm	330° ∠	3000K <span style="color: yellow;">■</span>	<b>INSG3-082730BL2</b>	6/48	€ 10,00
					4000K <span style="color: green;">■</span>	<b>INSG3-082740BL2</b>		
					6500K <span style="color: blue;">■</span>	<b>INSG3-082760BL2</b>		
E27	8 W	= 75 W	1.055 lm	330° ∠	3000K <span style="color: yellow;">■</span>	<b>INSG3P-082730BL2</b>	6/48	€ 13,00
					4000K <span style="color: green;">■</span>	<b>INSG3P-082740BL2</b>		
					6500K <span style="color: blue;">■</span>	<b>INSG3P-082760BL2</b>		
	11 W	= 100 W	1.521 lm	330° ∠	3000K <span style="color: yellow;">■</span>	<b>INSG3-122730BL2 NEW</b>	6/48	€ 16,00
					4000K <span style="color: green;">■</span>	<b>INSG3-122740BL2 NEW</b>		
					6500K <span style="color: blue;">■</span>	<b>INSG3-122760BL2 NEW</b>		

**D** A  
G **E** A  
G  
11W

Lampade a filamento LED in vetro opale per un'illuminazione morbida e diffusa.

Opal LED filament lamps with soft and diffused light.



BLISTER - SPECIALI

# SENSOR



GOCCIA

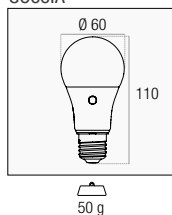

E27	11 W = 75 W	1.050 lm	200° ∠	Auto On-Off	3000K	<b>G3SP-102730BL</b>	6/24	€ 13,00
		1.150 lm	200° ∠	Auto On-Off	6400K	<b>G3SP-102764BL</b>		



On-Off automatico giorno-notte per un'illuminazione intelligente..

Automatic day-night On-Off for an intelligent lighting.



BLISTER - CLASSICHE





# ARIA PLUS

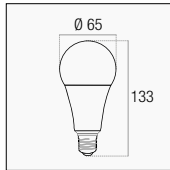

GOCCIA



83 g

E27	20 W	= 150 W	2.450 lm	180° ∠	3000K 	<b>ARP-202730BL</b>	6/24 	€ 8,50
					4000K 	<b>ARP-202740BL</b>		
					6500K 	<b>ARP-202765BL</b>		



Lampada moderna e versatile che garantisce massima qualità della luce.

Modern and versatile lamp that guarantees maximum light quality.



**CENTURY**

BLISTER - CLASSICHE

**ecoline**



GOCCIA

	A mm	B mm	g
6 W	Ø 60	108	30
9 W	Ø 60	108	30
112 W	Ø 60	110	30
15 W	Ø 60	123	40
17 W	Ø 65	133	83

E27	6 W = 40 W	490 lm	200° ∠	3000K	<b>ELG3-062730BL</b>	12/48	€ 3,00
				4000K	<b>ELG3-062740BL</b>		
				6500K	<b>ELG3-062764BL</b>		
	9 W = 60 W	820 lm	200° ∠	3000K	<b>ELG3-092730BL</b>	12/48	€ 3,50
				4000K	<b>ELG3-092740BL</b>		
				6500K	<b>ELG3-092764BL</b>		
	11 W = 75 W	1.050 lm	200° ∠	3000K	<b>ELG3-122730BL</b>	12/48	€ 4,00
				4000K	<b>ELG3-122740BL</b>		
				6500K	<b>ELG3-122764BL</b>		
15 W = 100 W	1.521 lm	200° ∠	3000K	<b>ELG3-152730BL</b>	12/48	€ 6,00	
			4000K	<b>ELG3-152740BL</b>			
			6500K	<b>ELG3-152764BL</b>			
18 W = 120 W	1.850 lm	180° ∠	3000K	<b>ELG3-172730BL</b>	12/48	€ 6,70	
			4000K	<b>ELG3-172740BL</b>			
			6500K	<b>ELG3-172764BL</b>			

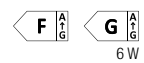

La miglior soluzione per una luce di qualità adatta a tutti gli ambienti.

The best solution for high quality light, suitable for any ambient.



BLISTER - CLASSICHE

# ecoline



3 W - 6 W 8 W  
 Ø45 x 80 Ø45 x 80  
 25 g 33 g



F 8 W G

### SFERA E14

E14	3 W = 25 W	250 lm	200° ∠	3000K	ELH1G-031430BL	12/48	€ 2,40
				4000K	ELH1G-031440BL		
				6500K	ELH1G-031464BL		
	6 W = 40 W	490 lm	200° ∠	3000K	ELH1G-061430BL	12/48	€ 2,60
				4000K	ELH1G-061440BL		
				6500K	ELH1G-061464BL		
8 W = 60 W	806 lm	180° ∠	3000K	ELH1G-081430BL	12/48	€ 3,50	
			4000K	ELH1G-081440BL			
			6500K	ELH1G-081465BL			



3 W - 6 W 8 W  
 Ø45 x 80 Ø45 x 80  
 25 g 33 g



F 8 W G

### SFERA E27

E27	3 W = 25 W	250 lm	200° ∠	3000K	ELH1G-032730BL	12/48	€ 2,40
				4000K	ELH1G-032740BL		
				6500K	ELH1G-032764BL		
	6 W = 40 W	490 lm	200° ∠	3000K	ELH1G-062730BL	12/48	€ 2,60
				4000K	ELH1G-062740BL		
				6500K	ELH1G-062764BL		
8 W = 60 W	806 lm	180° ∠	3000K	ELH1G-082730BL	12/48	€ 3,50	
			4000K	ELH1G-082740BL			
			6500K	ELH1G-082765BL			



3 W - 6 W 8 W  
 Ø37 x 106 Ø37 x 106  
 20 g 30 g



F 8 W G

### CANDELA

E14	3 W = 25 W	250 lm	220° ∠	3000K	ELM1-031430BL	12/48	€ 2,40
				4000K	ELM1-031440BL		
				6500K	ELM1-031464BL		
	6 W = 40 W	490 lm	220° ∠	3000K	ELM1-061430BL	12/48	€ 2,60
				4000K	ELM1-061440BL		
				6500K	ELM1-061464BL		
8 W = 60 W	806 lm	220° ∠	3000K	ELM1-081430BL	12/48	€ 3,50	
			4000K	ELM1-081440BL			
			6500K	ELM1-081465BL			



Ø37 x 123  
 26 g



G

### COLPO DI VENTO

E14	3 W = 25 W	250 lm	220° ∠	3000K	ELM1C-031430BL	12/48	€ 2,40
				6500K	ELM1C-031440BL		
	6 W = 40 W	490 lm	220° ∠	3000K	ELM1C-061430BL	12/48	€ 2,60
				4000K	ELM1C-061440BL		
				6500K	ELM1C-061464BL		

La miglior soluzione per una luce di qualità adatta a tutti gli ambienti.

The best solution for high quality light, suitable for any ambient.





BLISTER - SPOT

**ecoline**



Ø50 x 54  
30 g



GU10	6 W	= 50 W	490 lm	110° ∠	3000K	<b>ELK110-061030BL</b>	12/48	€ 3,50
		= 50 W	490 lm	110° ∠	4000K	<b>ELK110-061040BL</b>		
		= 50 W	490 lm	110° ∠	6500K	<b>ELK110-061064BL</b>		

**G**

La miglior soluzione per una luce di qualità adatta a tutti gli ambienti.

The best solution for high quality light, suitable for any ambient.



BLISTER - SPOT

# SPOT MAXILED



Ø35 x 38  
13 g



MR11	3 W	= 20 W	240 lm	30° ∠	3000K	<b>K12XLED-300430BL</b>	6/24	€ 10,00
					4000K	<b>K12XLED-300440BL</b>		

Alimentazione con trasformatori elettromagnetici e non elettronici.  
Power supply with electromagnetic and non-electronic transformers.

**F**

Lampada dalle dimensioni ridotte, ottima per l'illuminazione d'accento.

Small-sized lamp, excellent for accent lighting..



BLISTER - STRIP LED

# ACCÈNTO KIT

## Blister

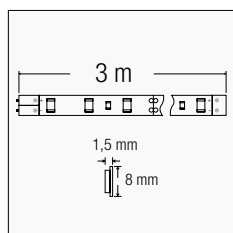

200 g

14,4 W (4,8 W/m)	1.260 lm (420 lm/m)	30 led/m	Blister	3000K	<b>ACBL-486030</b>	10/20	€ 35,00
				6000K	<b>ACBL-486060</b>		
	-	30 led/m	Blister	RGB	<b>ACRBL-486010</b>	10/20	€ 45,00

INTERNO / INDOOR



Il kit include / Kit includes

Strip LED da interno in kit pronto all'uso con alimentatore ed adesivo incluso per un rapido utilizzo.

Indoor LED strip in ready-to-use kit with strip and power supply for quick use.



Alimentatore a spina / Plug-in Power supply  
Telecomando IR / IR Remote (Solo / Only **ACRBL**)

BLISTER



CENTURY

367





VERSATILI  
VERSATILI  
**VERSATILI**  
VERSATILI  
VERSATILI

VERSATILE  
VERSATILE  
**VERSATILE**  
VERSATILE  
VERSATILE





## GIARDINETTO

La soluzione per coltivare le tue piante all'interno, in qualsiasi momento dell'anno.

Indoor solution for plants growing at any time of the year.

**Velocizza il ciclo di crescita rispetto alla luce naturale**  
Speeds up the growth cycle compared to natural light

**Ideale per fiori, erbe aromatiche ed ortaggi**  
Ideal for flowers, aromatic herbs and vegetables

**LED = bassi consumi energetici**  
LED = low energy consumption

**Facile da assemblare**  
Easy to assemble



**ON/OFF AUTOMATICO**  
simula il ciclo giorno/notte  
**AUTOMATIC ON/OFF**  
simulating the day / night cycle



**LUCE BIANCA NATURALE**  
simulazione ideale della luce solare  
**NATURAL WHITE LIGHT**  
ideal sunlight simulation



**PROCESSO DI FOTOSINTESI**  
accelera il ciclo di crescita **1573  $\mu\text{mol}/\text{J}$**   
**PHOTOSYNTHESIS PROCESS**  
accelerates growth phase **1573  $\mu\text{mol}/\text{J}$**





**NEW**

VERSATILI - ORTICULTURA

# GIARDINETTO

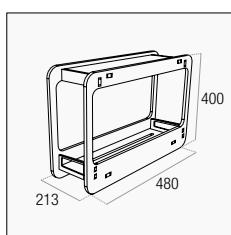

1900 g

14 W	Auto On-Off	4000K	<b>GRD-144840 NEW</b>	1/10	€ 69,00
------	-------------	-------	-----------------------	------	---------

Mini giardino LED per la coltivazione indoor di erbe aromatiche e piccoli ortaggi. On-Off automatico che simula il ciclo giorno-notte, 16 ore di accensione e 8 ore di spegnimento.

Mini LED garden for indoor cultivation of herbs and small vegetables. Automatic On-Off for day-night cycle, simulation 16 hours on and 8 hours off.



Stimola la fotosintesi delle piante  
Stimulates plant photosynthesis

**1.573  $\mu\text{mol}/\text{J}$**



**CENTURY**

371

VERSATILI



VERSATILI - PROIETTORI PORTATILI

# WORK



MINI WORK

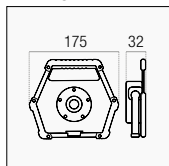

316 g

10 W	700 lm (100%) / 350 lm (50%)	90° ∠	6 x 1,5 V AAA	4000K	<b>MW-108040</b>	6/24	€ 26,00
------	------------------------------	-------	---------------	-------	------------------	------	---------

Struttura in ABS con rinforzi laterali in gomma  
ABS structure with rubber side reinforcements

Autonomia 100% (6 batterie) ~10 h / 50% (3 batterie) ~20 h  
Autonomy 100% (6 batteries) ~10 h / 50% (3 batteries) ~20 h



FUNNY

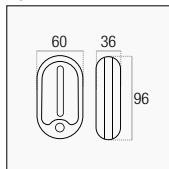

80 g

2 W	110 lm	110° ∠	3 x 1,5 V AAA	4000K	<b>FNY-020040</b>	12/48	€ 8,00
-----	--------	--------	---------------	-------	-------------------	-------	--------

Include gancio orientabile, doppio spot luce e magnete  
Swivel hook, double light spot and magnet included

Autonomia fino a ~10 h  
Autonomy up to ~10 h



PENNY

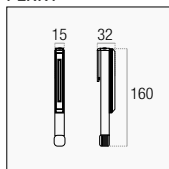

32 g

3 W	200 lm	120° ∠	3 x 1,5 V AAA	4000K	<b>PNY-030040</b>	12/48	€ 8,00
-----	--------	--------	---------------	-------	-------------------	-------	--------

Include gancio orientabile  
Swivel hook included

Autonomi fino a ~10 h  
Autonomy up to ~10 h



SALLY

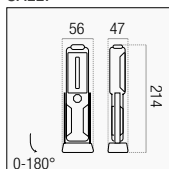

160 g

3 W	130 lm	120° ∠	3 x 1,5 V AAA	4000K	<b>SLY-030040</b>	12/48	€ 14,00
-----	--------	--------	---------------	-------	-------------------	-------	---------

Include gancio orientabile, doppio spot luce e doppio magnete  
Swivel hook, double light spot and double magnet included

Autonomia fino a ~10 h  
Autonomy up to ~10 h

E' possibile collocarli ovunque perché non necessitano di rete elettrica.  
Funzionano con batterie AAA (non incluse).

Placeable everywhere: no electrical network required. Workable with AAA batteries (not included).

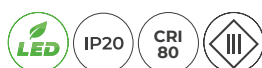

Distribuiti in blister in pratici display box  
Blister packs in practical display boxes

# BLISTER

## VERSATILI



MOUSE

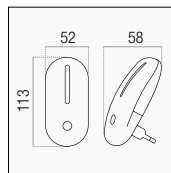

47 g

0,6 W	50 lm	120°	4000K	<b>MS-066040</b>	10/50	€ 6,00
-------	-------	------	-------	------------------	-------	--------

Accensione automatica notturna e spegnimento diurno  
Automatic night switch-on and daytime automatic switch-off



TOMMY

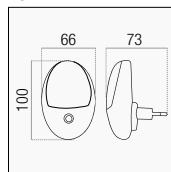

42 g

0,6 W	30 lm	120°	4000K	<b>TMY-062540</b>	10/50	€ 6,00
-------	-------	------	-------	-------------------	-------	--------

Accensione automatica notturna e spegnimento diurno  
Automatic night switch-on and daytime automatic switch-off



ITALO

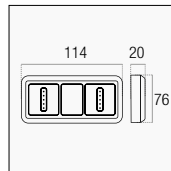

70 g

3 W	200 lm	120°	4 x 1,5 V AAA	4000K	<b>ITO-030040</b>	12/24	€ 7,50
-----	--------	------	---------------	-------	-------------------	-------	--------

Include adesivo 3M e magnete  
3M adhesive and magnet included.



NEMO

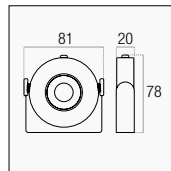

115 g

3 W	120 lm	120°	4 x 1,5 V AAA	4000K	<b>NE-030040</b>	12/24	€ 9,60
-----	--------	------	---------------	-------	------------------	-------	--------

Include magnete.  
Magnet included.



TERRY

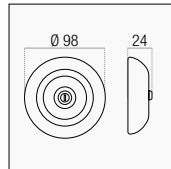

80 g

3 W	150 lm	120°	3 x 1,5 V AAA	4000K	<b>TRY-030040</b>	12/24	€ 7,50
-----	--------	------	---------------	-------	-------------------	-------	--------

Include adesivo 3M, magnete, viti per fissaggio a muro.  
3M adhesive, magnet and screws for wall mounting included



SOLIDEA

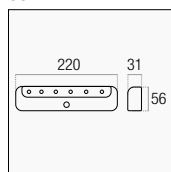

197 g

90°- 3 m

0,4 W	40 lm	120°	3 x 1,5 V AAA	4000K	<b>SLDS-042240</b>	6/24	€ 16,00
-------	-------	------	---------------	-------	--------------------	------	---------

Spegnimento automatico dopo 25 secondi.  
Automatic off after 25 seconds.

Selettore modalità  
Mode selector



Sensor  
OFF  
Always ON

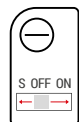

# VERSATILI COMODA



## EMERGENZA / EMERGENCY

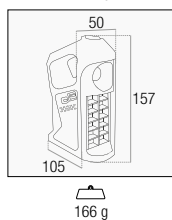

6 W	Li-Ion 3,7 V/DC 1.500 mAh*	6500K	<b>CMDEM-060065</b>	10/50	€ 16,00
-----	----------------------------	-------	---------------------	-------	---------

Ricarica ~3 h / Autonomia fino a ~4-6 h  
Recharge ~3 h / Autonomy up to ~4-6 h

**EMERG.**



Powerbank



Ricaricabile  
Rechargeable

\*1 anno di garanzia / 1 year warranty

## Doppia modalità luminosa / Double light mode

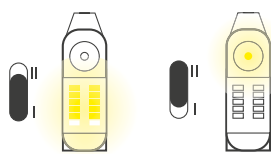

## Modalità emergenza / Emergency mode



Con interruttore impostato su I, mentre è in carica, la torcia resta spenta per poi accendersi in caso di blackout.

With the switch set to I, while it is charging, the flashlight remains off and then turns on in case of a blackout.



Pannello fotovoltaico  
Photovoltaic panel

## SOLAR

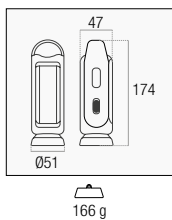

5 W	Lead 4 V/DC 1.000 mAh*	6500K	<b>CMDSOL-050065</b>	10/50	€ 13,00
-----	------------------------	-------	----------------------	-------	---------

Ricarica ~3 h (USB) / Autonomia fino a ~4-6 h  
Recharge ~3 h (USB) / Autonomy up to ~4-6 h



Ricaricabile  
Rechargeable

\*1 anno di garanzia / 1 year warranty

## Doppia modalità luminosa / Double light mode

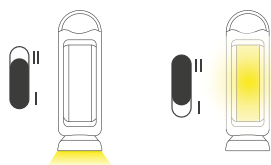

Mini torce LED portatili, ricaricabili con cavo micro USB (incluso). Corpo in materiale plastico antiurto.

Portable mini LED flashlight, rechargeable with micro USB cable (included). Shockproof plastic material body.



**NEW**

VERSATILI - SEGNALETICA

# SEGNALATORI

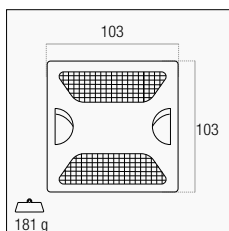
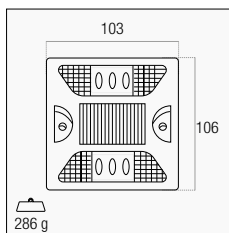
**BSS-024000****RFL100**

2,5 V / 0,2 W

Ni-MH 1,2 V / 800 mAh

Flash Mode

4000K

**BSS-024000 NEW**

6/24

€ 31,00

Autonomia fino a 100 h  
Autonomy up to 100 h

Catarifrangente / Reflector

Arancione / Orange ●

**RFL100 NEW**

6/24

€ 4,80

**BSS-024000**

Segnalatore stradale in alluminio, ricaricabile tramite il pannello fotovoltaico incluso.  
Autonomia fino a 100 ore.  
Fori per fissaggio a terra.

Aluminum road indicator, rechargeable via photovoltaic panel included.  
Autonomy up to 100 hours.  
Holes for ground fixing.

**RFL100**

Segnalatore catarifrangente in ABS.  
Finitura arancione per maggiore visibilità.  
Fondo sabbato per maggiore aderenza.

ABS Reflector.  
Orange finish for greater visibility.  
Sandblasted bottom for greater grip.



ES POSITORI  
**ES POSITORI**  
ES POSITORI

EXHIBITORS  
**EXHIBITORS**  
EXHIBITORS



NEW

ESPOSITORI

# MULTI SHOW

Che lo show

abbia inizio.



FIESTA

**KIT-EX-2RIP-FST NEW** 1/1



ARCADIA

**KIT-EX-2RIP-ARC NEW** 1/1



SHUTTLE SLIM

**KIT-EX-2RIP-SHS NEW** 1/1



PUSH & GO

**KIT-EX-2RIP-PHG NEW** 1/1



PL-QUADRO / PL-TONDO

**KIT-EX-2RIP-PQT NEW** 1/1



GIARDINETTO

**KIT-EX-2RIP-GRD NEW** 1/1

Espositori in legno forniti di prodotti campione già elettrificati pronti per essere collegati alla rete e mostrati in funzione.

Wooden exhibitors supplied with electrified sample products ready to be connected to the network and shown in operation.

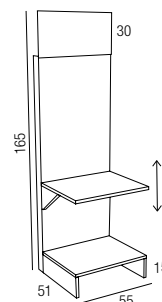



**NEW**

**ESPOSITORI**

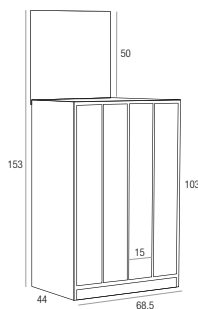

**EXPO LUME**

ESPOSITORE LUME PLUS / LUME PLUS EXHIBITOR

**EXPO-LUME NEW** 1/1

Espositore in legno fornito completo di prodotti e crowner pubblicitario in cartone.

Wooden exhibitors supplied with products and cardboard crowner.

**BANNER ESPOSITIVI / EXHIBITION BANNERS**



Size	Profile	Product Code	1/1
400 x 300 mm	Profile	<b>BAN40-PROFILI NEW</b>	
	Classic	<b>BAN100-CLAS</b>	
995 x 500 mm	Filamento Clear	<b>BAN100-FILCL</b>	
	Filamento Mix	<b>BAN100-FILMX</b>	
	Filamento Saten	<b>BAN100-FILST</b>	
	Strip LED	<b>BAN100-STRIP NEW</b>	
995 x 650 mm	Special	<b>BAN100-SPEC NEW</b>	
	Classic	<b>BAN133-CLAS</b>	
1230 x 500 mm	Filamento Clear	<b>BAN133-FILCL</b>	
	Filamento Mix	<b>BAN133-FILMX</b>	
	Filamento Saten	<b>BAN133-FILST</b>	

Banner espositivi in Forex, misure assortite  
Forex display banners, assorted sizes



CESTO PROMO DA TERRA / FLOOR PROMO BASKET

**EXPO-PROMO** 1/1

550 X 400 X 850 mm

Adatto per operazioni promozionali, fornito vuoto  
Suitable for promotional operations, products not included



**CROWNER EXPO PROMO**

Go Smart	<b>CRW-G3SMART</b>	1/1
Sensor	<b>CRW-G3SP</b>	
Killer 50	<b>CRW-KLR</b>	

540 x 700 mm

Pannello in cartone da associare con **EXPO-PROMO**  
Cardboard panel to be associated with **EXPO-PROMO**



**DISPLAY GO SMART**

**EXPO-GOSMART NEW** 1/1

700 X 470 X 300 mm

Display per prodotti GO SMART in cartone microonda  
Display for GO SMART products in microwave cardboard

## ESPOSITORI



ESPOSITORE PROVA LAMPADE / EXHIBITOR TEST LAMPS

2 x E27 - 2 x E14 - 1 x GU10	<b>BALUX5</b>	1/1
------------------------------	---------------	-----

440 X 140 X 220 mm



ESPOSITORE PROVA LAMPADE / EXHIBITOR TEST LAMPS

3 x E27 - 4 x E14 - 2 x GU10 - 3 x G9	<b>BALUX12</b>	1/1
---------------------------------------	----------------	-----

990 X 140 X 240 mm

Espositore professionale elettrificato con plexiglass di protezione. Interruttore a pressione, quando rilasciato la lampada si spegne.  
Professional electrified display with protective plexiglass. Push switch, when released the lamp turns off.



DISPLAY DA BANCO / COUNTER DISPLAY

<b>MAGIC BOX</b>	1/25
------------------	------

330 X 650 X 10 mm

Display in cartone capiente e facile da montare  
Large and easy to assemble cardboard display



DISPLAY DA TERRA / FLOOR DISPLAY

<b>EXPO-CEN1</b>	1/1
------------------	-----

457 X 400 X 1800 mm

Espositore con 20 ganci metallici, fornito vuoto  
Display with 20 metal hooks, products not included



ESPOSITORE PROVA LAMPADE / EXHIBITOR TEST LAMPS

<b>EXPOC-3VASCH</b>	1/1
---------------------	-----

600 X 400 X 1780 mm

Espositore modulare con 3 vasche innestabili  
Modular display with 3 plug-in bowls



ESPOSITORE PROFILI / PROFILES EXHIBITOR

<b>EXPO-PR</b>	1/1
----------------	-----

320 X 175 X 80 mm

Espositore con 19 profili campione  
Display with 19 sample profiles



PIASTRINA ESPOSITIVA / EXHIBITION PLATE

E14	<b>PIASTRINA P E14</b>	1/1
E27	<b>PIASTRINA P E27</b>	
	<b>PIASTRINA G E27</b>	

10 x 1 x 8 mm

Piastrina espositiva per lampade E14 o E27  
Exhibition plate for E14 or E27 lamps



FINE CORSA / END-OF-STROKE

<b>XT-FC</b>	1/200
--------------	-------

70 x 119 mm

Talloncino fustellato di fine corsa per ganci  
End-of-stroke punched-out for hooks

A  
B  
C  
D  
E  
F  
G  
H  
I  
J  
K  
L  
M  
N  
O  
P  
Q  
R  
S  
T  
U  
V  
W  
X  
Y  
Z

INDICE ALFABETICO  
INDICE ALFABETICO  
**INDICE ALFABETICO**  
INDICE ALFABETICO  
INDICE ALFABETICO

ALPHABETICAL INDEX  
ALPHABETICAL INDEX  
**ALPHABETICAL INDEX**  
ALPHABETICAL INDEX  
ALPHABETICAL INDEX

	COD.	INNER pz	MASTER pz	EAN	PAG.	€
<b>A</b>	AC2-142430	10	20	9020142430016	112	29,00
	AC2-142440	10	20	9090171009620	112	29,00
	AC2-142460	10	20	9020142460013	112	29,00
	AC2-722430	10	20	9090171000795	112	21,00
	AC2-722440	10	20	9090171009613	112	21,00
	AC2-722460	10	20	9090171000801	112	21,00
	AC20230-1512030	10	20	9090171019322	111	552,00
	AC20230-1512040	10	20	9090171019339	111	552,00
	AC5230-1512030	10	20	9090171019308	111	137,00
	AC5230-1512040	10	20	9090171019315	111	137,00
	AC90-146030	10	20	9090171009309	103	49,00
	AC90-146040	10	20	9090171009316	103	49,00
	AC90-146060	10	20	9090171009521	103	49,00
	AC90-2012030	10	20	9090171009323	103	74,00
	AC90-2012040	10	20	9090171009330	103	74,00
	AC90-2012060	10	20	9090171009347	103	74,00
	AC90-2030030	10	20	9090171009354	104	180,00
	AC90-2030040	10	20	9090171009538	104	180,00
	AC90-2030060	10	20	9090171009361	104	180,00
	AC90-2424030	10	20	9090171009378	103	139,00
	AC90-2424040	10	20	9090171009385	103	139,00
	AC90-2424060	10	20	9090171009392	103	139,00
	AC90-2442030	10	20	9090171009408	104	238,00
	AC90-2442040	10	20	9090171009415	104	238,00
	AC90-2442060	10	20	9090171009422	104	238,00
	AC90-3024030	10	20	9090171009439	105	146,00
	AC90-3024040	10	20	9090171009446	105	146,00
	AC90-3024060	10	20	9090171009453	105	146,00
	AC90-723030	10	20	9090171009491	103	34,00
	AC90-723040	10	20	9090171009507	103	34,00
	AC90-723060	10	20	9090171009514	103	34,00
	AC9067-146030	10	20	9090171009460	106	61,00
	AC9067-146040	10	20	9090171009477	106	61,00
	AC9067-146060	10	20	9090171009484	106	61,00
	ACBL-486030	10	20	9021486030108	367	35,00
	ACBL-486060	10	20	9021486060105	367	35,00
	ACBNRBI-AD	1	50	9090171018165	270	11,00
	ACBNRBI-CNEND	10	180	9090171012330	271	1,20
	ACBNRBI-CNFLEX	10	40	9090171012293	271	20,00
	ACBNRBI-CNINT	10	180	9090171012194	271	7,00
	ACBNRBI-CNL	20	80	9090171012231	271	14,00
	ACBNRBI-CNLIN	20	80	9090171012217	271	14,00
	ACBNRBI-CNLIVE	5	90	9090171012316	271	7,00
	ACBNRBI-CNLIVER	1	50	9090171018080	271	7,00
	ACBNRBI-CNR	1	25	9090171018066	271	14,00
	ACBNRBI-CNT	10	40	9090171012255	271	19,00
	ACBNRBI-CNTL1	1	25	9090171018141	271	20,00
	ACBNRBI-CNTL2	1	25	9090171018127	271	20,00
	ACBNRBI-CNTR	1	25	9090171018103	271	20,00
	ACBNRBI-CNX	10	40	9090171012279	271	24,00
	ACBNRBI-KIT	5	90	9090171012361	271	6,50
	ACBNRNE-AD	1	50	9090171018172	270	11,00
	ACBNRNE-CNEND	10	180	9090171012347	271	1,20
	ACBNRNE-CNFLEX	10	40	9090171012309	271	20,00
	ACBNRNE-CNINT	10	180	9090171012200	271	7,00
	ACBNRNE-CNL	20	80	9090171012248	271	14,00
	ACBNRNE-CNLIN	20	80	9090171012224	271	14,00
	ACBNRNE-CNLIVE	5	90	9090171012323	271	7,00
	ACBNRNE-CNLIVER	1	50	9090171018097	271	7,00
	ACBNRNE-CNR	1	25	9090171018073	271	14,00
	ACBNRNE-CNT	10	40	9090171012262	271	19,00
	ACBNRNE-CNTL1	1	25	9090171018158	271	20,00
	ACBNRNE-CNTL2	1	25	9090171018134	271	20,00
	ACBNRNE-CNTR	1	25	9090171018110	271	20,00
	ACBNRNE-CNX	10	40	9090171012286	271	24,00
	ACBNRNE-KIT	5	90	9090171012354	271	6,50
	ACCN10	1	100	9090171011869	114	1,80
	ACCN10ANG	1	100	9090171011890	114	3,60
	ACCN10T	1	100	9090171011906	114	4,80
	ACCN10WIRE	1	100	9090171011876	114	1,90
	ACCN10WIRE2	1	100	9090171011883	114	2,40
	ACCN10X	1	100	9090171011913	114	5,50
	ACCN8	1	100	9090171011807	114	1,20
	ACCN8ANG	1	100	9090171011838	114	3,10
	ACCN8T	1	100	9090171011845	114	4,00
	ACCN8WIRE	1	100	9090171011814	114	1,60
	ACCN8WIRE2	1	100	9090171011821	114	2,20
	ACCN8X	1	100	9090171011852	114	4,80
	ACRBL-486010	10	20	9021486010100	367	45,00
	ACRGBW-196010	10	20	9090171011364	109	96,00
	ACRGBW-956030	10	20	9090171017786	107	94,00
	ACRGBW-956040	10	20	9090171017793	107	94,00
	ACRSMA-484800	10	20	9090171012453	350	77,00
	ACSB-151240	6	24	9090171004571	195	25,00
	ACSB-321240	1	12	9090171005196	195	50,00
	ACSB-681240	1	8	9090171005202	195	89,00
	ACSBL-151240BL	4	16	9090171007145	195	25,00
	ACSS-151240	6	24	9090171004588	195	25,00
	ACSS-321240	1	12	9090171007350	195	50,00
	ACSSL-151240BL	4	16	9090171007152	195	25,00
	ALD-051630	1	12	9020605163000	177	72,00
	ALD-056030	1	6	9020605603001	177	106,00
	ARP-072730	10	50	9090171000467	311	5,00
	ARP-072764	10	50	9090171000474	311	5,00
	ARP-102730	10	50	9090171000481	311	6,00
	ARP-102740	10	50	9090171005486	311	6,00
	ARP-102764	10	50	9090171000498	311	6,00
	ARP-122430	10	50	9090171003185	322	14,00
	ARP-122440	10	50	9090171003192	322	14,00
	ARP-122730	10	50	9090171000504	311	7,00

	COD.	INNER pz	MASTER pz	EAN	PAG.	€
	ARP-122740	10	50	9090171005493	311	7,00
	ARP-122764	10	50	9090171000511	311	7,00
	ARP-152730	10	50	9090171000528	311	8,00
	ARP-152764	10	50	9090171000535	311	8,00
	ARP-202730	10	50	9090171013726	311	9,00
	ARP-202730BL	6	24	9090171013757	363	8,50
	ARP-202740	10	50	9090171013733	311	9,00
	ARP-202740BL	6	24	9090171013764	363	8,50
	ARP-202765	10	50	9090171013740	311	9,00
	ARP-202765BL	6	24	9090171013771	363	8,50
	ARPD-202730	10	50	9090171017243	311	11,50
	ARPD-202740	10	50	9090171017250	311	11,50
	ARPD-202765	10	50	9090171017267	311	11,50
	ATP-CTY	10	50	9090171017458	169	16,00
	ATPLVT	1	24	9090171010114	203	19,00
	AXO-0540B	12	24	9090171010282	215	38,00
	AXO-109030	1	6	9090171004861	215	65,00
	AXO-109040	1	6	9090171004878	215	65,00
	AXO-1GU10B	12	24	9090171010268	213	20,00
	AXO-1GU10C	12	24	9090171018325	213	20,00
	AXO-1GU10G	12	24	9090171018349	213	20,00
	AXO-1GU10N	12	24	9090171018301	213	20,00
	AXO-1GU10SB	12	24	9090171018226	213	23,00
	AXO-1GU10SC	12	24	9090171018264	213	23,00
	AXO-1GU10SG	12	24	9090171018288	213	23,00
	AXO-1GU10SN	12	24	9090171018240	213	23,00
	AXO-209030	1	6	9090171004847	215	77,00
	AXO-2GU10B	12	24	9090171010275	213	29,00
	AXO-2GU10C	12	24	9090171018332	213	29,00
	AXO-2GU10G	12	24	9090171018356	213	29,00
	AXO-2GU10N	12	24	9090171018318	213	29,00
	AXO-2GU10SB	12	24	9090171018233	213	31,00
	AXO-2GU10SC	12	24	9090171018271	213	31,00
	AXO-2GU10SG	12	24	9090171018295	213	31,00
	AXO-2GU10SN	12	24	9090171018257	213	31,00
<b>B</b>	BALUX12	1	1	9090171014013	379	226,00
	BALUX5	1	10	9090171014662	379	101,00
	BAN100-CLAS	1	1	9090171014006	378	42,00
	BAN100-FILCL	1	1	9090171013979	378	42,00
	BAN100-FILMX	1	1	9090171013993	378	42,00
	BAN100-FILST	1	1	9090171013986	378	42,00
	BAN100-SPEC	1	1	9090171018998	378	38,00
	BAN100-STRIP	1	1	9090171018981	378	38,00
	BAN133-CLAS	1	1	9090171013962	378	50,00
	BAN133-FILCL	1	1	9090171013931	378	50,00
	BAN133-FILMX	1	1	9090171013955	378	50,00
	BAN133-FILST	1	1	9090171013948	378	50,00
	BAN40-PROFILI	1	1	9090171019926	378	38,00
	BCP-122840	1	6	9090171008814	86	29,00
	BCP-183340	1	6	9090171008821	86	36,00
	BCP-243840	1	6	9090171008838	86	48,00
	BCP-323840	1	6	9090171008845	86	53,00
	BCS-142530	1	10	9090171008913	87	19,00
	BCS-142540	1	10	9090171008920	87	19,00
	BCS-203030	1	10	9090171008937	87	26,00
	BCS-203040	1	10	9090171008944	87	26,00
	BCS-243530	1	10	9090171008951	87	31,00
	BCS-243540	1	10	9090171008968	87	31,00
	BCS-323930	1	10	9090171008975	87	38,00
	BCS-323940	1	10	9090171008982	87	38,00
	BCSMA-243800	1	10	9090171012415	352	67,00
	BNRBI-2000	1	10	9090171012170	269	53,00
	BNRNE-2000	1	10	9090171012187	269	53,00
	BNRPT-BI	1	10	9090171017373	271	20,00
	BNRPT-NE	1	10	9090171017366	271	20,00
	BSS-024000	1	40	9090171018363	375	31,00
<b>C</b>	CFIP-AR111	1	16	9020611101003	83	41,00
	CF2P-AR111	1	8	9020611102000	83	62,00
	CF3P-AR111	1	8	9020611103007	83	84,00
	CFAR-102030	1	8	9020102030140	243	43,00
</						



	COD.	INNER pz	MASTER pz	EAN	PAG.	€
	CRL-2425330	1	20	9090171007862	326	23,00
	CRL-2425340	1	20	9090171007879	326	23,00
	CRT3-014000	1	24	9090171009798	218	26,00
	CRT3E-010340	1	40	9090171009804	218	60,00
	CRT6-054000	1	24	9090171009811	218	59,00
	CRT6E-050340	1	50	9090171009828	218	83,00
	CRW-G3SMART	1	1	9090171012835	378	19,00
	CRW-G3SP	1	1	9090171012866	378	19,00
	CRW-KLR	1	1	9090171012859	378	19,00
	CTLRF	1	100	9090171019025	115	46,00
	CTLSMA	9	90	9090171012507	355	24,00
	CTLSMA-ACRGGW	10	180	9090171012446	351	37,00
	CTY-604540	1	1	9090171012408	169	372,00
	DALI310	1	4	9090171007510	255	115,00
	DIM-010	1	100	9090171019032	57	58,00
	DIM-PWM	1	100	9090171019018	115	46,00
	DMASI-1009540	1	4	9090171014020	157	120,00
	DMASI-2009540	1	3	9090171014037	157	252,00
	DOBIG-154530	6	12	9090171015751	179	72,00
	DOBIG-154540	6	12	9090171015768	179	72,00
	DOBIG-SPK	1	100	9090171015782	179	11,00
	DOBIN-154530	6	12	9090171015737	179	72,00
	DOBIN-154540	6	12	9090171015744	179	72,00
	DOBIN-SPK	1	100	9090171015775	179	11,00
	DOMBI-061230	6	24	9090171020182	199	65,00
	DOMBI-061240	6	24	9090171020199	199	65,00
	DOMNE-061230	6	24	9090171020205	199	65,00
	DOMNE-061240	6	24	9090171020212	199	65,00
	DR60	1	10	9090171004946	191	46,00
	DR80	1	6	9090171004953	191	67,00
	DRIMPQ40	1	1	9300040001236	55	50,00
	DRIMPQ42	1	100	9090171003871	55	40,00
	DRIMPQ42D	1	48	9090171004236	55	54,00
	DSCD-15011040	1	1	9090171007664	150	264,00
	DSCD-20011040	1	1	9090171013009	150	348,00
	DSCD-GRIK08	1	1	9090171007688	150	21,00
	DSCD150-120S	1	10	9090171009842	150	41,00
	DSCM-10011040	1	4	9090171017892	151	108,00
	DSCM-15011040	1	4	9090171017908	151	166,00
	DSCM-20011040	1	4	9090171017915	151	214,00
	DSCM-BK	1	20	9090171017922	151	26,00
	DSD-061230	10	50	9090171013672	314	20,00
	DSD-061240	10	50	9090171013689	314	20,00
	DSD-061260	10	50	9090171013696	314	20,00
	DSD-063830	10	50	9090171005660	314	8,00
	DSD-063840	10	50	9090171005677	314	8,00
	DSD-063860	10	50	9090171005684	314	8,00
	DVS-059040	1	12	9090171008463	200	56,00
	DVS-109040	1	8	9090171007701	201	103,00
	ECLISSE150	1	16	9090171007534	253	98,00
	ECLISSE250	1	8	9090171007541	253	173,00
	ELG3-062730BL	12	48	9090171003888	364	3,00
	ELG3-062740BL	12	48	9090171014174	364	3,00
	ELG3-062764BL	12	48	9090171003895	364	3,00
	ELG3-092730BL	12	48	9090171003901	364	3,50
	ELG3-092740BL	12	48	9090171014181	364	3,50
	ELG3-092764BL	12	48	9090171003918	364	3,50
	ELG3-122730BL	12	48	9090171003925	364	4,00
	ELG3-122740BL	12	48	9090171014198	364	4,00
	ELG3-122764BL	12	48	9090171003932	364	4,00
	ELG3-152730BL	12	48	9090171003949	364	6,00
	ELG3-152740BL	12	48	9090171014204	364	6,00
	ELG3-152764BL	12	48	9090171003956	364	6,00
	ELG3-172730BL	12	48	9090171017014	364	6,70
	ELG3-172740BL	12	48	9090171017021	364	6,70
	ELG3-172764BL	12	48	9090171017038	364	6,70
	ELHTG-031430BL	12	48	9090171004045	365	2,40
	ELHTG-031440BL	12	48	9090171014105	365	2,40
	ELHTG-031464BL	12	48	9090171004052	365	2,40
	ELHTG-032730BL	12	48	9090171004069	365	2,40
	ELHTG-032740BL	12	48	9090171014112	365	2,40
	ELHTG-032764BL	12	48	9090171004076	365	2,40
	ELHTG-061430BL	12	48	9090171004083	365	2,60
	ELHTG-061440BL	12	48	9090171014136	365	2,60
	ELHTG-061464BL	12	48	9090171004090	365	2,60
	ELHTG-062730BL	12	48	9090171004106	365	2,60
	ELHTG-062740BL	12	48	9090171014143	365	2,60
	ELHTG-062764BL	12	48	9090171004113	365	2,60
	ELHTG-081430BL	12	48	9090171014228	365	3,50
	ELHTG-081440BL	12	48	9090171014235	365	3,50
	ELHTG-081465BL	12	48	9090171014242	365	3,50
	ELHTG-082730BL	12	48	9090171014259	365	3,50
	ELHTG-082740BL	12	48	9090171014266	365	3,50
	ELHTG-082765BL	12	48	9090171014273	365	3,50
	ELK110-061030BL	12	48	9090171004120	366	3,50
	ELK110-061040BL	12	48	9090171014211	366	3,50
	ELK110-061064BL	12	48	9090171004137	366	3,50
	ELM1-031430BL	12	48	9090171003963	365	2,40
	ELM1-031440BL	12	48	9090171014129	365	2,40
	ELM1-031464BL	12	48	9090171003970	365	2,40
	ELM1-061430BL	12	48	9090171003987	365	2,60
	ELM1-061440BL	12	48	9090171014150	365	2,60
	ELM1-061464BL	12	48	9090171003994	365	2,60
	ELM1-081430BL	12	48	9090171014280	365	3,50
	ELM1-081440BL	12	48	9090171014297	365	3,50
	ELM1-081465BL	12	48	9090171014303	365	3,50
	ELM1C-031430BL	12	48	9090171004007	365	2,40
	ELM1C-031464BL	12	48	9090171004014	365	2,40
	ELM1C-061430BL	12	48	9090171004021	365	2,60
	ELM1C-061440BL	12	48	9090171014167	365	2,60

	COD.	INNER pz	MASTER pz	EAN	PAG.	€
	ELMTC-061464BL	12	48	9090171004038	365	2,60
	ENIB-GU10	6	24	9090171015171	233	23,00
	ENIBOR-GU10	6	24	9090171015195	233	26,00
	ENIN-GU10	6	24	9090171015188	233	23,00
	ENINOR-GU10	6	24	9090171015294	233	26,00
	ENRB-GU10	6	24	9090171015201	233	26,00
	ENRN-GU10	6	24	9090171015218	233	26,00
	ENSB-2GU10	1	12	9090171015232	231	37,00
	ENSB-3GU10	1	12	9090171015256	231	60,00
	ENSB-GU10	6	24	9090171015225	231	23,00
	ENSN-2GU10	1	12	9090171015249	231	37,00
	ENSN-3GU10	1	12	9090171015263	231	60,00
	ENSN-GU10	6	24	9090171015300	231	23,00
	ENSTYB-GU10	6	24	9090171015270	229	50,00
	ENSTYN-GU10	6	24	9090171015287	229	50,00
	ESQBB160-2GU10	1	12	9090171014778	235	50,00
	ESQBB80-GU10	1	24	9090171014785	235	29,00
	ESQBB96-GU10	1	24	9090171014792	235	35,00
	ESQBG160-2GU10	1	12	9090171014808	235	50,00
	ESQBG80-GU10	1	24	9090171014815	235	29,00
	ESQBG96-GU10	1	24	9090171014822	235	35,00
	ESQBOR96-GU10	1	24	9090171014839	239	35,00
	ESQNB160-2GU10	1	12	9090171014846	235	50,00
	ESQNB80-GU10	1	24	9090171014853	235	29,00
	ESQNB96-GU10	1	24	9090171014860	235	35,00
	ESQNG160-2GU10	1	12	9090171014877	235	50,00
	ESQNG80-GU10	1	24	9090171014884	235	29,00
	ESQNG96-GU10	1	24	9090171014891	235	35,00
	ESQNR96-GU10	1	24	9090171014907	239	35,00
	ESRBB80-GU10	1	24	9090171014679	237	29,00
	ESRBB96-GU10	1	24	9090171014686	237	32,00
	ESRBG80-GU10	1	24	9090171014693	237	29,00
	ESRBG96-GU10	1	24	9090171014709	237	32,00
	ESRBOR96-GU10	1	24	9090171014716	239	32,00
	ESRN80-GU10	1	24	9090171014723	237	29,00
	ESRN96-GU10	1	24	9090171014730	237	32,00
	ESRNG80-GU10	1	24	9090171014747	237	29,00
	ESRNG96-GU10	1	24	9090171014754	237	32,00
	ESRNR96-GU10	1	24	9090171014761	239	32,00
	EVOS-1209540	1	1	9090171010589	167	396,00
	EVOS-1509540	1	1	9090171010596	167	420,00
	EVOS-609540	1	1	9090171010565	167	238,00
	EVOS-909540	1	1	9090171010572	167	336,00
	EXPO-CENT	1	4	9090171001891	379	67,00
	EXPO-GOSMART	1	1	9090171019742	378	43,00
	EXPO-LUME	1	4	9090171020656	378	234,00
	EXPO-PR	1	4	9090171010121	379	77,00
	EXPO-PRIMO	1	4	9090171000429	378	24,00
	EXPOC-3VASCH	1	4	9090171013825	379	84,00
	EXTR-1501250	1	1	9090171004595	149	348,00
	EXTR-KIT	2	25	9090171004601	149	24,00
	EXTR-ROTAB	2	25	9090171004618	149	46,00
	EXTR-SENS	1	25	9090171004656	149	77,00
	EXTR3-LENS3070	1	25	9090171017151	149	53,00
	EXTR3-LENS40120	1	25	9090171017168	149	53,00
	EXTR3-LENS5090	1	25	9090171017144	149	53,00
	EXTRDL-1501250	1	25	9090171016802	149	432,00
	FC-309540	1	6	9090171009729	284	77,00
	FC-509540	1	4	9090171003697	284	149,00
	FC-809540	1	4	9090171003680	284	173,00
	FGF-011427	12	48	9013011427002	326	4,30
	FGF-011450	12	48	9090171003024	326	4,30
	FGY-020040	12	48	9090171010237	372	8,00
	FRB-121830	1	20	9090171009231	45	32,00
	FRB-121840	1	20	9090171009248	45	32,00
	FRB-182330	1	20	9090171008005	45	37,00
	FRB-182340	1	20	9090171008012	45	37,00
	FRBS-121830	1	20	9090171009255	45	32,00
	FRBS-121840	1	20	9090171009286	45	32,00
	FRBS-182330	1	20			

COD.	INNER pz	MASTER pz	EAN	PAG.	€
FT-066840	1	40	9090171007008	68	10,00
FTBI-150	10	50	9090171005875	240	7,00
FTGR-150	10	50	9090171005905	240	7,00
FTNE-150	10	50	9090171005899	240	7,00
FTP-109000	10	40	9090171015799	65	33,00
FTP-151200	10	40	9090171015805	65	41,00
FTP-201400	10	40	9090171015812	65	45,00
FTP-281900	1	10	9090171015829	65	61,00
FTP-351900	1	10	9090171015836	65	68,00
FTS-301330	3	30	9090171015997	66	65,00
FTS-301340	3	30	9090171012149	66	65,00
FTS-602330	3	9	9090171016000	66	120,00
FTS-602340	3	9	9090171012156	66	120,00
FTSD-221740	2	8	9032217400008	67	120,00
FTSD-282330	2	8	9032823300006	67	146,00
FTSD-282340	2	8	9032823400003	67	146,00
FTSD-392330	2	8	9033923300002	67	173,00
FTSD-501730	2	8	9035017300004	67	182,00
FVT8-096040	25	25	9023096040140	343	6,00
FVT8-096065	25	25	9023096065143	343	6,00
FVT8-149040	1	25	9090171001709	343	11,00
FVT8-149065	25	25	9090171001716	343	11,00
FVT8-181230	10	10	9090171005400	343	9,00
FVT8-181240	25	25	9023181240141	343	9,00
FVT8-181265	25	25	9023181265144	343	9,00
FVT8-221530	10	10	9090171005417	343	11,00
FVT8-221540	25	25	9023221540149	343	11,00
FVT8-221565	25	25	9023221565142	343	11,00
FVT8M-096040	1	25	9090171017380	343	5,00
FVT8M-096065	1	25	9090171017397	343	5,00
FVT8M-181240	1	25	9090171013894	343	8,00
FVT8M-181265	1	25	9090171013900	343	8,00
FVT8M-221540	1	25	9090171013917	343	9,00
FVT8M-221565	1	25	9090171013924	343	9,00
G3SMA-142700	10	50	9090171016925	349	21,00
G3SP-102730	6	24	9090171006308	323	13,00
G3SP-102730BL	6	24	9090171006940	362	13,00
G3SP-102764	6	24	9090171006322	323	13,00
G3SP-102764BL	6	24	9090171006957	362	13,00
GDN-051530	1	24	9020605153001	177	50,00
GDN-058030	1	6	9020605803005	177	101,00
GNS-081240	1	12	9090171019728	197	93,50
GRD-144840	1	10	9090171018387	371	69,00
GUSMA120-061000	10	50	9090171016963	349	16,00
GUSMA38-061000	10	50	9090171016970	349	16,00
GXLED-055330	6	24	9090171001136	339	16,00
GXLED-055340	6	24	9090171001143	339	16,00
H1GSMA-061400	10	50	9090171016932	349	16,00
HO-129540	1	12	9090171003734	162	48,00
HR80G120-202730	6	24	9090171016864	309	12,00
HR80G120-202740	6	24	9090171016871	309	12,00
HR80G120-202760	6	24	9090171016888	309	12,00
HR80G120-242730	6	24	9090171016895	309	15,00
HR80G120-242740	6	24	9090171016901	309	15,00
HR80G120-242760	6	24	9090171016918	309	15,00
HR80G3-092730	10	50	9090171005981	308	3,00
HR80G3-092740	10	50	9090171005998	308	3,00
HR80G3-092760	10	50	9090171006001	308	3,00
HR80G3-112730	10	50	9090171006018	308	3,50
HR80G3-112740	10	50	9090171006025	308	3,50
HR80G3-112764	10	50	9090171006032	308	3,50
HR80G3-152730	10	50	9090171006049	308	6,00
HR80G3-152740	10	50	9090171006056	308	6,00
HR80G3-152764	10	50	9090171006063	308	6,00
HR80G3-172730	10	50	9090171016987	308	6,50
HR80G3-172740	10	50	9090171016994	308	6,50
HR80G3-172764	10	50	9090171017007	308	6,50
HR80G95-152730	6	24	9090171016833	309	9,50
HR80G95-152740	6	24	9090171016840	309	9,50
HR80G95-152760	6	24	9090171016857	309	9,50
HR80H1G-041430	10	50	9090171015393	308	1,90
HR80H1G-041440	10	50	9090171015409	308	1,90
HR80H1G-041464	10	50	9090171015416	308	1,90
HR80H1G-042730	10	50	9090171015423	308	1,90
HR80H1G-042740	10	50	9090171015430	308	1,90
HR80H1G-042764	10	50	9090171015447	308	1,90
HR80M1-041430	10	50	9090171015454	308	1,90
HR80M1-041440	10	50	9090171015461	308	1,90
HR80M1-041464	10	50	9090171015478	308	1,90
HRDG125-242730	6	24	9090171017274	309	18,00
HRDG125-242740	6	24	9090171017281	309	18,00
HRDG125-242760	6	24	9090171017298	309	18,00
HRCG3-102727	10	50	9090171003796	307	6,00
HRCG3-122727	10	50	9090171003802	307	7,00
HRH1G-061427	10	50	9090171003772	307	4,80
HRH1G-062727	10	50	9090171003789	307	4,80
HRM1-061427	10	50	9090171003765	307	4,80
INDG3-112727	10	50	9090171020649	298	10,50
INDG3-112740	10	50	9090171020571	298	10,50
INDH1G-061427	10	50	9090171020533	298	6,00
INDH1G-061440	10	50	9090171020540	298	6,00
INDM1-061427	10	50	9090171020557	298	6,00
INDM1-061440	10	50	9090171020564	298	6,00
ING125-102727	5	20	9090171002416	294	13,00
ING125-102740	5	20	9090171010145	294	13,00
ING125-102760	5	20	9090171005011	294	13,00
ING125-122727	5	20	9090171019148	294	13,00
ING125-122740	5	20	9090171018929	294	13,00
ING125-122760	5	20	9090171019155	294	13,00
ING125-162727	5	20	9090171012699	294	20,00

COD.	INNER pz	MASTER pz	EAN	PAG.	€
ING125-162740	5	20	9090171012682	294	20,00
ING3-042727	10	50	9013042727010	292	4,00
ING3-042727BL2	6	48	9090171006964	359	9,00
ING3-042740	10	50	9090171010060	292	4,00
ING3-042740BL2	6	48	9090171007190	359	9,00
ING3-082727	10	50	9013082727018	292	4,80
ING3-082727BL2	6	48	9090171006735	359	10,00
ING3-082740	10	50	9090171010077	292	4,80
ING3-082740BL2	6	48	9090171007206	359	10,00
ING3-122727	10	50	9090171018912	292	7,00
ING3-122727BL2	6	48	9090171019117	359	16,00
ING3-122740	10	50	9090171019094	292	7,00
ING3-122740BL2	6	48	9090171018950	359	16,00
ING3-162727	10	50	9090171012668	292	16,00
ING3-162740	10	50	9090171012675	292	16,00
ING3P-082727	10	50	9090171005646	292	5,80
ING3P-082727BL2	6	48	9090171006742	359	13,00
ING3P-082740	10	50	9090171010084	292	5,80
ING3P-082740BL2	6	48	9090171007213	359	13,00
ING3S-112727	10	50	9090171019810	303	9,50
ING3SD-082727	10	50	9090171019803	303	8,00
ING3SMA-072700	10	50	9090171016949	349	17,00
ING95-082727	5	20	9090171010954	294	9,50
ING95-082740	5	20	9090171010961	294	9,50
INH1G-021427	10	50	9013021427016	296	3,20
INH1G-021427BL2	6	48	9090171006636	358	7,00
INH1G-022727	10	50	9013022727016	296	3,20
INH1G-022727BL2	6	48	9090171006643	358	7,00
INH1G-041427	10	50	9013041427102	296	3,80
INH1G-041427BL2	6	48	9090171006674	358	8,00
INH1G-041440	10	50	9090171010015	296	3,80
INH1G-041440BL2	6	48	9090171007169	358	8,00
INH1G-042727	10	50	9013042727119	296	3,80
INH1G-042727BL2	6	48	9090171006681	358	8,00
INH1G-042740	10	50	9090171010022	296	3,80
INH1G-042740BL2	6	48	9090171007176	358	8,00
INH1G-061427	10	50	9090171010633	296	4,80
INH1G-061427BL2	6	48	9090171010671	358	10,00
INH1G-061440	10	50	9090171010657	296	4,80
INH1G-061440BL2	6	48	9090171010695	358	10,00
INH1G-062727	10	50	9090171010640	296	4,80
INH1G-062727BL2	6	48	9090171010688	358	10,00
INH1G-062740	10	50	9090171010664	296	4,80
INH1G-062740BL2	6	48	9090171010701	358	10,00
INH1GSD-061427	10	50	9090171019797	303	7,00
INM1-021427	10	50	9013021427023	296	3,20
INM1-021427BL2	6	48	9090171006650	358	7,00
INM1-041427	10	50	9013041427034	296	3,80
INM1-041427BL2	6	48	9090171006698	358	8,00
INM1-041440	10	50	9090171010039	296	3,80
INM1-041440BL2	6	48	9090171007183	358	8,00
INM1-061427	10	50	9090171010831	296	4,80
INM1-061427BL2	6	48	9090171010855	358	10,00
INM1-061440	10	50	9090171010848	296	4,80
INM1-061440BL2	6	48	9090171010862	358	10,00
INM1C-021427	10	50	9013021427030	296	3,20
INM1C-021427BL2	6	48	9090171006667	359	7,00
INM1C-041427	10	50	9013041427041	296	3,80
INM1C-041427BL2	6	48	9090171006728	359	8,00
INM1C-041440	10	50	9090171010053	296	3,80
INM1C-041440BL2	6	48	9090171007237	359	8,00
INSDG3-112730	10	50	9090171020625	299	11,00
INSDG3-112740	10	50	9090171020632	299	11,00
INSDH1G-061430	10	50	9090171020588	299	6,70
INSDH1G-061440	10	50	9090171020595	299	6,70
INSDM1-061430	10	50	9090171020601	299	6,70
INSDM1-061440	10	50	9090171020618	299	6,70
INSG125-102730	5	20	9090171002546	295	13,00
INSG125-102740	5	20	9090171010152	295	13,00
INSG125-102760	5	20	9090171002553	295	13,00
INSG125-122730	5	20	9090171019162	295	13,00
INSG125-122740	5	20	9090171019179	295	13,00
INSG125-122760	5	20	9090171019186	295	13,00
INSG125-162730	5	20	9090171012651	295	20,00
INSG125-162740	5	20	9090171012644	295	20,00
INSG125-					



COD.	INNER pz	MASTER pz	EAN	PAG.	€
INSG95-082730	5	20	9090171019216	295	9,50
INSG95-082740	5	20	9090171019223	295	9,50
INSG95-082760	5	20	9090171019230	295	9,50
INSH1G-041430	10	50	9090171002423	297	3,80
INSH1G-041430BL2	6	48	9090171006766	360	8,00
INSH1G-041440	10	50	9090171010374	297	3,80
INSH1G-041440BL2	6	48	9090171010978	360	8,00
INSH1G-041460	10	50	9090171002430	297	3,80
INSH1G-041460BL2	6	48	9090171006773	360	8,00
INSH1G-042730	10	50	9090171002447	297	3,80
INSH1G-042730BL2	6	48	9090171006780	360	8,00
INSH1G-042740	10	50	9090171010381	297	3,80
INSH1G-042740BL2	6	48	9090171010985	360	8,00
INSH1G-042760	10	50	9090171002454	297	3,80
INSH1G-042760BL2	6	48	9090171006797	360	8,00
INSH1G-061430	10	50	9090171010718	297	4,80
INSH1G-061430BL2	6	48	9090171010770	360	10,00
INSH1G-061440	10	50	9090171010732	297	4,80
INSH1G-061440BL2	6	48	9090171010794	360	10,00
INSH1G-061460	10	50	9090171010756	297	4,80
INSH1G-061460BL2	6	48	9090171010817	360	10,00
INSH1G-062730	10	50	9090171010725	297	4,80
INSH1G-062730BL2	6	48	9090171010787	360	10,00
INSH1G-062740	10	50	9090171010749	297	4,80
INSH1G-062740BL2	6	48	9090171010800	360	10,00
INSH1G-062760	10	50	9090171010763	297	4,80
INSH1G-062760BL2	6	48	9090171010824	360	10,00
INSM1-041430	10	50	9090171002461	297	3,80
INSM1-041430BL2	6	48	9090171006803	360	8,00
INSM1-041440	10	50	9090171010398	297	3,80
INSM1-041440BL2	6	48	9090171011029	360	8,00
INSM1-041460	10	50	9090171002478	297	3,80
INSM1-041460BL2	6	48	9090171006810	360	8,00
INSM1-061430	10	50	9090171010879	297	4,80
INSM1-061430BL2	6	48	9090171010909	360	10,00
INSM1-061440	10	50	9090171010886	297	4,80
INSM1-061440BL2	6	48	9090171010916	360	10,00
INSM1-061460	10	50	9090171010893	297	4,80
INSM1-061460BL2	6	48	9090171010923	360	10,00
INSM1C-041430	10	50	9090171002485	297	3,80
INSM1C-041430BL2	6	48	9090171006841	361	8,00
INSM1C-041440	10	50	9090171010411	297	3,80
INSM1C-041460	10	50	9090171002492	297	3,80
INSM1C-041460BL2	6	48	9090171006858	361	8,00
INSTB-071430	10	50	9090171015645	300	5,30
INSTB-071440	10	50	9090171015652	300	5,30
INSTB-071460	10	50	9090171015669	300	5,30
INSTB-092730	10	50	9090171015683	300	7,70
INSTB-092740	10	50	9090171015690	300	7,70
INSTB-092760	10	50	9090171015706	300	7,70
INSTOR-041430	10	50	9090171002508	297	3,80
INSTOR-041430BL2	6	48	9090171006827	360	8,00
INSTOR-041440	10	50	9090171010404	297	3,80
INSTOR-041460	10	50	9090171002515	297	3,80
INSTOR-041460BL2	6	48	9090171006834	360	8,00
INSTOR-061430	10	50	9090171014075	297	4,80
INSTOR-061440	10	50	9090171014082	297	4,80
INSTOR-061460	10	50	9090171014099	297	4,80
INTB-041427	10	50	9090171015560	300	4,30
INTB-041427BL	12	48	9090171015577	359	4,00
INTB-041440	10	50	9090171015584	300	4,30
INTB-071427	10	50	9090171015591	300	5,30
INTB-071427BL	12	48	9090171015607	359	5,00
INTB-071440	10	50	9090171015614	300	5,30
INTB-092727	10	50	9090171015621	300	7,70
INTB-092727BL	12	48	9090171015638	359	7,50
INTB-092740	10	50	9090171015676	300	7,70
INTOR-041427	10	50	9090171002881	296	3,80
INTOR-041427BL2	6	48	9090171006704	358	8,00
INTOR-041440	10	50	9090171010046	296	3,80
INTOR-061427	10	50	9090171014051	296	4,80
INTOR-061440	10	50	9090171014068	296	4,80
INVG125-082722	5	20	9090171002607	305	19,00
INVG125-102722	5	20	9090171002614	305	21,00
INVG125D-122722	5	20	9090171019193	305	24,00
INVG200-082722	1	4	9090171005639	305	79,00
INVG3-082722	10	50	9090171002591	304	6,70
INVM1-041422	10	50	9090171002560	304	6,00
INVM1C-041422	10	50	9090171002584	304	6,00
INVM1D-041422	10	50	9090171002577	304	7,50
INVP-082722	10	50	9090171002638	305	8,00
INVPD-122722	1	4	9090171019209	305	13,00
INVPS160-082722	1	4	9090171005622	305	77,00
INVTOR-041422	10	50	9090171002652	304	6,00
ITLR-186040	1	6	9090171012019	145	42,00
ITLR-361240	1	6	9090171012026	145	62,00
ITLR-361265	1	6	9090171016437	145	62,00
ITLR-481540	1	6	9090171012040	145	84,00
ITLR-481565	1	6	9090171016444	145	84,00
ITLR-601540	1	6	9090171012057	145	91,00
ITLRD-361240	1	6	9090171015317	145	101,00
ITLRD-481540	1	6	9090171015324	145	120,00
ITLRD-601540	1	6	9090171015331	145	130,00
ITLRE-401240	1	6	9090171011180	145	156,00
ITLRE-401540	1	6	9090171011197	145	166,00
ITLRE-601540	1	6	9090171012023	145	182,00
ITO-030040	12	24	9090171007114	373	7,50
JESSY-AP115	1	18	9090171017960	259	33,00
JESSY-AP125	1	12	9090171017939	259	33,00
JESSY-AP150	1	12	9090171017946	261	35,00

COD.	INNER pz	MASTER pz	EAN	PAG.	€
JESSY-AP180	1	9	9090171017953	261	36,00
JESSY-AP275	1	12	9090171017984	259	38,00
JESSY-AP280	1	12	9090171017977	261	38,00
JESSY-AP360	1	12	9090171017991	259	50,00
JESSY-AR111	1	6	9090171007404	247	37,00
JESSY-BOLLE150	1	4	9090171007480	255	62,00
JESSY-BOLLE250	1	3	9090171007497	255	79,00
JESSY-RD100	1	24	9090171007428	251	9,00
JESSY-RD130	1	24	9090171007459	251	13,00
JESSY-SQ100	1	24	9090171007411	247	9,00
JESSY-SQ120	1	24	9090171007435	247	13,00
JESSY-SQ120GLASS	1	24	9090171007442	249	13,00
JESSY-SQ45GR	1	24	9090171007473	249	13,00
JESSY-SR120	1	24	9090171007466	251	13,00
JESSY2-SQ2112	1	24	9090171007398	249	24,00
JL-508540	1	8	9090171018967	283	96,00
JL-508540	1	8	9090171018974	283	151,00
K12XLED-300430	6	24	9021300430220	315	11,00
K12XLED-300430BL	6	24	9090171011401	366	10,00
K12XLED-300440	6	24	9090171011388	315	11,00
K12XLED-300440BL	6	24	9090171011395	366	10,00
K2T7LED-071030	6	24	9020071030110	315	3,40
K2T7LED-071040	6	24	9090172002088	315	3,40
K2T7LED-071060	6	24	9020071060117	315	3,40
KIT-ACR6BW	1	1	9090171011791	115	46,00
KIT-CLIP	1	100	9000585000229	56	11,00
KIT-CLIPAC230	1	100	9090171019346	111	2,20
KIT-EMG	1	18	9090171001648	56	77,00
KIT-EM62	1	48	9090171006582	56	50,00
KIT-ENDCAPS	5	100	9090171019759	111	2,00
KIT-EX-2RIP-ARC	1	1	9090171018790	377	-
KIT-EX-2RIP-FLY	1	1	9090171018806	377	-
KIT-EX-2RIP-FHG	1	1	9090171018776	377	-
KIT-EX-2RIP-PST	1	1	9090171018752	377	-
KIT-EX-2RIP-PQT	1	1	9090171018769	377	-
KIT-EX-2RIP-SHS	1	1	9090171018783	377	-
KIT-PLF	1	24	9090171001600	53	26,00
KIT-PLF120	1	12	9090171001976	53	29,00
KIT-PLF12060	1	12	9090171011142	53	32,00
KIT-PLF3060	1	20	9090171017779	53	19,00
KIT-PLFB	1	20	9090171012989	53	29,00
KIT-PLFB120	1	20	9090171017762	53	37,00
KIT-PLF120B	1	5	9090171013887	51	98,00
KIT-PLF120B	1	5	9090171013870	51	98,00
KIT-PLFS60120B	1	4	9090171017304	51	166,00
KIT-PLFS60120N	1	4	9090171017311	51	166,00
KIT-PLFSB	1	5	9090171013863	51	89,00
KIT-PLFSN	1	5	9090171013856	51	89,00
KIT-PLINE	1	150	9090171008036	56	8,00
KIT-PQ40	1	100	9000595000004	56	11,00
KIT-STARTAC230	1	200	9090171019353	111	4,80
KITFTA-060830	1	200	9090171005165	69	30,00
KLIRL	10	50	9090171011258	80	3,50
KLIRM	10	50	9090171011234	80	3,10
KLIRS	10	50	9090171011241	80	3,10
KLIRXL	10	50	9090171011319	80	5,00
KLIRXLD	10	50	9090171011326	80	5,00
KLISL	10	50	9090171011357	81	4,00
KLISL2	10	50	9090171011302	82	7,50
KLISM	10	50	9090171011272	81	3,50
KLISM2	10	50	9090171011296	82	7,00
KLISS	10	50	9090171011265	81	3,50
KLISS2	10	50	9090171011289	82	7,00
KLISXL	10	50	9090171011333	81	5,00
KLISXLD	10	50	9090171011340	81	5,00
KLR-AR	10	50	9014003050031	79	9,00
KLR-BI	10	50	9014003050017	79	8,00
KLR-CR	10	50	9014003050024	79	9,00
KLRCON-BI	10	50	9090171015089	79	13,00
KLRCON-NE	10	50	9090171015096	79	13,00
KLRFX-BI	10	50	9090171015133	79	16,00
KLRFX-BN	10	50	9090171015157	79	12,00
KLRFX-NE	10	50	9090171015140	79	16,00
KLRSC-092700	1	25	9090171008050	325	10,00
KLRXL-BI	10	50	9090171015119	79	13,00
KLRXL-NE	10	50	9090171015126	79	13,00
KLS-AR	10	50	9014003050062	79	9,00
KLS-BI	10	50	9014003050048	79	8,00
KLS-CR	10	50	9014003050055	79	9,00
KLSCON-BI	10	50	9090171015102	79	14,00
KLSCON-NE	10	50	9090171015164	79	13,00
KON170	1	8	9090171007503	25	

COD.	INNER pz	MASTER pz	EAN	PAG.	€
KPRCG-5314	1	12	9090171009163	125	67,00
KPRCG-5314-CAP	1	100	9090171013290	125	2,60
KPRCG-5314-CAPH	1	100	9090171013306	125	2,60
KPRI-2212	1	20	9090171009033	123	19,00
KPRI-2212-CAP	1	100	9090171013313	123	2,20
KPRI-2212-CAPH	1	100	9090171013320	123	2,20
KPRI-2508	1	20	9090171009019	123	23,00
KPRI-2508-CAP	1	20	9090171013337	123	2,20
KPRI-2508-CAPH	1	20	9090171013344	123	2,20
KPRI-2508-CLIP	1	20	9090171013580	123	3,90
KPRI-2508B	1	20	9090171018530	123	32,00
KPRI-2508N	1	20	9090171018592	123	32,00
KPRI-3011	1	20	9090171009088	123	25,00
KPRI-3011-CAP	1	100	9090171013351	123	2,20
KPRI-3011-CAPH	1	100	9090171013368	123	2,20
KPRI40G-2413	1	20	9090171009118	129	30,00
KPRI40G-2413-CAP	1	100	9090171013375	129	2,40
KPRI40G-2413-CAPH	1	100	9090171013382	129	2,40
KPRIC-4736	1	100	9090171009149	123	113,00
KPRIC-4736-CAP	1	100	9090171013399	123	12,00
KPRIC-4736-CAPH	1	100	9090171013405	123	12,00
KPRIC-4736-CLIP	1	100	9090171013597	123	26,00
KPRS-1611	1	20	9090171009057	127	15,00
KPRS-1611-CAP	1	20	9090171013412	127	2,20
KPRS-1611-CAPH	1	20	9090171013429	127	2,20
KPRS-1611-CLIP	1	100	9090171013603	127	3,90
KPRS-1611B	1	100	9090171018547	127	20,00
KPRS-1611N	1	20	9090171018608	127	20,00
KPRS-1708	1	20	9090171008999	127	22,00
KPRS-1708-CAP	1	20	9090171013436	127	2,20
KPRS-1708-CAPH	1	100	9090171013443	127	2,20
KPRS-1708-CLIP	1	100	9090171013610	127	3,90
KPRS-1708B	1	100	9090171018516	127	29,00
KPRS-1708N	1	20	9090171018578	127	29,00
KPRS-3537	1	100	9090171009132	131	113,00
KPRS-3537-CAP	1	100	9090171013450	131	12,00
KPRS-3537-CAPH	1	100	9090171013467	131	12,00
KPRS-3537-CLIP	1	100	9090171013627	131	16,00
KPRS-3537B	1	100	9090171018554	131	125,00
KPRS40G-1713	1	20	9090171009101	129	26,00
KPRS40G-1713-CAP	1	100	9090171013474	129	2,40
KPRS40G-1713-CAPH	1	100	9090171013481	129	2,40
KPRS40G-1713-CLIP	1	100	9090171013634	129	4,80
KPRSC-6528	1	6	9090171009194	133	67,00
KPRSC-6528-CAP	1	100	9090171013498	133	4,50
KPRSC-6528-CAPH	1	100	9090171013504	133	4,50
KPRSC-8050	1	6	9090171009200	133	84,00
KPRSC-8050-CAP	1	100	9090171013511	133	4,50
KPRSC-8050-CAPH	1	100	9090171013528	133	4,50
KPRSL-5709	1	10	9090171009156	127	35,00
KPRSL-5709-CAP	1	100	9090171013535	127	3,40
KPRSL-5709-CAPH	1	100	9090171013542	127	3,40
KPRSL-5709-CLIP	1	100	9090171013641	127	16,00
KPRVE-4217	1	10	9090171009224	131	44,00
KPRVE-4217-CAP	1	100	9090171013559	131	9,00
KPRVE-4217-CAPH	1	100	9090171013566	131	9,00
KPRVE-4217-CLIP	1	100	9090171013658	131	16,00
LLD3P-108040	1	1	9090171006223	173	228,00
LLDAL-108040	1	6	9090171006193	175	40,00
LLDBA-108040	1	6	9090171006179	175	40,00
LLDSE-108040	1	6	9090171006186	175	50,00
LMPB-023827	1	9	9090171019049	221	86,00
LMPC-023827	1	9	9090171019063	221	86,00
LMPN-023827	1	9	9090171019056	221	86,00
LNK-321240	6	24	9090171011746	139	120,00
LNK16-321240	1	10	9090171011753	139	149,00
LNK16BI-321240	1	10	9090171017403	139	149,00
LNKCN2	1	1	9090171011760	139	9,00
LNKCN2BI	1	1	9090171017410	139	9,00
LNKCN4	1	1	9090171011777	139	12,00
LNKCN4BI	1	1	9090171017427	139	12,00
LNKCNL	1	1	9090171011784	139	6,70
LNR-361230	1	10	9090171018899	75	94,00
LNR-361240	1	10	9090171018905	75	94,00
LR50-051430	6	24	9020051430060	334	5,00
LR50-051440	6	24	9090171002812	334	5,00
LR63-082730	6	24	9020082730061	334	6,70
LR63-082740	6	24	9090171002829	334	6,70
LR80-152730	6	24	9020152730069	334	9,00
LR80-152740	6	24	9090171002836	334	9,00
LTS-302718	1	20	9090171012996	329	33,00
LTS-302730	1	20	9090171010312	329	30,00
LTS-302740	1	20	9090171010329	329	30,00
LTS-502718	1	20	9090171010183	329	46,00
LTS-502722	1	20	9090171008128	329	46,00
LTS-502730	1	20	9090171008135	329	46,00
LTS-502740	1	20	9090171008142	329	46,00
LTS-504022	1	20	9090171008159	329	46,00
LTS-504030	1	20	9090171008166	329	46,00
LTS-504040	1	20	9090171008173	329	46,00
LVT-059540	1	5	9090171007626	203	166,00
LVT-159540	1	8	9090171010107	203	118,00
LX110-061030	10	50	9090171001211	313	4,00
LX110-061040	10	50	9090171002805	313	4,00
LX110-061060	10	50	9090171001228	313	4,00
LX110-081030	10	50	9090171001235	313	4,80
LX110-081040	10	50	9090171010343	313	4,80
LX110-081060	10	50	9090171001242	313	4,80
LX38-061030	10	50	9090171001174	313	4,00
LX38-061040	10	50	9090171002799	313	4,00

COD.	INNER pz	MASTER pz	EAN	PAG.	€
LX38-061060	10	50	9090171001181	313	4,00
LX38-081030	10	50	9090171001198	313	4,80
LX38-081040	10	50	9090171010336	313	4,80
LX38-081060	10	50	9090171001204	313	4,80
LX60-065330	10	50	9090171001259	313	6,00
LX60-065340	10	50	9090171010350	313	6,00
LX60-065360	10	50	9090171001266	313	6,00
LX60-085330	10	50	9090171001273	313	7,00
LX60-085340	10	50	9090171010367	313	7,00
LX60-085360	10	50	9090171001280	313	7,00
LXC110-091030	10	50	9090171017830	313	7,50
LXC110-091040	10	50	9090171017847	313	7,50
LXC110-091060	10	50	9090171017854	313	7,50
M1SMA-061400	10	50	9090171016956	349	16,00
MAGIC BOX	1	25	9090171017465	379	18,00
MGR5-486010	1	6	9090171015973	108	79,00
MIRO200	1	6	9090171007527	255	67,00
MNC-204530	1	12	9090171014983	74	132,00
MNC-204540	1	12	9090171014990	74	132,00
MNI-204530	1	12	9090171014969	74	113,00
MNI-204540	1	12	9090171014976	74	113,00
MP-014030	6	24	9090171004700	186	26,00
MP-014040	6	24	9090171004717	186	26,00
MP-036030	6	24	9090171004724	186	46,00
MP-036040	6	24	9090171004731	186	46,00
MS-066040	10	50	9090171007374	373	6,00
MW-108040	1	20	9090171007107	372	26,00
MX-1004040	5	10	9090171004533	333	122,00
MX-1004065	5	10	9021004065018	333	122,00
MX-1504040	5	10	9090171004540	333	182,00
MX-1504065	5	10	9090171002003	333	182,00
MX-402740	5	20	9020402740015	333	70,00
MX-704040	5	10	9090171004526	333	108,00
MX-704065	5	10	9020704065014	333	108,00
MXR-1004040	5	10	9090171006070	333	72,00
MXR-502740	1	10	9090171007282	333	41,00
MXR-504040	1	10	9090171007305	333	41,00
MXR-504065	1	10	9090171007312	333	41,00
NE-030040	12	24	9090171007121	373	9,60
OMR-061930	1	24	9090171018813	97	26,00
OMR-061940	1	24	9090171018820	97	26,00
OMR-243230	1	10	9090171018837	97	55,00
OMR-243240	1	10	9090171018844	97	55,00
OMS-061930	1	24	9090171018851	97	26,00
OMS-061940	1	24	9090171018868	97	26,00
OMS-243230	1	10	9090171018875	97	55,00
OMS-243240	1	10	9090171018882	97	55,00
ONHIG-061430	10	50	9021061430088	310	2,60
ONHIG-061440	10	50	9090171002713	310	2,60
ONHIG-061465	10	50	9090171002737	310	2,60
ONHIG-062730	10	50	9021062730088	310	2,60
ONHIG-062740	10	50	9090171002720	310	2,60
ONHIG-062765	10	50	9090171002744	310	2,60
ONHIG-081430	10	50	9090171007244	310	3,50
ONHIG-081440	10	50	9090171007251	310	3,50
ONHIG-081465	10	50	9090171008425	310	3,50
ONHIG-082730	10	50	9090171007268	310	3,50
ONHIG-082740	10	50	9090171007275	310	3,50
ONHIG-082765	10	50	9090171008432	310	3,50
ONMI-061430	10	50	9021061430095	310	2,60
ONMI-061440	10	50	9090171002751	310	2,60
ONMI-061465	10	50	9090171002768	310	2,60
ONMI-081430	10	50	9090171002386	310	3,50
ONMI-081440	10	50	9090171002393	310	3,50
ONMI-081465	10	50	9090171008418	310	3,50
ONMIC-061430	10	50	9021061430118	310	2,60
ONMIC-061440	10	50	9090171002775	310	2,60
ONMIC-061465	10	50	9090171002782	310	2,60
OS65P-182300	1	10	9090171014914	92	42,00
OS65P-363200	1	10	9090171014921	92	62,00
OSOB-1411940	1	12	9090171006483	91	19,00
OSOBS-1411940	1	12	9090171006476	91	41,00
OSON-1411940	1	12	9090171006469	91	19,00
OSONS-1411940	1	12	9090171006537	91	41,00
OSTOB-1421540	1	12	9090171006506	91	23,00
OSTOBP-1421540	1	12	9090171006520	91	25,00
OSTOBPS-1421540	1	12	9090171006575	91	48,00
OSTOBS-1421540	1	12	9090171006551	91	43,00
OSTON-1421540	1	12	9090171006490	91	23,00
OSTONP-1421540	1	12	9090171006513	91	25,

COD.	INNER pz	MASTER pz	EAN	PAG.	€
PASGR-101630	1	20	9090171018479	95	38,00
PASGR-101640	1	20	9090171018486	95	38,00
PAVI-014230	6	24	9090171004748	189	36,00
PAVI-014240	6	24	9090171004755	189	36,00
PAVI-038930	1	6	9090171004885	189	67,00
PAVI-038940	1	6	9090171004892	189	67,00
PAVI-078930	1	6	9090171004908	189	70,00
PAVI-078940	1	6	9090171004915	189	70,00
PAVI-1216030	1	6	9090171004922	189	120,00
PAVI-1216040	1	6	9090171004939	189	120,00
PAVI-GU10	1	6	9090171010220	187	29,00
PAV11L-047030	6	24	9090171004762	185	19,00
PAV11L-047040	6	24	9090171004779	185	19,00
PAV12L-087030	6	24	9090171004786	175	23,00
PAV12L-087040	6	24	9090171004793	175	23,00
PAVIC2L-0513030	1	6	9090171004823	185	74,00
PAVIC2L-0513040	1	6	9090171004830	185	74,00
PAVIC4L-0513030	1	6	9090171004809	185	74,00
PAVIC4L-0513040	1	6	9090171004816	185	74,00
PEOBIR-041140	1	25	9090171019827	217	32,00
PEOBIS-041040	1	25	9090171019865	217	32,00
PEOCOR-041140	1	25	9090171019841	217	32,00
PEOCOS-041040	1	25	9090171019889	217	32,00
PEOGR-041140	1	25	9090171019858	217	32,00
PEOGS-041040	1	25	9090171019896	217	32,00
PEONER-041140	1	25	9090171019834	217	32,00
PEONES-041040	1	25	9090171019872	217	32,00
PHG-1018030	1	20	9090171007718	93	26,00
PHG-1018040	1	20	9090171007725	93	26,00
PHG-2023030	1	20	9090171007732	93	38,00
PHG-2023040	1	20	9090171007749	93	38,00
PIASTRINA G E27	1	1	9019071027022	379	2,40
PIASTRINA P E14	1	1	9019071014015	379	2,40
PIASTRINA P E27	1	1	9019071027015	379	2,40
PIXYCOB-020430	12	96	9090171016482	318	5,00
PIXYCOB-020440	12	96	9090171016499	318	5,00
PIXYCOB-020464	12	96	9090171016505	318	5,00
PIXYCOB-040930	12	96	9090171016512	319	6,00
PIXYCOB-040940	12	96	9090171016529	319	6,00
PIXYCOB-040964	12	96	9090171016536	319	6,00
PIXYDIM-450930	12	96	9090171018004	320	8,00
PIXYDIM-450940	12	96	9090171018011	320	8,00
PIXYDIM-450960	12	96	9090171018028	320	8,00
PIXYDIM-650930	12	96	9090171018035	320	9,00
PIXYDIM-650940	12	96	9090171018042	320	9,00
PIXYDIM-650960	12	96	9090171018059	320	9,00
PIXYFULL-030430	12	96	9090171000283	318	6,00
PIXYFULL-030440	12	96	9090171016666	318	6,00
PIXYFULL-030464	12	96	9090171016673	318	6,00
PIXYFULL-030930	12	96	9021030930076	319	4,30
PIXYFULL-030940	12	96	9090171009972	319	4,30
PIXYFULL-030964	12	96	9090171004687	319	4,30
PIXYFULL-040930	12	96	9090171000290	319	5,00
PIXYFULL-040940	12	96	9090171010930	319	5,00
PIXYFULL-040964	12	96	9090171010947	319	5,00
PIXYFULL-050930	12	96	9090171016574	319	6,24
PIXYFULL-050940	12	96	9090171016581	319	6,24
PIXYFULL-050964	12	96	9090171016598	319	6,24
PIXYFULL-080930	12	96	9090171016604	319	7,50
PIXYFULL-080940	12	96	9090171016611	319	7,50
PIXYFULL-080964	12	96	9090171016628	319	7,50
PIXYFULL-450430	12	96	9090171016543	318	7,00
PIXYFULL-450440	12	96	9090171016550	318	7,00
PIXYFULL-450464	12	96	9090171016567	318	7,00
PIXYPLT-020430	12	96	9021020430074	318	5,00
PL-406040	6	24	9090171008029	36	53,00
PLC-102240	6	24	9090171000382	338	21,00
PLC-102740	6	24	9090171000399	338	21,00
PLD-051230	1	12	9020605123004	177	67,00
PLD-058030	1	8	9020605803029	177	106,00
PLGU10	10	1000	9090171011630	80	1,20
PLGU53	10	1000	9090171011647	80	1,20
PNY-030040	12	48	9090171010244	372	8,00
PQ-038530	6	24	9090171003154	43	11,00
PQ-038540	6	24	9090171010503	43	11,00
PQ-061230	6	24	9090171003161	43	13,00
PQ-061240	6	24	9090171010510	43	13,00
PQ-091430	6	24	9090171003178	43	16,00
PQ-091440	6	24	9090171010527	43	16,00
PQ-121730	6	24	9020121730106	43	18,00
PQ-121740	6	24	9020121740105	43	18,00
PQ-182230	6	24	9020182230102	43	23,00
PQ-182240	6	24	9020182240101	43	23,00
PQ-243030	6	12	9090171005424	43	32,00
PQ-243040	6	12	9090171003116	43	32,00
PQ42U-426040	1	6	9090171000986	35	74,00
PQA-243030	1	6	9090171002683	33	41,00
PQA-243040	1	6	9090171002690	33	41,00
PQA-421230	1	6	9090171005189	33	65,00
PQA-421240	1	6	9090171002706	33	65,00
PQA-426030	1	6	9090171002676	33	55,00
PQA-426040	1	6	9090171002669	33	55,00
PQA-426060	1	6	9090171004229	33	55,00
PQA-646040	1	4	9090171015362	33	192,00
PQA65-406040	1	4	9090171012064	34	156,00
PQA90-421230	1	6	9090171013160	33	72,00
PQA90-421240	1	6	9090171013153	33	72,00
PQA90-426030	1	6	9090171011920	33	61,00
PQA90-426040	1	6	9090171009866	33	61,00
PQAB-421240	1	4	9090171017052	29	55,00

COD.	INNER pz	MASTER pz	EAN	PAG.	€
PQAB-426040	1	4	9090171011937	29	48,00
PQAB90-426040	1	4	9090171016826	29	53,00
PQABUN-426040	1	4	9090171017137	29	42,00
PQAFM-6060	1	6	9090171004212	37	20,00
PQAM-426040	1	6	9090171019292	33	53,00
PQAN-421240	1	6	9090171015898	33	50,00
PQAN-426040	1	6	9090171004205	33	43,00
PQAN90-421240	1	6	9090171015874	33	59,00
PQAN90-426040	1	6	9090171015881	33	48,00
PQP-182230	6	24	9090171016451	47	30,00
PQP-182240	6	24	9090171003079	47	30,00
PQP-243030	6	24	9090171016468	47	35,00
PQP-243040	6	24	9090171003093	47	35,00
PQPLF-476240	1	4	9090171007756	49	84,00
PQR-406230	1	6	9090171011425	39	61,00
PQR-406240	1	6	9090171011418	39	61,00
PRCN-1611N	1	20	9090171019278	127	11,00
PRCN-1708N	1	20	9090171019247	127	13,00
PRCN-1818N	1	20	9090171019254	127	12,00
PRCN-2508N	1	20	9090171019261	123	13,00
PRCO-1611	1	20	9090171012071	127	5,00
PRCO-1708	1	20	9090171012095	127	6,00
PRCO-1818	1	20	9090171012101	127	5,00
PRCO-2508	1	20	9090171012088	123	5,00
PRCO-3537	1	20	9090171018561	131	17,00
PRCO-5314	1	20	9090171012118	125	8,00
PRCV-1708	1	20	9090171009002	127	4,50
PRCV-1818	1	20	9090171009071	127	4,50
PRCV-2212	1	20	9090171009040	123	4,00
PRCV-2508	1	20	9090171009026	123	4,00
PRCV-3011	1	20	9090171009095	123	7,00
PRK-183240	1	6	9090171001440	89	60,00
PRKE-183240	1	6	9090171001457	89	118,00
PRKS-183240	1	6	9090171001464	89	89,00
PRL-186030	1	10	9090171011449	39	36,00
PRL-186040	1	10	9090171011432	39	36,00
PRL-361230	1	6	9090171011463	39	53,00
PRL-361240	1	6	9090171011456	39	53,00
PSE-302730	5	20	9090171011708	331	60,00
PSE-302740	5	20	9090171013702	331	60,00
PSE-302765	5	20	9090171011715	331	60,00
PSE-402730	5	20	9090171011722	331	82,00
PSE-402740	5	20	9090171013719	331	82,00
PSE-402765	5	20	9090171011739	331	82,00
PSE-404030	5	20	9090171019940	331	86,50
PSE-404040	5	20	9090171019957	331	86,50
PSE-404065	5	20	9090171019964	331	86,50
PT-038530	6	24	9090171003123	43	9,00
PT-038540	6	24	9090171010473	43	9,00
PT-061230	6	24	9090171003130	43	12,00
PT-061240	6	24	9090171010480	43	12,00
PT-091430	6	24	9090171003147	43	15,00
PT-091440	6	24	9090171010497	43	15,00
PT-121730	6	24	9020121730007	43	17,00
PT-121740	6	24	9020121740006	43	17,00
PT-182230	6	24	9020182230003	43	21,00
PT-182240	6	24	9020182240002	43	21,00
PT-243030	6	24	9090171005431	43	30,00
PT-243040	6	24	9090171003109	43	30,00
PTOBI-209500	1	24	9090171019971	161	32,50
PTOBI-309500	1	24	9090171019988	161	39,50
PTOBI-409500	1	12	9090171019995	161	49,00
PTOCO-209500	1	24	9090171020038	161	32,50
PTOCO-309500	1	24	9090171020045	161	39,50
PTOCO-409500	1	12	9090171020052	161	49,00
PTONE-209500	1	24	9090171020007	161	32,50
PTONE-309500	1	24	9090171020014	161	39,50
PTONE-409500	1	12	9090171020021	161	49,00
PTP-182230	6	24	9090171016475	47	30,00
PTP-182240	6	24	9090171003062	47	30,00
PTP-243030	6	24	9090171016635	47	35,00
PTP-243040	6	24	9090171003086	47	35,00
PTP-365040	1	5	9090171008395	48	108,00
PTP-486040	1	5	9090171008401	48	132,00
QBBI-109030	6	24	9090171016017	225	37,00
QBBI-109040	6	24	9090171008647	225	37,00
QBBI-1511230	6	24	9090171016031	225	62,00
QBBI-1511240	6	24	9090171008654	225	62,00
QBBI-2513130	6	24	9090171016055	225	89,00
QBBI-2513140	6	24	9090171008807	225	89,00
QBBI-3516130	6	24	9090171016079	225	118,

COD.	INNER pz	MASTER pz	EAN	PAG.	€
RBLVT	1	1	9090171007633	203	43,00
RBW-109510	1	16	9090171015348	163	35,00
RBW-509510	1	12	9090171015355	163	67,00
RC-SPD	6	100	9090171001433	136	4,00
RDAC100-24	1	65	9020610024006	114	29,00
RDAC100-2467	1	100	9090171013023	114	62,00
RDAC100-2467D	1	30	9090171013122	114	125,00
RDAC120-24	1	50	9090171000863	114	32,00
RDAC150-24	1	50	9090171000870	114	35,00
RDAC150-2467D	1	15	9090171013139	114	137,00
RDAC200-24	1	36	9090171000887	114	43,00
RDAC200-2467	1	100	9090171013030	114	94,00
RDAC250-2467D	1	15	9090171013146	114	170,00
RDAC300-2467	1	100	9090171013047	114	127,00
RDAC35-24	1	100	9090171000849	114	16,00
RDAC50-2467	1	100	9090171013016	114	36,00
RDAC60-24	1	120	9090171000856	114	24,00
RDAC60-2467D	1	20	9090171013115	114	74,00
RDALD-051630	1	1	9090171009767	177	16,00
RDALD-056030	1	1	9090171009750	177	16,00
RDFTPD-1020	1	50	9090171015843	65	65,00
RDFTPD-2835	1	50	9090171015850	65	70,00
RDFTPD-60	1	50	9090171015867	66	91,00
RDGDN-051530	1	1	9090171009736	177	16,00
RDGDN-058030	1	1	9090171009743	177	16,00
RDPLD-051230	1	1	9090171009781	177	16,00
RDPLD-058030	1	1	9090171009774	177	16,00
RDPQ12	1	1	9090171005295	55	11,00
RDPQ18	1	250	9090171005301	55	11,00
RDPQ24	1	100	9090171007886	55	13,00
RDPQA24	1	100	9090171005769	55	17,00
RDPQA42	1	100	9090171005288	55	30,00
RDPQA42120	1	1	9090171016819	55	22,00
RDPQA64	1	50	9090171015379	55	23,00
RDPRK	1	1	9090171015386	89	16,00
RDPRKE	1	1	9090171017434	89	13,00
RFL100	1	40	9090171018370	375	4,80
RGLBI-098330	1	6	9090171014587	276	65,00
RGLBI-098340	1	6	9090171014600	276	65,00
RGLBI-1816330	1	6	9090171014624	276	101,00
RGLBI-1816340	1	6	9090171014648	276	101,00
RGLNE-098330	1	6	9090171014594	276	65,00
RGLNE-098340	1	6	9090171014617	276	65,00
RGLNE-1816330	1	6	9090171014631	276	101,00
RGLNE-1816340	1	6	9090171014655	276	101,00
RGMS-LENS15	1	6	9090171017663	279	2,20
RGMS-LENS24	1	6	9090171017670	279	2,20
RGMSBI-106530	1	6	9090171017595	279	70,00
RGMSBI-106540	1	6	9090171017601	279	70,00
RGMSNE-106530	1	6	9090171017618	279	70,00
RGMSNE-106540	1	6	9090171017625	279	70,00
RGMT-LENS15	1	6	9090171017656	279	5,00
RGMTBI-075830	1	6	9090171017557	279	59,00
RGMTBI-075840	1	6	9090171017564	279	59,00
RGMTNE-075830	1	6	9090171017571	279	59,00
RGMTNE-075840	1	6	9090171017588	279	59,00
RGMZ-LENS15	1	6	9090171017632	279	2,20
RGMZBI-123730	1	6	9090171017519	279	70,00
RGMZBI-123740	1	6	9090171017526	279	70,00
RGMZNE-123730	1	6	9090171017533	279	70,00
RGMZNE-123740	1	6	9090171017540	279	70,00
RGOD-089030	6	24	9030890300004	71	60,00
RGOD-089040	6	24	9030890400001	71	60,00
RGOD-259030	6	24	9090171005844	71	146,00
RGOD-369030	6	24	9090171005837	71	199,00
RGOD-369040	6	24	9090171005820	71	199,00
RGSD-128030	1	6	9031280300000	275	113,00
RGSD-128040	1	6	9031280400007	275	113,00
RGSD-251130	1	6	9032511300004	275	146,00
RGSD-251140	1	6	9032511400001	275	146,00
RGSD-361130	1	6	9033611300000	275	173,00
RGSD-361140	1	6	9033611400007	275	173,00
RGT180BI-207030	1	6	9090171012750	273	58,00
RGT180BI-207040	1	6	9090171012743	273	58,00
RGT180BI-359030	1	6	9090171012767	273	79,00
RGT180BI-359040	1	6	9090171012774	273	79,00
RGT180NE-207030	1	6	9090171012804	273	58,00
RGT180NE-207040	1	6	9090171012781	273	58,00
RGT180NE-359030	1	6	9090171012811	273	79,00
RGT180NE-359040	1	6	9090171012798	273	79,00
RGTBI-258030	1	6	9090171012880	277	86,00
RGTBI-258040	1	6	9090171012897	277	86,00
RGTBI-GU10	1	6	9090171012965	277	37,00
RGTBID-309030	1	6	9090171012903	277	130,00
RGTBID-309040	1	6	9090171012910	277	130,00
RGTD-157040	1	6	9031570400007	275	106,00
RGTD-259030	1	6	9032590300001	275	156,00
RGTNE-258030	1	6	9090171012927	277	86,00
RGTNE-258040	1	6	9090171012934	277	86,00
RGTNE-GU10	1	6	9090171012972	277	37,00
RGTNED-309030	1	6	9090171012941	277	130,00
RGTNED-309040	1	6	9090171012958	277	130,00
RKITLER	1	25	9090171011371	145	106,00
RNDBI-109030	6	24	9090171016093	225	35,00
RNDBI-109040	6	24	9090171008562	225	35,00
RNDBI-1511030	6	24	9090171016116	225	58,00
RNDBI-1511040	6	24	9090171008579	225	58,00
RNDBI-2513030	6	24	9090171016130	225	79,00
RNDBI-2513040	6	24	9090171008586	225	79,00
RNDBI-3517030	6	24	9090171016154	225	103,00

COD.	INNER pz	MASTER pz	EAN	PAG.	€
RNDBI-3517040	6	24	9090171008593	225	103,00
RNDBIP-1511030	6	24	9090171016192	227	62,00
RNDBIP-1511040	6	24	9090171008715	227	62,00
RNDNE-109030	6	24	9090171016109	225	35,00
RNDNE-109040	6	24	9090171008609	225	35,00
RNDNE-1511030	6	24	9090171016123	225	58,00
RNDNE-1511040	6	24	9090171008616	225	58,00
RNDNE-2513030	6	24	9090171016147	225	79,00
RNDNE-2513040	6	24	9090171008623	225	79,00
RNDNE-3517030	6	12	9090171016161	225	103,00
RNDNE-3517040	6	24	9090171008630	225	103,00
RNDNEP-1511030	6	24	9090171016208	227	62,00
RNDNEP-1511040	6	24	9090171008739	227	62,00
RNSLLD	1	100	9091710077940	173	16,00
RVBI-E27	1	6	9090171018189	211	60,00
RVCO-E27	1	6	9090171018202	211	60,00
RVGR-E27	1	6	9090171018219	211	60,00
RVNE-E27	1	6	9090171018196	211	60,00
RW-1008540	1	4	9090171008500	285	118,00
RW-308540	1	4	9090171008470	285	48,00
RW-508540	1	4	9090171008487	285	65,00
RW-708540	1	4	9090171008494	285	94,00
RWT2-1008540	1	2	9090171014556	285	118,00
RWT2-608540	1	2	9090171014549	285	94,00
SAPS-112722	5	20	9090171008234	301	18,00
SAPS-112727	5	20	9090171008241	301	18,00
SAPS-142722	5	20	9090171008265	301	22,00
SAPS-144022	5	20	9090171008296	301	23,00
SCKSMA	25	50	9090171012491	355	32,00
SCL-020340	1	12	9090171009835	263	38,00
SENS1-18044	1	30	9090171006353	57	19,00
SENS2-18044	1	30	9090171006360	57	17,00
SENS3-36044	1	30	9090171006377	57	30,00
SENS5-36020	1	30	9090171006391	57	28,00
SENSDL1-10	1	100	9090171004694	57	66,00
SHARKD-1209540	1	1	9090171002294	166	672,00
SHARKD-609540	1	1	9090171002270	166	432,00
SHARKD-909540	1	1	9090171002287	166	504,00
SHPAR20-082730	6	24	9030827300008	336	40,00
SHPAR20-082740	6	24	9030827400005	336	40,00
SHPAR38-182730	6	24	9031827300005	336	74,00
SHPAR38-182740	6	24	9031827400002	336	74,00
SHSLIM-109540	1	24	9090171005509	159	15,00
SHSLIM-209540	1	24	9090171005516	159	19,00
SHSLIM-309540	1	12	9090171005523	159	26,00
SHSLIM-509540	1	6	9090171005530	159	40,00
SHSLIS-109540	1	12	9090171005547	159	32,00
SHSLIS-209540	1	12	9090171008180	159	36,00
SHSLIS-309540	1	6	9090171005585	159	44,00
SHSLIS-509540	1	6	9090171005554	159	56,00
SLAR111-124030	10	50	8059617675356	341	16,00
SLAR111-124040	10	50	9090171017045	341	16,00
SLDS-042240	6	24	9090171007381	373	16,00
SLY-030040	12	48	9090171010251	372	14,00
SMO-162240	1	20	9090171015492	99	17,00
SMO-242740	1	20	9090171015485	99	26,00
SMON-162240	1	20	9090171015904	99	17,00
SMON-242740	1	20	9090171015911	99	26,00
SMR-161740	1	20	9090171015515	99	17,00
SMR-242240	1	20	9090171015508	99	26,00
SMRN-161740	1	20	9090171015928	99	17,00
SMRN-242240	1	20	9090171015935	99	26,00
SMS-161540	1	20	9090171015539	99	17,00
SMS-242240	1	20	9090171015522	99	26,00
SMSN-161540	1	20	9090171015942	99	17,00
SMSN-242240	1	20	9090171015959	99	26,00
SOFFI0180	1	24	9090171007558	257	74,00
SOFFI0230	1	12	9090171007565	257	77,00
SOFFI0320	1	12	9090171007572	257	77,00
SPD-043030	6	24	9090171000702	136	13,00
SPD-043040	6	24	9022043040004	136	13,00
SPD-086030	6	24	9090171000719	136	17,00
SPD-086040	6	24	9022108604004	136	17,00
SPD-109030	6	24	9090171000689	136	20,00
SPD-109040	6	24	9022109040009	136	20,00
SPD-141230	6	24	9090171000696	136	23,00
SPD-141240	6	24	9022114124008	136	23,00
SPD-181540	6	24	9022118154001	136	35,00
SPF-091100	10	40	9090171011081	63	19,00
SPF-141400	10	40	9090171011098	63	25,00
SPF-171700	10	40			



COD.	INNER pz	MASTER pz	EAN	PAG.	€
SRS-2009540	1	6	9090171011531	155	146,00
SRS-2009560	1	6	90901710116321	155	146,00
SRS-209540	1	24	9090171011470	155	26,00
SRS-209560	1	24	90901710116253	155	26,00
SRS-30012040	1	4	9090171020458	155	259,00
SRS-3003040	1	4	9090171020489	155	259,00
SRS-3006040	1	4	9090171020472	155	259,00
SRS-3009040	1	4	9090171020465	155	259,00
SRS-309540	1	24	9090171011487	155	31,00
SRS-309560	1	24	90901710116260	155	31,00
SRS-40012040	1	4	9090171020496	155	335,00
SRS-4003040	1	4	9090171020526	155	335,00
SRS-4006040	1	4	9090171020519	155	335,00
SRS-4009040	1	4	9090171020502	155	335,00
SRS-509540	1	20	9090171011494	155	35,00
SRS-509560	1	20	90901710116277	155	35,00
SRS-709540	1	12	9090171011500	155	61,00
SRS-709560	1	12	90901710116284	155	61,00
SRSB-1009540	1	12	90901710116376	155	103,00
SRSB-1509540	1	6	90901710116383	155	130,00
SRSB-2009540	1	6	90901710116390	155	146,00
SRSB-209540	1	24	90901710116338	155	26,00
SRSB-309540	1	24	90901710116345	155	31,00
SRSB-509540	1	20	90901710116352	155	35,00
SRSB-709540	1	12	90901710116369	155	61,00
SRSBT-203640	1	16	90901710119766	156	29,00
SRSBT-303640	1	16	90901710119773	156	38,50
SRSBT-503640	1	16	90901710119780	156	69,50
SRSOL-1009040	1	5	9090171020403	198	118,00
SRSOL-2009040	1	5	9090171020410	198	166,00
SRSOL-509040	1	10	9090171020397	198	86,00
STAND50	6	24	9090171007343	287	26,00
STB-186030	6	24	9090171001501	137	31,00
STB-186040	6	24	9090171001518	137	31,00
STB-361230	6	24	9090171001525	137	50,00
STB-361240	6	24	9090171001532	137	50,00
STB-451530	6	24	9090171001587	137	64,00
STB-451540	6	24	9090171001594	137	64,00
STB-601540	6	24	9090171019285	137	79,00
STYLOBI500-053330	6	24	9090171016239	227	43,00
STYLOBI500-053340	6	24	9090171008784	227	43,00
STYLOBI600-032530	6	24	9090171016215	227	34,00
STYLOBI600-032540	6	24	9090171008760	227	34,00
STYLONE500-053330	6	24	9090171016246	227	43,00
STYLONE500-053340	6	24	9090171008791	227	43,00
STYLONE600-032530	6	24	9090171016222	227	34,00
STYLONE600-032540	6	24	9090171008777	227	34,00
SWSMA-1	6	24	9090171012460	354	50,00
SWSMA-2	6	24	9090171012477	354	58,00
SWSMA-3	6	24	9090171012484	354	62,00
TMY-062540	10	50	9090171007367	373	6,00
TR-1511830BL	6	24	9090171011975	321	19,00
TR-1511840BL	6	24	9090171011982	321	19,00
TRCOB-057830	6	24	9090171017724	321	13,00
TRCOB-057830BL	6	24	9090171017731	321	13,00
TRCOB-057840	6	24	9090171017748	321	13,00
TRCOB-057840BL	6	24	9090171017755	321	13,00
TRCOB-1011830	6	24	9090171017687	321	16,00
TRCOB-1011830BL	6	24	9090171017694	321	16,00
TRCOB-1011840	6	24	9090171017700	321	16,00
TRCOB-1011840BL	6	24	9090171017717	321	16,00
TRD-1211830BL	6	24	9090171011999	321	24,00
TRD-1211840BL	6	24	9090171012002	321	24,00
TRIPD160	6	24	9090171007091	287	36,00
TRS-057830BL	6	24	9090171009941	321	10,00
TRS-0811830BL	6	24	9090171009958	321	13,00
TRY-030040	12	24	9090171007138	373	7,50
UDBI-068030	12	24	9090171006230	208	58,00
UDBI-068040	12	24	9090171006247	208	58,00
UDGR-068030	12	24	9090171006254	208	58,00
UDGR-068040	12	24	9090171006261	208	58,00
UDNE-068030	12	24	9090171006278	208	58,00
UDNE-068040	12	24	9090171006285	208	58,00
UDRBI-1010	12	24	9090171020144	207	53,00
UDRCO-1010	12	24	9090171020168	207	53,00
UDRGR-1010	12	24	9090171020175	207	53,00
UDRNE-1010	12	24	9090171020151	207	53,00
UDSBI-1010	12	24	9090171020106	207	53,00
UDSBI-2012	12	24	9090171020069	207	82,00
UDSCO-1010	12	24	9090171020120	207	53,00
UDSCO-2012	12	24	9090171020083	207	82,00
UDSGR-1010	12	24	9090171020137	207	53,00
UDSGR-2012	12	24	9090171020090	207	82,00
UDSNE-1010	12	24	9090171020113	207	53,00
UDSNE-2012	12	24	9090171020076	207	82,00
VS-853840	12	24	9038538400000	70	40,00
VTV-052427	12	24	9090171012163	326	2,40
XT-FC	1	8	9090171017472	379	0,80
ZNR-1070	1	8	9090171019599	61	14,00
ZNR-16120	1	8	9090171019605	61	22,00
ZNR-32200	1	8	9090171019612	61	38,00
ZNS-1070	1	8	9090171019629	61	17,00
ZNS-16120	1	8	9090171019636	61	26,00
ZNS-32200	1	8	9090171019643	61	43,00
ZTD-605240	1	8	9090171006414	168	408,00



## Simbologia Symbolism



**Prodotto LED / Filamento LED**  
LED Product / LED Filament



**Prodotto dimmerabile**  
Dimmable product



**Garanzia prodotto**  
Product warranty



**Dimmerabile 1-10 V**  
1-10 V Dimmable



**Alimentazione**  
Power supply



**Dimmerabile con taglio di fase**  
Dimmable with phase cut



**Angolo luce espresso in gradi**  
Beam angle expressed in degrees



**Dimmerabile con sistema DALI**  
Dimmable with DALI system



**Grado di protezione IP**  
International protection rating



**Dimmerabile con interruttore**  
Dimmable with power switch



**Indice di resistenza agli urti IK**  
Impact protection rating



**Prodotto con controllo da remoto**  
Remote controlled product



**Classe di isolamento**  
Protective class



**Sensore PIR di presenza**  
PIR motion sensor



**Indice di resa cromatica**  
Color rendering index



**Sensore crepuscolare**  
Light sensor



**Indice unificato di abbagliamento**  
Unified glare rating



**Prodotto con funzione di emergenza**  
Product with emergency function



**Tonalità RGB**  
RGB color tones



**Pannello fotovoltaico**  
Photovoltaic panel



**Tonalità RGB + Chip LED bianco**  
RGB color tones + white LED chip



**Prodotto ricaricabile**  
Rechargeable product



**Temperatura colore correlata**  
Correlated Color Temperature



**Nuova classe energetica**  
New energy rating

# Condizioni generali di vendita

## GENERALITÀ

Le condizioni generali di vendita, qui di seguito riportate, si intendono valide per qualsiasi ordine pervenuto alla ns. Azienda e costituiscono parte essenziale di ciascun ordine. Eventuali modifiche alle presenti clausole nonché eventuali condizioni particolari dovranno essere espressamente concordate per iscritto.

## ORDINI

Le ordinazioni acquisite dalla nostra organizzazione di vendita sono soggette all'approvazione della ns. Azienda. Non si accettano ordini d'importo inferiore a € 500,00 + IVA. Ordini pervenuti con quantità inferiori agli standard indicati a listino, saranno automaticamente arrotondati all'imballo minimo, altrimenti non potranno essere gestiti.

## TRASPORTO

La merce viaggia a rischio e pericolo del Committente il quale, nel proprio interesse, deve verificare, prima del ritiro, l'integrità dei colli e la quantità della merce ricevuta. Eventuali reclami dovranno essere avanzati direttamente al vettore al momento della consegna e comunicati anche alla ns. Azienda, come indicato al capitolo "Reclami".

## CONSEGNE

I termini di consegna hanno carattere puramente indicativo e non hanno valore contrattuale. La spedizione viene effettuata unicamente con ns. corrieri convenzionati. La consegna si intende effettuata nel momento in cui la merce viene conferita al vettore. La consegna della merce con procedure d'urgenza e/o sponda idraulica, verrà effettuata solamente previa accettazione da parte dell'acquirente del costo aggiuntivo relativo al servizio richiesto. All'atto della consegna l'acquirente si impegna a verificare immediatamente e in presenza del vettore la conformità quantitativa e l'integrità dei colli inviati rispetto al D.D.T. e al packing-list, anche per consegne con pallets filmati.

## GARANZIA

La ns. Azienda garantisce che i prodotti sono esenti da vizi o difetti di fabbricazione per un periodo di 2 anni decorrente dalla data di consegna dei medesimi al Cliente. La garanzia non opererà con riferimento a quei prodotti i cui difetti sono dovuti a:

- I** Danni causati durante il trasporto; (ad eccezione di quanto indicato al capitolo "Reclami").
- II** Lampade che presentino rotture di vetri (ad eccezione di quanto indicato al capitolo "Reclami").
- III** Un uso negligente o improprio degli stessi;
- IV** Inosservanza delle istruzioni della ns. Azienda riguardanti il funzionamento, manutenzione e conservazione dei prodotti;
- V** Riparazioni o modifiche apportate dal Cliente o da soggetti terzi senza la previa autorizzazione scritta della ns. Azienda.
- VI** In ogni caso il Cliente non potrà far valere i diritti di garanzia verso la ns. Azienda, se il prezzo dei Prodotti non sia stato corrisposto alle condizioni e nei termini pattuiti, anche nel caso in cui la mancata corresponsione del prezzo alle condizioni e nei termini pattuiti si riferisca a prodotti diversi da quelli per i quali il Cliente intende far valere la garanzia. La ns. Azienda non riconosce alcuna garanzia circa la conformità dei prodotti alle norme e ai regolamenti di Paesi che non rientrano o non appartengono all'Unione Europea.

## RECLAMI

A condizione che il reclamo del Cliente sia coperto dalla garanzia e notificato nei termini sotto indicati, la ns. Azienda si impegnerà, a sua discrezione, a sostituire o riparare ciascun prodotto o le parti di questo che presentino vizi o difetti. Eventuali reclami devono essere inviati per iscritto alla ns. Azienda entro 8 giorni dal ricevimento della merce. Per reclami relativi a differenze quantitative o per colli danneggiati, o per rotture di vetri delle lampade, dovranno essere evidenziati sia nel D.D.T. che nella lettera di vettura del corriere, pena la non ns. accettazione del reclamo. Non sarà accettato nessun reclamo se non esclusivamente operato nel modo sopraindicato.

## RESI MERCE

Eventuali prodotti difettosi potranno essere resi esclusivamente previa ns. autorizzazione, con le modalità che Vi saranno comunicate dall'ufficio contestazioni al momento della richiesta di reso. Previa iniziale valutazione telefonica, o eventuale ns. intervento diretto per la prima verifica, seguiranno istruzioni da parte della ns. Azienda per effettuare il reso. I resi autorizzati dovranno essere inviati ai magazzini, corredati di regolare D.D.T. e dei relativi estremi d'acquisto. Prodotti che hanno subito un utilizzo, anche parziale, non possono essere considerati difettosi; in questo caso si valerà la convenienza della sostituzione del componente danneggiato, con spese a carico dell'acquirente. Si precisa che con il termine "materiale difettoso" è inteso qualsiasi prodotto che non abbia subito alcun utilizzo e che presenti evidenti anomalie di fabbricazione e/o di funzionamento. Non rientrano nel campo dei difettosi le lampade che presentano rotture di vetri. Altri prodotti potranno essere resi esclusivamente previa ns. autorizzazione, in porto franco, con le modalità che Vi saranno comunicate dall'ufficio contestazioni al momento della richiesta di reso ed accreditati al prezzo di acquisto dedotto un minimo del 10% per le spese di controllo, rimborso e riposizionamento a magazzino. Non potranno essere prese in considerazione richieste di resi di materiale la cui consegna risalga a più di 24 mesi prima della richiesta di restituzione, ed inoltre per articoli non presenti nell'attuale listino.

## PAGAMENTI

I pagamenti devono essere eseguiti alla ns. Azienda, alla scadenza stabilita e per l'importo pattuito, ed indirizzati unicamente alla ns. sede amministrativa. In caso di ritardo del pagamento delle scadenze, anche parziale, oltre i termini concordati, l'Azienda si riserva la facoltà a sospendere successivi invii di merce. Saranno conteggiati gli interessi bancari per il ritardo sul pagamento concordato, secondo le modalità di legge in vigore.

## PROPRIETÀ DELLA MERCE

La ns. Azienda rimane proprietaria della merce fino al completo pagamento della stessa da parte del Committente.

## MISURE E DISEGNI

Le indicazioni di misure e disegni riguardanti la costruzione dei prodotti, le dimensioni, le caratteristiche tecniche e/o fotometriche, presenti su qualsiasi pubblicazione della ns. Azienda, sono da intendersi a puro titolo informativo e possono essere soggette a modifiche senza alcun preavviso. Per informazioni aggiornate sui prodotti, visitare il sito: [www.century-italia.com](http://www.century-italia.com).

## RESPONSABILITÀ

I prodotti devono essere utilizzati e/o installati nel rispetto delle loro caratteristiche tecniche e delle istruzioni indicate, in osservanza delle disposizioni di sicurezza esistenti nel paese di utilizzo e/o d'installazione. La ns. Azienda declina ogni responsabilità per eventuali danni che possono, direttamente o indirettamente, derivare a persone, cose ed animali domestici, in conseguenza della mancata osservanza di tutte le prescrizioni indicate sui prodotti e/o sulle istruzioni per l'uso e/o per installazione. La ns. Azienda declina inoltre ogni responsabilità, qualora i prodotti fossero utilizzati per applicazioni speciali, o installati in posizioni per le quali si richiedesse l'ausilio di ponteggi, trabatelli o gru; non sono pertanto imputabili alla ns. Azienda costi di disinstallazione o sostituzione, in caso di eventuali difettosità dei prodotti.

## PROPRIETÀ INTELLETTUALE

La ns. Azienda si riserva i diritti, il titolo e la proprietà intellettuale su documenti, disegni, fotografie e schede fornite al Cliente. Il Cliente non potrà utilizzare tale documentazione, senza previa autorizzazione scritta della ns. Azienda, per la realizzazione di propri cataloghi, volantini promozionali, siti web o qualunque altro mezzo divulgativo e/o pubblicitario.

## FORO COMPETENTE

Per ogni controversia che dovesse sorgere tra la ns. Azienda ed il Committente, si intende eletto Foro competente quello della Ditta Venditrice.

# General terms of sale

## GENERAL INFORMATION

The general terms of sale below are valid for any order received from our Company and they are an essential part of each order. Any change to these clauses and any particular condition must be expressly agreed in writing.

## ORDERS

Orders acquired by our sale team are subject to our Company approval. Orders received with quantities less than the listed standards will be automatically rounded to the minimum packaging, otherwise they will not be managed.

## TRANSPORTATION

The goods travel is at Client risk. It's in his own interest to check, before withdrawal, the integrity of packages and quantity of received goods. Any complaint must be made directly to the carrier at delivery time and communicated to our Company, as stated in the chapter "Complaints".

## DELIVERY

The terms of delivery are purely indicative and have no contractual value. The shipment is carried out only with our trusted couriers. The delivery is intended to be made at the time the goods are delivered to the carrier. The delivery of the goods with emergency procedures and/or hydraulic bank, will be carried out only after acceptance by the Client of the additional cost related to the requested service. At delivery time, the Client undertakes to check immediately the quantitative compliance and integrity of the received packages as mentioned on Transport Document and the packing-list, even for deliveries with filmed pallets.

## WARRANTY

Our Company guarantees that the products are free of manufacturing defects for a period of 2 years from the date of delivery to the Client. The warranty will not cover products whose defects are due to:

- I** Damage caused during transport; (except what is described in the "Complaints" chapter).
- II** Lamps with broken glass (except what is described in the "Complaints" chapter).
- III** A negligent or improper use;
- IV** Non-compliance with the instructions of our Company regarding the use, maintenance and preservation of products;
- V** Repairs or changes made by the Client or third parties without the prior written permission of our Company.
- VI** In any case, the Client will not be able to claim the warranty rights to our Company if the price of the products has not been paid under the agreed terms and conditions, even if the non-payment refers to products different from those for which the Client intends to make guarantee. Our Company does not recognize any guarantee regarding products compliance with the rules and regulations of countries not belonging to the European Union.

## COMPLAINTS

As long as the Client complaint is covered by the warranty and notified in the below terms, our Company will undertake at its discretion to replace or repair each defective product or component. Any written complaint must be received by our Company within 8 days from delivery. Complaints about quantitative differences or damaged packages, or for broken lamps, should be highlighted on the Transport Document and the courier's letter. Any other way will be not accepted.

## RETURNS

All defective products can be returned after our permission only. Naturally it is necessary a first evaluation or check, then instructions from our Company to make the return will follow. Authorized returns must be sent to our warehouses with Transport Document and related purchase details. Products that have been used, even partially, cannot be considered defective; in this case, the convenience of replacing the damaged component will be evaluated, at Client cost. It should be noted that the term "defective" means any product that has not been used and has obvious manufacturing and/or operating anomalies.

Broken glass lamps do not fall within the field of defectiveness. Other products can be returned by our permission only, freight prepaid, as communicated by the claim's office at the time of the request. The price paid for the product will be refunded except 10 % charged for control, repackaging and repositioning in stock. Requests for returns of goods delivered more than 24 months before the claim will not be considered.

## PAYMENTS

Payments must be made to our Company at the fixed deadline for the agreed amount and addressed only to our administrative headquarters. In the event of a delay in the payment, even partial, beyond the agreed deadlines, the Company reserves the right to suspend subsequent deliveries of goods. Bank fee will be counted for the delay on the agreed payment according to the current legal arrangements.

## PROPERTY OF GOODS

Our Company remains the owner of the goods until the Customer pays for them in full.

## SIZES AND DESIGNS

Technical drawings related to the construction of products, dimensions, technical and/or photometric characteristics on any publication of our Company, have to be understood as informational and may be subject to change without any notice. For the latest product information, visit: [www.century-italia.com](http://www.century-italia.com).

## RESPONSIBILITY

The products must be used and/or installed in accordance with their technical characteristics and instructions, in accordance with the safety regulation in the country of use and/or installation. Our Company disclaims any liability for any damage that may, directly or indirectly, result from people, things and pets, as a result of non-compliance with all the requirements stated on the products and/or instructions for use and/or for installation. Our Company also disclaims any responsibility if the products are used for special applications, or installed in locations for which scaffolding, beams or cranes are required; costs of uninstallation or replacement, in case of any product defect, are therefore not charged by our Company.

## INTELLECTUAL PROPERTY

Our Company reserves the rights, title and intellectual property on documents, drawings, photographs and datasheets provided to the Client. The Client can't use this documentation – without prior written permission from our Company – for the creation of its own catalogues, promotional flyers, websites or any other means of dissemination and/or advertising.

## PLACE OF JURISDICTION

For every dispute that arises between our Company and the Client, the place of jurisdiction is intended to be the Seller's one.

Il presente documento potrebbe includere inesattezze tecniche o errori tipografici che verranno corretti a esclusiva discrezione della CENTURY® non appena rilevati. CENTURY® si riserva inoltre il diritto di variare i contenuti del catalogo in qualsiasi momento, senza preavviso. Con la tecnologia attuale non è possibile mostrare l'esatta qualità delle immagini dei prodotti come nella realtà. Le immagini presentate pertanto sono solo a scopo illustrativo e per finalità promozionali.

Tutti i contenuti presenti su questo documento, nonché il design dello stesso, appartengono unicamente a CENTURY® oppure a società collegate e sono protetti dalla normativa dettata in materia di tutela della proprietà intellettuale e del diritto d'autore. È pertanto vietato modificare, copiare, riprodurre, distribuire, trasmettere o diffondere senza autorizzazione ogni suo contenuto.

This document may include technical inaccuracies or typographical errors which will be corrected exclusively by CENTURY® as soon as detected. CENTURY® also reserves the right to change the contents of the catalog at a time, without notice. With current technology it is not possible to show the exact image quality of the products as in reality. The images presented are therefore for illustrative and promotional purposes only.

All the contents present on this same document, as well as the document by the same author, or individually to associated companies and are governed by the legislation on the protection of intellectual property and copyright. It is therefore forbidden to reproduce, transmit, transmit or release any of its contents without authorization.





XCL-LED



9 090171 012590



**CENTURY ITALIA S.R.L.**

Strada Tor Tre Ponti, 68 - 04100 - LATINA - ITALY  
Tel. +39 0773 24 27 08 - +39 0773 24 47 68 - Fax +39 0773 24 27 09  
[www.century-italia.com](http://www.century-italia.com) - [info@century-italia.com](mailto:info@century-italia.com)